



RESCUE
TECH
TECHNICAL RESCUE GEAR

QUALITY GEAR THAT
HELPS YOUR TEAM
DO MORE.

\$2.00

PRODUCT INDEX

ACCESS™ Lifeline	2, 3	Knives	136, 153	Rope, Sewn Eye	4, 5
ADVANTAGE G2 Harness	27	Lanyards	73, 74	Rope, Utility	8
Anchor Plates	55	Lights, Dive	139, 150	RUTH LEE™ Manikins	98 - 106
ARACHNIPOD Multipod	76 - 81	Lights, Handheld	139, 150	Search Kits	14, 15
Ascenders	47, 48	Lights, Strobe	139, 150	Seat Harness	21, 28
Backboards	93	Litter Bridles	90	Shock Absorber	71
Bags, Equipment	108 - 110	Litter Trailer	87	Slings, Webbing	70 - 75
Bags, Rope	12	Litter Wheel	87	Stretchers, Basket	87 - 89
Books, Rescue	142 - 144	Load Release Strap	72	Supplied Air Systems	160
Carabiners, Aluminum	36, 37	Manikins, Training	98 - 107	Swivel	40
Carabiners, Steel	34, 35	Mini-Haul Kit	66, 69	TASK STR-II Stretcher	95
Confined Space Rescue Kits	60	Multipod	76 - 81	Throw Bags	119
Cord, Prusik	5	Packs	108 - 112	Tower Rescue System	64
CORONA™ Escape Belt	22	Patient Handling	87 - 97	Tripod	77, 82, 83
D2 Escape Descender	17	Personal Flotation Devices	116 - 118, 133	VANGUARD™ G2 Harness	25
D4 Descender / Belay Device	51	PRIME™ Rescue Harness	26	Ventilation Equipment	159
D5 Descender / Belay Device	51	PROBE™ Search Line	6, 14, 15	Victim Harness	32
Descenders, Escape	17	Prusik Cord	5	Water Rescue Equipment	115 - 141
Descenders, Figure 8	53	Prusik, Sewn	5	Water Rescue Sled	131, 132
Descenders, Rack-type	54	Pulleys, Aluminum	41, 42	Webbing	8
Dry Suits	120	Pulleys, Knot Passing	45	Wetsuits	122
Edge Protection	8, 9	Pulleys, PMP	41 - 43	Winch, Rescue	84 - 86
EGRESS™ Escape Rope	7	Pulleys, Stainless Steel	43, 44	Winch, Tripod	82
Equipment Packs	108, 109	Pulleys, Swivel	46	Wristlet	31
Escape / Search Bag	16	Radio Harness	158	Webbing	8
Escape Belt	21, 22	R-ALF™ Rescue Kits	69	Winch, Rescue	84 - 86
Escape Kits	18, 19	Reach & Rescue Poles	124 - 126	Winch, Tripod	82
EXTRACTOR™ CSR Kits	65	Reeves Sleeve	96	Wristlet	31
Fall Protection Devices	83	Rescue 8 Descender	53	PRODUCT SECTIONS	
Fire Resistant Manikin	99, 102	Rescue Cradle	32	Rope	2
Firefighters' Rescue Kits	23, 24	Rigging Hardware	55, 56	Bags and packs	108
Flexible Stretcher	95 - 97	Rigging Plate	55	Fire rescue Harnesses	21
Gloves, Dive	123	Rigging Slings	70 - 72	Hardware	34
Gloves, Rescue/Rappel	151	RIT Drag Bags	13	Rescue kits	59
HALO Rigging Anchors™	55	RIT Kits	15	Slings and lanyards	70
Harness, Confined Space	25	River Board	132, 134	Arachnipod	76
Harness, Escape	21	Rope & Equipment Bags	12	Patient transport	87
Harness, Fire Resistant	21, 22	Rope Pad	8	Manikins	98
Harness, Rescue	25 - 29	Rope, ACCESS™ Lifeline	2, 3	Equipment bags/packs	108
Hauling Kits	62	Rope, Dynamic	4	Water rescue	115
Headlamps	148, 149	Rope, Fire Resistant	6, 7	Protective wear	145
Helmets, Rescue	145 - 147	Rope, Polypropylene	4		
Helmets, Water	127, 133	Rope, Rescue	2 - 4		
Kits, Rescue	59 - 69				

Ordering Instructions

1. Use catalog numbers and descriptions. This will help us correctly and promptly fill orders.
2. Remember to indicate size, color, and length, where applicable.
3. We ship UPS but will mail parcel post or utilize motor freight at the request of our customers.
4. Order line: 800-334-3368, for information call (770) 832-9694. FAX (770) 832-1676.
5. Our office hours are 9:00 a.m. - 5:00 p.m. (eastern). FAX operates 24 hour per day.

NOTICE: By placing an order the customer acknowledges agreement with the terms and conditions stated below, and acknowledges having read and understood the important warnings in this catalog. The customer further agrees that the laws of the state of Georgia shall apply to the purchase or any dispute arising therefrom.

Shipping Information

All products are sold F.O.B. shipping point. Shipping charges for retail customers inside the U.S. will be approximately 7% of merchandise cost: \$13.50 minimum. A \$8.00 charge will be added to COD shipments. A handling charge will be added to all shipments to cover insurance and carrier accessorial charges. Single items weighing over 70 lbs. will be shipped via most cost effective method.

Payment Policy

Purchase orders are accepted from government agencies, cities, and municipalities. Business and volunteer organization purchase orders are accepted if an open account has been approved by our credit department. All orders from individuals require Visa, Mastercard, COD, or check with order. Please allow time for your check to clear your bank. **Prices are in U.S. dollars and are subject to change without notice.** Sales tax is added to all orders shipped to Georgia addresses. Billing discrepancies must be reported within 10 days of invoice date. Returned checks subject to \$35.00 fee.

Damaged Shipments

If the shipping container is damaged, immediately open the carton and inspect the contents. Damaged shipments should be reported to the carrier immediately and not returned until instructions are received. DO NOT return the goods to us unless you have received a return authorization. Claims made more than 14 days after receipt of shipment may be denied.

Returns

Please call customer service at 770-832-9694 for a Return Authorization Number before returning any merchandise. Freight on returns must be paid by the purchaser. Absolutely no returns on "less than spool" or open stock quantities of rope or webbing products or custom/ special order / non-stock items unless the item was received in a damaged condition. A sized product may be exchanged for a different size if the returned item is in a re-sellable condition. Any return that is due to a customer error is subject to a 15% re-stocking fee. Any eligible return will be credited only after a full inspection of the product is completed.

Unconditional Guarantee

All merchandise offered in this catalog is returnable (in new condition) within 10 days, for any reason, for full refund credit less original shipping costs. CALL FOR RETURN AUTHORIZATION. Excludes cut lengths of rope or webbings and custom or special order products.

Limited Warranty

RESCUE TECHNOLOGY warrants to the original purchaser that products manufactured and/or sold by RESCUE TECHNOLOGY will be free from defects in materials and workmanship. This expressed warranty and all implied warranties imposed by law are limited to one year duration from the date of purchase. RESCUE TECHNOLOGY will repair or replace any product returned under warranty if, in RESCUE TECHNOLOGY's judgment, the product has not been misused or altered. No further warranties exist or are implied by RESCUE TECHNOLOGY due to the high risks involved in rescue services and in outdoor activities such as, but not limited to, mountaineering, rock climbing, rappelling, or caving, which can be reduced only through the skill, training, and judgment of the individual participant. RESCUE TECHNOLOGY shall not be liable for any and all consequential damages arising out of the breach of the expressed or implied warranties on sales by RESCUE TECHNOLOGY products. This limited warranty in no way limits or alters other manufacturers' warranties on products that are sold or distributed by RESCUE TECHNOLOGY.

NOTE: Some states do not allow limitation on how long an implied warranty lasts nor the exclusion or limitation of incidental or consequential damages, so the above limitations may not apply.

Liability Limits

Southeastern Safety Products, Inc. d/b/a Rescue Technology and Rescuetechn1, Inc. are not liable for any and all damages arising from abuse or improper use of equipment, failure to follow adequate safety precautions, or breach of the duty of either the purchaser, user, or bystander. Proper and adequate training, judgment, and competency are required to reduce the inherent risks in the use of rescue, safety and access equipment. The liability for the risks of use are solely that of the user and purchaser.

Product Modifications

RESCUE TECHNOLOGY reserves the right to modify, without notice, the specifications and price of products described in this catalog and the terms of sale. RescueTECH Trademarks Rigger, RT Rescue, Quadlock, ACCESS Lifelines, EGRESS Escape Rope, EGRESSHybrid Escape Rope, EGRESS-Nylon Escape Rope, PROBE Search Rope, PROBE-R Search Rope, PROBE-Hybrid Search Rope, PROBE-Nylon Search Rope, CORONA Escape Belt, VANGUARD, PRIME, and ADVANTAGE Rescue Harnesses are trademarks of Southeastern Safety Products, Inc. d/b/a RESCUE TECHNOLOGY. Other Trademarks Kevlar and Nomex are registered trademarks of E.I. Dupont Co. D2 Escape Descender, D4 Rescue Belay Descender, RED Backup, Rocker, are trademarks of International Safety Components.

Copyright April 2018
Rescue Technology
Carrollton, GA 30117
All rights reserved.



We proudly display this flag to designate equipment that is made in the U.S.A.

RESCUETECH MOVES FORWARD!

This year's catalog adds 8 more pages packed with quality technical rescue equipment. Our strategic partnership with ISC and Ruth Lee has produced many new items for the U.S. Market. New from ISC is the HaulerBiner Compact Mini-Haul. More versatile than a simple block and tackle with mini pulleys, the HaulerBiner has an integral progress capture that can be release without pulling more tension on the haul line. Ruth Lee has added new weights to their Fire and Rescue Training Manikins. Now, available in 176 lb. and 198 lb. versions for training in the most adverse conditions. The new Ligature and Full Body Airway manikins allow rescuers to implement EMS evolutions into their rescue training.

New Harnesses using ISC's CLIK-LOK buckles speed donning of full body harnesses. Look for the new VANGUARD-G2 and ADVANTAGE-G2. These new buckles are much stronger than competing quick-connect buckles.

We have also added the Reach and Rescue Water Rescue Pole Systems to our offering. With a maximum reach of 55 ft., these systems increase the safety of rescuers by keeping them out of the water.

All of us at RescueTECH look forward to working with you to help your team DO MORE!

STAY SAFE,

**GLENN NEWELL
PRESIDENT**



NEW PRODUCTS

NEW & IMPROVED AT RESCUETECH

UltraStatic Rope Access Rope

Double End Technora Prusik Sling 5
Triple9 Outdoor Trauma Kit 6

GRAPPLE - Speed Uniform Belt 21

VANGUARD-CLIK Harness 25

PRIME-CLIK Harness 26

Modern ICON K-9 Harnesses 30

Baby Rescue Bag 33

AD40 NFPA Aluminum Carabiners 36

Fireman Stainless Steel Carabiner 39

ISC Single Pulley w/ Becket 42

Rock Exotica 2.0 PMP Pulley 46

ISC PRO Handled Ascender 47

Rocker Adjustable Lanyard 50

RAD Positioning Lanyard 50

HALO Rigging Anchors 55

ISC Rigging Blocks 57

ISC Stryder Foot Ascender 57

ISC Deadweight Trolley 58

ISC Deadweight A-Frame 58

Bridgeport F.F. Rescue Kit 62

D2 Industrial Escape Kit 64

Tower Rescue System - Plus 64

ISC HaulerBiner 66

Harken Riggers Winch 500 86

Harken LokHead Winch 86

TASK STR II Stretcher 95



TASK H-STR II Stretcher

SLIX 100 Stretcher 95

Casualty Evacuation Manikin 100

K-9 Manikin 100

Ligature Manikin 100

Fire Marshal Manikin 102

Water-Fillable Bariatric Suit 102

Patient Handling Manikin 106

Full Body Airway Manikin 106

ZEN PFD 117

Reach & Rescue Pole System 124



Endurance ResqSled

Inflatable PWC Sled 132

R6C NFPA Rescue Helmet 145

Inflatable River Board 134

RS-1000 Ice Rescue Suit 133

USAR Manikin 102

251 BEULAH CHURCH RD.
CARROLLTON, GEORGIA 30117
800.334.3368
FAX 770-832-1676
EMAIL INFO@RESCUETECH1.COM
INTERNATIONAL 011-770-832-9694
WWW.RESCUETECH1.COM



WARNING

Technical rescue and safety is potentially hazardous. Any person using equipment sold by RESCUE TECHNOLOGY in any manner is personally responsible for learning the proper techniques involved, and assumes all risks and accepts full and complete responsibility for any and all damages or injury of any kind, including death, which may result from the use of any RESCUE TECHNOLOGY equipment

RESCUETECH ACCESS LIFELINE™ STRIPES



	Diameter		Color / Stripe	NFPA Tensile Strength*	WLL**	NFPA Rating	Wgt. / 100 ft
5157xxxOR	7/16"	11 mm	Orange w/ Yellow	7,870 lbf.	35 kN	525 lbs.	Technical 5.4 lbs.
5157xxxBL			Blue w/ Yellow				
5157xxxLG			Lime Green w/ Blue				
5157xxxRD			Red w/ Yellow				
5157xxxYE			Yellow w/ Blue				
5147xxxWB			White w/ Red				
5147xxxWR			White w/ Blue				
5158xxxOR	1/2"	13 mm	Orange w/ Yellow	10,000 lbf.	46 kN	667 lbs.	General 7.0 lbs.
5158xxxBL			Blue w/ Yellow				
5158xxxLG			Lime Green w/ Blue				
5158xxxRD			Red w/ Yellow				
5158xxxYE			Yellow w/ Blue				
5148xxxWR			White w/ Red				
5148xxxWB			White w/ Blue				
5159xxxOR	5/8"	14.5 mm	Orange w/ Yellow	11,405 lbf.	45.4 kN	760 lbs.	General 12.2 lbs.
5159xxxBL			Blue w/ Yellow				
5159xxxRD			Red w/ Yellow				
5159xxxYE			Yellow w/ Blue				

7/16" Color w/ Stripe

5157150xx	7/16" x 150'
5157200xx	7/16" x 200'
5157300xx	7/16" x 300'
5157600xx	7/16" x 600'

7/16" White w/ Stripe

5147150xx	7/16" x 150'
5147200xx	7/16" x 200'
5147300xx	7/16" x 300'
5147600xx	7/16" x 600'

1/2" Color w/ Stripe

5158150xx	1/2" x 150'
5158200xx	1/2" x 200'
5158300xx	1/2" x 300'
5158600xx	1/2" x 600'

1/2" White w/ Stripe

5148150xx	1/2" x 150'
5148200xx	1/2" x 200'
5148300xx	1/2" x 300'
5148600xx	1/2" x 600'

5/8" Color w/ Stripe

5159300xx	5/8" x 300'
5159600xx	5/8" x 600'

* Calculated as 3 standard deviations from the average tensile strength.

** WLL - Recommended Working Load (also known as Safe Working Load) is calculated using the NFPA 15:1 Safe Working Load Ratio.

TECHNOTE

NUMBER OF SHEATH STRANDS

The number of sheath strands affect the performance of a kernmantle rope. Fewer strands equate to a thicker sheath and can give a greater resistance to abrasion; but make the rope feel rough and may cause sheath slippage. More strands give the rope a smoother "feel". But, more strands mean a thinner sheath and may make the rope stiff; affecting the knot-tying performance. RescueTECH's kernmantle ropes take all factors of sheath design into consideration to give each type of rope, static or dynamic, the best of all handling characteristics.

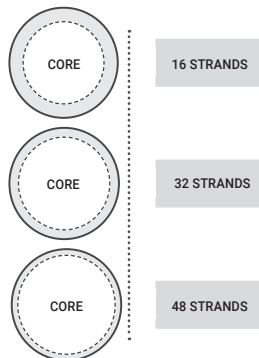

STRIPES VS SOLIDS

Different colors are very useful in distinguishing particular ropes during a rescue or training operation. The addition of stripes to ropes offers the rescuer the ability to see the movement of the rope. When two striped ropes are used side-by-side, the stripes act as index marks. If the stripes on the two ropes are not moving in relationship to each other, then the ropes are travelling at the same speed.

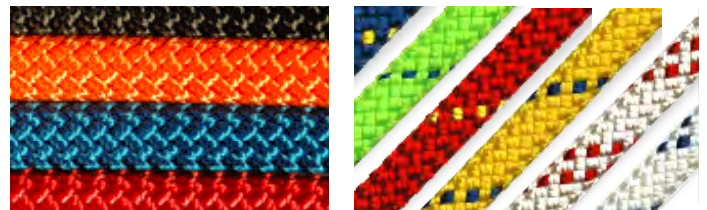

RESCUETECH ACCESS LIFELINE™ SOLIDS



RescueTECH spent 35 years helping design some of the best known rescue ropes in the world. Now, we have used our knowledge to create a rope design that gives the best combination of all desired characteristics. By building the ropes from the “ground up”, we are able to provide a super-strong rope with low stretch and excellent flexibility and knotability. By using a combination of a 32 strand polyester sheath and nylon core, our ropes actually handle better after 6 months of use than some new ropes from other manufacturers. We specifically address the issue of sheath slippage when constructing all of our top quality Rescue Ropes. Solution dyed color insures that colors won't run. All ropes of the same diameter will perform identically, making multi-rope systems much easier to control. Certified to NFPA 1983 and EN1891. Available in 11 color combinations.

	Diameter		Color	NFPA Tensile Strength*	WLL**	NFPA Rating	Wgt. / 100ft
5156xxxORS	3/8"	9.5 mm	Orange	6,070 lbf.	27 kN	405 lbs.	Technical
5156xxxBLS			Blue				
5156xxxRDS			Red				
5156xxxBKS			Black				
5157xxxORS	7/16"	11 mm	Orange	7,870 lbf.	35 kN	525 lbs.	Technical
5157xxxBLS			Blue				
5157xxxRDS			Red				
5157xxxYES			Yellow				
5157xxxBKS			Black				
5157xxxODS			Olive Green				
5158xxxORS	1/2"	13 mm	Orange	10,000 lbf.	46 kN	667 lbs.	General
5158xxxBLS			Blue				
5158xxxRDS			Red				
5158xxxYES			Yellow				
5158xxxBKS			Black				
5158xxxODS			Olive Green				

3/8" Solid Color

5156300xxx	3/8" x 300'
5156600xxx	3/8" x 600'

7/16" Solid Color

5157150xxx	7/16" x 150'
5157200xxx	7/16" x 200'
5157300xxx	7/16" x 300'
5157600xxx	7/16" x 600'

1/2" Solid Color

5158150xxx	1/2" x 150'
5158200xxx	1/2" x 200'
5158300xxx	1/2" x 300'
5158600xxx	1/2" x 600'

* Calculated as 3 standard deviations from the average tensile strength.

** WLL - Recommended Working Load (also known as Safe Working Load) is calculated using the NFPA 15:1 Safe Working Load Ratio.



ULTRASTATIC ROPE ACCESS LIFELINE

Ultrastatic is certified to EN 1891A and features exceptionally low stretch along with high static strength and excellent handling characteristics. Ultrastatic a great choice for work and rescue at great heights, use in rough environments of rescue and hoisting equipment, and for use as a rappelling aid.

Ultrastatic features:

- above average breaking strength
- exceptionally low stretch
- excellent UV stability
- good resistance to acids

Colors: Black, Red, Lime Green, White w/ Black

	Diameter		Length	NFPA Tensile Strength*	Wgt. / 100 ft.	WLL
5137000xxx	7/16"	11mm	foot	8,992 lbf.	40 kN	3.1 lbs.
5137300xxx			300 ft.			
5137600xxx			600 ft.			

TECHNOTE

PRUSIK CORD VS. ACCESSORY CORD

What is the difference between prusik cord and accessory cord? Generally, there is no difference. The key is to provide a cord that has specifications and characteristics that meet the needs of rescuers. Prusik cords work because of their flexibility that allows the initial engagement of the prusik hitch. Additionally, the diameter difference between the main line and the prusik cord is an essential element in the overall holding strength of the hitch.

ROPE END TERMINATION

We developed our rope end terminations after many years of research and development. Our first “knotless termination was a proprietary swaging method. Our process pressed the entire length of the aluminum ferrule rather than multiple 5/16” rings along its length. In response to requests to develop an end loop without the aluminum swages, RescueTECH developed a sewn-eye termination process. We are able to provide end terminations that exceed current NFPA strength requirements for rope-end terminations. The new Sewn-Eye ropes are lighter and more streamlined than the older Swaging process. All of our EXTRACTOR CSR™ Rescue Kits include the new sewn-eye ropes.



7/16" sewn eye

SEWN EYE LIFELINES

Available in 7/16" or 1/2"

RescueTECH's newest addition to our industrial lifelines. Lighter weight than swaged eyes, these lifelines provide strengths that meet NFPA and federal standards. Each lifeline is labeled with a unique production lot number. Made to order in our factory with quick turn-around.

Use only with rope grabs designed for kernmantle rope and that match the diameter of the rope selected.

	Rope Diameter	Length	Color	Tensile Strength
598751150xx	7/16"	150'	Blue, Orange, Red	6,300 lbf. 25 kN
598751150xx			White w/ Blue, White w/ Red	
598751200xx	7/16"	200'	Blue, Orange, Red	6,300 lbf. 25 kN
598751200xx			White w/ Blue, White w/ Red	
598851150xx	1/2"	150'	Blue w/ Yellow, Orange w/ Yellow, Red w/ Yellow	9,400 lbf. 41.8 kN
598851150xx			White w/ Red, White w/ Blue	
598851200xx	1/2"	200'	Blue w/ Yellow, Orange w/ Yellow, Red w/ Yellow	9,400 lbf. 41.8 kN
598851200xx			White w/ Red, White w/ Blue	



DYNAMIC ROPE

Highest Quality / Load Absorption

A dynamic rescue rope manufactured for special applications when climbing above the rigging point. Superior construction with the highest quality standards. High fall rating, low impact loads, increased resistance to abrasion. Special "DRY" water resistant coating helps keep this rope from absorbing water. Exceeds current UIAA and CE standards for dynamic ropes.

Strength: 5,500 lbf. EN 892.

		Diameter	Length	UIAA Tested As	Weight / meter	UIAA Falls Survived	Max Impact Load	80 kg Elong
5952165AM	Amber Mix	11mm	165 ft.	Single	75.2 gm	14	9.62 kN	4.8
5952165BL	Blue Mix	11mm	165 ft.	Single	75.2 gm	14	9.62 kN	4.8

WATER RESCUE ROPES



A B C D E F

PRO-POLY™ WATER RESCUE ROPE

100% Polypropylene

Kernmantle construction. Smooth sheath construction. Used in our Water Rescue Throwbags. Floats on top of water. Not recommended for rappelling or other heavy uses.

Color: Yellow w/ Red & Blue Stripes

7/16" WATER RESCUE ROPE

Nylon / Polypropylene

A special hybrid filament water rescue rope. Manufactured with a durable nylon sheath and a Multi-Filament Polypropylene core, this floating rope has a tensile strength of 5,000 lbf.

Color: Yellow w/ Red Stripes and Yellow w/ Blue Stripes

3/8" STANDARD POLY THROWLINE

100% Polypropylene

A throwline that gives rescuers an economic choice from the high-tech lines. Soft and easy to stuff and throw. 100% polypropylene solid braid.

Color: Yellow w/ Red Stripes

8MM NFPA THROWLINE

Polypropylene / Dyneema

UL Certified to NFPA 1983. Double braid construction of high strength core fibers covered in polypropylene to create a floating rope that meets the required strength specifications.

Color: Bright Yellow w/ Red Stripes

		Diameter	Strength	Rating
A. 516600	Pro-Poly	3/8"	2,960 lbf.	Throwline
B. 516700	Pro-Poly	7/16"	3,400 lbf.	Throwline
C. 50517000YR	Water Rescue	7/16"	5,600 lbf.	Throwline
D. 50517000YB	Water Rescue	7/16"	5,600 lbf.	Throwline
E. 50528000	NFPA Throw	5/16"	4,300 lbf.	Throwline
F. 230327000	Standard	3/8"	1,900 lbf.	



DOUBLE END TECHNORA PRUSIK SLING

Made with our 6mm PROBE aramid rope, this prusik design lends itself to more uses than a standard prusik loop. It may be used with a standard prusik, asymmetric prusik, Bachman, Valdotaire Tresse, or Klemheist hitches. When used with a Klemheist hitch, the PROBE Prusik will function on our 7.5mm EGRESS Personal Escape Ropes.

Length: 31" Strength (end-to-end): 2,270 lbf (10 kN) Strength (Basket): 4,555 lbf (20 kN)

751161310 Double End Technora Prusik Sling



PRUSIK SLINGS



Sling



Loop

PRUSIK LOOPS

RESCUETECH SEWN PRUSIKS

Our Product Development Department has worked hard to provide a durable sewn 8mm prusik for use in rescue systems. Two styles are available: Prusik Slings and Prusik Loops. Prusik Slings form 2 loops – one that will cinch down onto the carabiner. The Prusik Loops are sewn as a continuous loop. Our heavy duty stitching uses thread that is 150% thicker/stronger than other brands. Since not all PMPs are equally sized, we have created 2 sizes of Short Prusiks to work with the Long Prusiks. The stitches are covered with a transparent shrink tubing. Testing shows that a single RescueTECH Sewn Prusik pulled on RescueTECH's ACCESS 1/2" Life-line starts "clutching/slipping" at a strength of 3,000 lbf*. When pulled end-to-end the single loop strength exceeds 4,500 lbs. Marked with durable labeling to help product identification.

Best Fit Sizing: • For pulleys with sideplates up to 5" use the 18" and 28" Set • For Pulleys with sideplates up to 6.75" use the 20" and 30" set

* Results may vary depending upon brand and condition/age of the main rope.

		Length	Color
751180182	Prusik Sling, Short	18"	Yellow
751180202	Prusik Sling, Short	20"	Yellow
751180284	Prusik Sling, Long	28"	Red
751180304	Prusik Sling, Long	30"	Red

		Length	Color
751280182	Prusik Loop, Short	18"	Yellow
751280202	Prusik Loop, Short	20"	Yellow
751280284	Prusik Loop, Long	28"	Red
751280304	Prusik Loop, Long	30"	Red

Black Prusik:
4-8mm

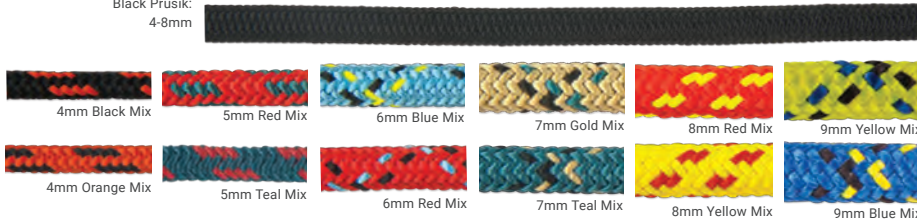

RESCUETECH PRUSIK CORDS

Prusik cords with the same high quality and long wear design as our Rescue Ropes. Size selection should be based upon diameter of main line.

Available by the foot or in Spool Lengths: 4mm / 5mm / 6mm x 300 ft.

7mm / 8mm / 9mm x 200 ft.



	Diameter	Strength	Colors	Main Line
5094000	4 mm	720 lbf.	Black, Black Mix, Orange Mix	5/16 - 3/8"
5095000	5 mm	1,200 lbf.	Black, Teal Mix, Red Mix	3/8"
5096000	6 mm	1,650 lbf.	Black, Blue Mix, Red Mix	7/16 - 1/2"
5097000	7 mm	2,300 lbf.	Black, Teal Mix, Gold Mix	1/2 - 5/8"
5098000	8 mm	2,900 lbf.	Black, Red Mix, Yellow Mix	1/2 - 5/8"
5099000	9 mm	3,670 lbf.	Blue Mix, Yellow Mix	5/8"

5MM TECH CORD

Tech Cord's small diameter and 5,000 pound strength are a result of using a uni-directional core of 100% Technora fibers and a tightly woven polyester sheath. Tech Cord is extremely strong and lightweight.

Colors: Green Mix, Blue Mix, Solid Black Strength: 5,000 lbf.

	Length
23910500	Tech Cord x ft.
23910550	Tech Cord x 50 ft.
239105660	Tech Cord x 660 ft.





PROBE-REFLECTIVE™ SEARCH LINE W/ SNAP
Reflective Stripe for Greater Visibility

Patterned after a major N.E. city's version, the RescueTECH Search Rope w/ Snap combine our PROBE-R™ Technora / Polyester Reflective Search Rope w/ our Double Locking Escape Snap and Swivel Trigger Snap. Durable I.D. labels are sealed under heat shrink tubing.

Strength: 2,400. lbf.

	Length	Weight
299722200	200'	3.6 lbs.
299722100	100'	2.4 lbs.
299722050	50'	1.2 lbs.



PROBE-REFLECTIVE™ FR SEARCH LINE

100% Heat Resistant Technora Sheath with Reflective Stripe

Constructed using the same materials as the standard PROBE™ Search Line with the addition of a 3M Scotchlite® retro-reflective stripe. Precut lengths are finished with a special sealant to prevent unravelling.

Strength: 2,400. lbf.

52716000R	PROBE-R™ x ft.
52716035R	PROBE-R™ x 35'
52716050R	PROBE-R™ x 50'
52716100R	PROBE-R™ x 100'



PROBE™ FR SEARCH LINE

Fire / Heat Resistant Sheath

6mm diameter Search Line with sheath made from Heat Resistant Technora fiber for extreme durability and resistance to heat (900° F). Firm, yet flexible, design is superior to "Hollow or Flat" braid construction. Maintains cross-section so cord can be easily felt on the floor. Precut lengths are finished with a special sealant to prevent unravelling.

Strength: 2,400 lbf.

52716000	PROBE™ x ft.
52716035	PROBE™ x 35'
52716050	PROBE™ x 50'
52716100	PROBE™ x 100'



PROBE FR1™ SEARCH LINE

Designed to provide a high-strength, low-profile search line that will fit into smaller packages. The PROBE FR1™ is a hollow braid 8mm searchline made from 100% Technora with yellow and orange markers.

Strength: 3950 lbf. (17.6 kN) Diameter: 8mm

	Length
54165000	Probe FR1 x ft.
54165035	Probe FR1 35'
54165050	Probe FR1 50'
54165100	Probe FR1 100'
54165200	Probe FR1 200'
54165300	Probe FR1 300'



WARNING

Technical rescue and safety is potentially hazardous. Any person using equipment sold by RESCUE TECHNOLOGY in any manner is personally responsible for learning the proper techniques involved, and assumes all risks and accepts full and complete responsibility for any and all damages or injury of any kind, including death, which may result from the use of any RESCUE TECHNOLOGY equipment



7.5MM EGRESS™

PERSONAL ESCAPE ROPE

100% Technora Sheath with Nylon Core

A new Heat Resistant Personal Escape Rope (P.E.R.) from RescueTECH™. We redesigned our original Escapeline to provide lighter weight and greater versatility. Perfect for your high temperature escape line needs. Precut lengths are finished with a special sealant to prevent unravelling.

Warning: Small diameter cords do not provide the same amount of rappelling friction as do larger ropes. Rescuers should practice rappelling with an 8mm cord to become familiar with the 8mm diameter lines. NFPA 1983 states that Personal Escape Ropes are for single use only.

Diameter: 7.5mm; Strength: 5,300 lbf.

		Length
		x ft.
52618000	EGRESS™ P.E.R.	
52618050	EGRESS™ P.E.R.	50'
52618070	EGRESS™ P.E.R.	70'
52618100	EGRESS™ P.E.R.	100'



7.5MM EGRESS+PLUS™

PERSONAL ESCAPE ROPE

100% Technora Heat Resistant

RescueTECH's superstrong, 100% Technora construction provides both sheath and core resistance to heat.

Diameter: 7.5mm Heat Resistance: > 900° Strength: 32 kN (7190 lbf)

Precut lengths are finished with a special sealant to prevent unravelling.

		Length
		x ft.
52628000	EGRESS+Plus™ P.E.R.	
52628050	EGRESS+Plus™ P.E.R.	50'
52628070	EGRESS+Plus™ P.E.R.	70'
52628100	EGRESS+Plus™ P.E.R.	100'

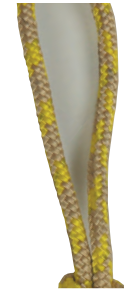

7.5MM EGRESS-HYBRID™

PERSONAL ESCAPE ROPE

New Aramid / Polyester Technology

The 7.5mm EGRESS-Hybrid™ rope is a blend of Technora and polyester fibers. The tough, heat-resistant aramid fibers in the sheath give the rope its strength and durability. While the polyester fibers lighten the weight and provide greater visibility. The end result is a strong, heat resistant cord that is lighter in weight and more economical than PER made from 100% aramid fibers.

Diameter: 7.5mm; Strength: 5,300 lbf.

		Length
		x ft.
52617000	EGRESS-Hybrid™ P.E.R.	
52617050	EGRESS-Hybrid™ P.E.R.	50'
52617070	EGRESS-Hybrid™ P.E.R.	70'
52617100	EGRESS-Hybrid™ P.E.R.	100'



8.5MM EGRESS-N™ PERSONAL ESCAPE ROPE

EGRESS-N gives firefighters an economic alternative to high priced aramid ropes. The 8.5mm EGRESS-N is certified to NFPA 1983 as a Personal Escape Rope.

Strength: 4,026 lbf.

		Length
		x ft.
52818000	EGRESS-N™ P.E.R.	
52818050	EGRESS-N™ P.E.R.	50'
52818070	EGRESS-N™ P.E.R.	70'
52818100	EGRESS-N™ P.E.R.	100'

TECHNOTE

WORKING LOAD LIMIT (WLL)

Working Load Limit (also known as Safe Working Load or Recommended Working Load) is defined as the maximum load that may routinely be applied to an assembly or component in straight tension. Two other strength terms are ultimate strength (or tensile strength) and Minimum Breaking Strength (MBS). Ultimate Strength is the load at which a component or assembly will fail in a test. Minimum Breaking Strength, as defined by NFPA 1983, is the result of subtracting three standard deviations from the mean result of the test lot.

We have chosen to use the NFPA ratio of 15:1 for ropes and the American engineering standard of 10:1 for critical use hardware and auxiliary equipment. We realize that these ratios may exceed proposed standards, but have selected them because they best apply to the rescue community. We show the Working Load Limit (WLL) because the ultimate strength may change during the life of the product. Whereas, the WLL will remain valid during the normal life of the product. For example, a 9,000 lbf. rope will lose tensile strength as it is used. However, the WLL will remain 600 lbs. throughout the normal service life of the rope. Additionally, rescue products should be chosen and matched based upon their WLL. The item with the lowest WLL limits the system working load limit. Remember, a chain is only as strong as its weakest link.

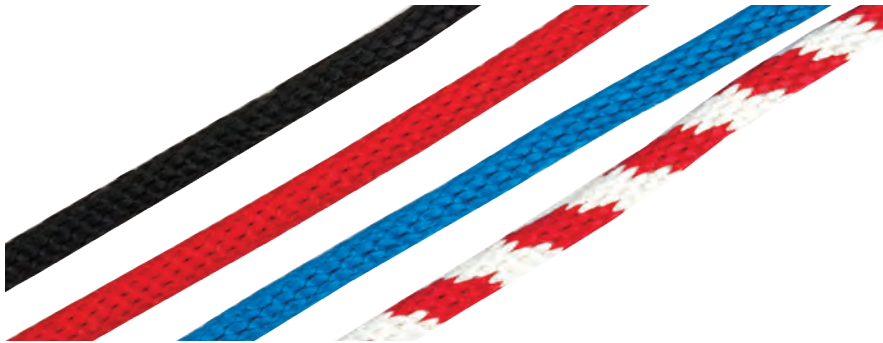

UTILITY / HOISTING LINE

100% Multifilament polypropylene for a myriad of utility use. Ideal for hoisting equipment. Soft, supple, easy to grip.

Strength: 4,000 lbf. WLL: 400 lbs. Diameter: 5/8" Colors: Black, Red, Blue, White w/ Red

NOT FOR LIFE SAFETY USE.

	Length	Colors
230319000xxx	Hoisting Line x ft.	Black, Red, Blue, White w/ Red
230319100xxx	Hoisting Line x 100'	Black, Red, Blue, White w/ Red
230319600xxx	Hoisting Line x 600'	Black, Red, Blue, White w/ Red

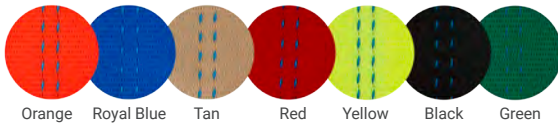

RESCUETECH WEBBING

RescueTECH Rescue-Spec Tubular webbing is specially designed for the demands of rescue by exceeding the strength specifications of normal mil-spec webbing. Additionally, it will outwear any comparably sized tubular webbing. Special Lock-Stitch is used to make RescueTECH tubular webbing superior to all other tubular webbing - even mil-spec. For heavy duty rigging conditions, we recommend the use of our Rescue Technology Heavy Duty Flat Webbing. The Heavy Duty Webbing is more abrasion resistant than standard 1" tubular.

		Strength	Colors Available
7900xx	9/16" Tubular	2,299 lbf.	Black, Lime Green, Royal Blue
7901xx	1" Tubular	4,200 lbf.	Black, Blue, Green, Orange, Red, Yellow, Tan
7902xx	2" Tubular	6,800 lbf.	Black, Blue, Red, Yellow
7945xx	1" Heavy Duty Flat	6,000 lbf.	Black, Blue, Green, Orange, Red, Yellow
7921xx	1.75" Heavy Duty Flat	6,000 lbf.	Black
7932xx	Seat Belt type Flat	6,000 lbf.	Black, Red



RESCUETECH ROPE GUARD

Super H.D. Cotton Duck Liner



Special protective sleeve made with super heavy cotton canvas. Outside of Rope Guard covered with heavy weight PVC fabric to protect from hazards and to provide distinctive color. Designed to protect ropes from abrasion when stretched across rough surfaces encountered in rappelling, rescue, high rise building maintenance, and other operations. Webbing loops are attached at each end to provide tie-backs to secure rope guard.

Color: Black, Red

	Size	Length
612412x	Small	12"
612418x	Medium	18"
612424x	Large	24"
612436x	XLarge	36"

Substitute "x" with Color Code: (1) Black, (4) Red



(Left) Wide Rope Pad (Right) Narrow Rope Pad with Velcro

RESCUETECH ROPE PAD

Super-Heavyweight Cotton Duck



Large 100% cotton rope pads are 2 layers thick in the center and use no synthetic material on its protective surface. Narrow pad with velcro will wrap around rope - secures with hook and loop fastener. Wide pad provides large area coverage. Both pads come complete with rigging grommets for tie-back cords.

Color: Natural

	Size	Dimensions
612101	Narrow	36" x 12"
612100	Narrow w/ Velcro	36" x 12"
612105	Wide	36" x 30"
612110	Extra-Long	36" x 60"
612111	Extra-Extra-Long	36" x 102"

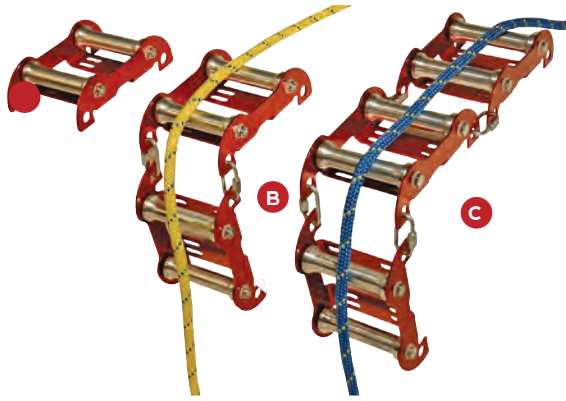

RESCUETECH MULTI-UNIT EDGE ROLLER

Rapid Link Connectors



The next generation edge protection device from RescueTECH. Featuring an alloy aluminum frame and rollers, this unit may be used as a single unit or paired-up with other units to provide large area protection using included rapid link. Low Profile design. All units 5.75" wide.

		Units	Length	Weight
A. 611111	Single	1	8.25"	1.6 lbs.
B. 611112	Double	2	17.75"	3.35 lbs.
C. 611113	Triple	3	26.50"	5.1 lbs.
D. 611114	Quad	4	35.25"	6.85 lbs.
60510106	6mm Connector Link			



RESCUETECH ONE PIECE EDGE ROLLER

Single Unit Edge / Roof Roller

Fully protects rope from corners and other points of friction. Uses aluminum rollers mounted on Oilite® bushings for extended wear. Alloy aluminum construction, steel fittings. Lightweight and low profile. Four connecting points for easy attachment and linking units together. Works best on 90 degree corners like window ledges or parapet walls. Can also be used as small diameter hose roller.

Tensile Strength: 10,000 lbf. Dimensions: 5" x 9" Weight: 27.2 oz. Color: Gold Rating: General Use

Exceeds NFPA 1983/ANSI/OSHA strength specifications.



ROPE ROLLER SET

3-side Rope Channel

A new edge roller system to protect ropes from damage when working over sharp edges. The system is fully modular, consisting of edge-roller boxes manufactured from high grade aluminum connected with steel rapid links. Each box has a series of rollers that protect the rope in three directions. Multiple sets can be "chained" to provide a long coverage area.

Individual Roller dimensions: 2.4" x 2" x 2" Maximum rope diameter: 1/2" (13mm)

		Length	Weight
201404093	Triple	10.5"	43 oz.
201404094	Quad	15"	59 oz.

611101

\$119.00



BORN ENTRY EASE

The Newest Single Unit Edge Guard

Excellent stainless steel edge guard gives the needed abrasion protection from sharp edges. Minimum entry size: 18" (45 cm). Works for confined spaces with limited overhead rigging availability. Compatible with stretchers and people over manholes, ladder rungs, railings, pipes or any surface in which the lifeline may become damaged.

Weight: 5 lbs (2.3kg)

249105225



ALL TERRAIN EDGE ROLLER



Manufactured with rollers turning on sealed ball bearings for incredibly smooth rope pulls. This low profile unit allows litters to be easily raised over the unit and will provide a smooth pull over various types of edges. The unit can be wrapped around objects and have the ends secured with carabiners. The unit folds up into a 7" cube for easy storage and deployment. The side plates are manufactured from a high strength aluminum alloy.

Dimensions: 22.25" x 7" x 2.25" Weight: 4.45 lbs.

20021101

All Terrain Edge Roller

ROPE ACCESSORIES

RescueTECH offers an array rope accessories that aid in the care and maintenance of all your rope products.



RESCUETECH EQUIPMENT I.D. TAPE

Used to identify ropes, carabiners, and other equipment. Can be sealed on ropes using Whip-End-Dip or Heat Shrink Tubing. Set includes 5 colors of vinyl tape.

Colors: Yellow, White, Red, Green, Blue Weight: 3.2 oz.

599930	Equipment Tape
--------	----------------



HEAT SHRINK TUBING

Clear heat shrink tubing for marking rope ends. Mark end of rope with tape, labels, etc., then slip tubing over end. Heat source shrinks tubing tightly around rope and marker. Sold by the foot.

	Rope Size	
599944	1/2"	Fits 3/8" and 7/16" ropes
599945	3/4"	Fits 7/16" and 1/2" ropes
599946	1"	Fits 5/8" ropes



PAINT MARKING PENS

Permanent opaque pigmented ink valve-action marker. Ink marks opaque and glossy on light or dark surfaces. Marks on virtually any surface: metal, wood, corrugated, rubber, plastic, glass, etc. Permanent opaque pigment ink resists sun's ultraviolet rays.

For metal parts. Not for use on ropes, harnesses, webbing or other life safety items made from synthetic fibers.

	Color
2435100	Orange
2435101	Black
2435102	Yellow
2435104	Red
2435105	Green
2435106	Light Blue
2435109	White



RESCUETECH ROPE MARKING LABELS

Self-laminating marking labels. Write or type information on the 1" x 3/4" label and wrap the clear laminating plastic over the white label. Suitable for ropes up to 5/8". The label can then be sealed to the rope with clear Whip-End-Dip. One book contains 60 labels.

Weight: 1.6 oz.

5999223	Marking Labels
---------	----------------



WHIP-END-DIP

Liquid vinyl compound that seals the end of your rope. Prevents fraying and unravelling. Also, needed information can be marked on an adhesive label then coated with Whip-End-Dip to protect markings.

Contents: 4 oz.

	Color
599900	White
599904	Red
599909	Clear

NAME / CREW		ROPE LOG		I.D. NUMBER	
NAME / CREW	DATE	ROPE LOG	DATE	I.D. NUMBER	DATE
RESCUE TECHNOLOGY	DATE	LOCATION	CONDITION	RESCUE TO	DATE

ROPE LOG SHEET

Printed on Rite-In-The-Rain All-Weather paper for durability. Sheets include generous space for date, call/rescue I.D., location, and conditions. Rescue Technology Rope Log Sheets also offer standardized Inspection Criteria "Check-offs" for each use. This helps ensure consistent inspection data for each use. Hole-punched for standard 3 Ring binders. Cover includes inspection criteria information as well as care and use information. Set includes 10 sheets that are printed on both sides giving space for 280 entries.

599303	Rope Log Sheet
--------	----------------



ROPE THIMBLE

Made from an almost indestructible polyolefin polymer that deforms rather than breaks under heavy load. Produces no sharp edges. Rope guards hold the rope in the guide grooves.

Weight: 1 oz.

	Fits rope diameter
5999246	3/8"
5999248	7/16", 1/2"
5999249	5/8"



ROPE WASHER

Device connects to standard hose for washing or rinsing ropes. Best on light dirt or for rinsing washed ropes.

	Size	Fits rope dia.	Weight
5999203	Standard	up to 1/2"	6.1 oz.
5999204	Large	up to 3/4"	8.8 oz.



RESCUETECH ROPE CLEANSER

Reformulated to clean ropes better. Excellent for nylon, polyester, or polypropylene fibers. Excellent cleanser for Harnesses, Slings, and other webbing / fabric products. Concentrated formula can be diluted to suit the dirt or stain encountered.

Biodegradable.

	Size	Weight
599911	Pint	1.1 lbs.
599910	Concentrate for Gallon	4.4 lbs.



MESH WASH SACK

Great for rope washing, packaging slings, webbing, cords, and personal gear.

	Size	Dimensions	Weight
805401	L	30" x 15"	3.2 oz.
805406	XL	36" x 24"	5.6 oz.



DOBI ROPE BRUSH

Rope washing the easy way. Just put the rope inside the rope washer, add mild soap and water, and work the Dobi back and forth along the rope. The revolving bristles help to gently remove grime, dirt, and metal oxides from rope. Fits 3/8" – 1/2" ropes.

Weight: 3.2 oz.

5999211

Dobi Rope Brush

TECHNOTE

Please Remember...

A life is much more valuable than a piece of rope. So replace your rope if there is any doubt as to its condition. It is very important to practice proper usage guidelines on the use and care of your rope. Improper care and use of your rope could result in a serious injury or death.



ROPE CUTTING BOX

Ideal for cutting and sealing numerous ropes and webbing. Can be mounted to wall or workbench. Capable of cutting ropes up to 1" diameter. 120 volts AC. Blade is designed for longer use than standard blades.

Weight: 44 oz.

901020	Cutting Box
901025	Replacement Blade, Box



DOUBLE END ROPE BAG



Made from Cordura™ Nylon w/ grab and throw loops. Drawstring openings at both ends allow user to "rotate" the rope using both ends equally. Manufactured in U.S.A.

Color: Black

	Size	
804201	Small	150' of 1/2"
804301	Medium	200' of 1/2"
804401	Large	300' of 1/2"

BAGS & PACKS

We take pride in our bags and packs. Made in our factory in Carrollton, Georgia, you are assured of top quality products that will exceed your expectations. Our bags feature no exposed fabric edges that can unravel, reinforced and taped load-bearing seams, and designs that are function driven. Over the years, we have upgraded our shop to include programmable sewing machines, heat presses, and embroidery machines that let us make bags that are rescue-purpose built.



• Ergonomic Padded Shoulder Straps • Molded Rubber Carry Handle

REFLECTIVE PVC ROPE BAG

Shoulder Straps and Molded handle



As durable as it is visible at night. Manufactured of 14 oz. nylon reinforced PVC fabric and an 18 oz. nylon reinforced PVC Fabric bottom.

Dimensions: Small: 18" H x 10" D Medium: 20" H x 10" D Large: 18" H x 12" D

	Size	
802204	Small	200 ft. of 1/2"
802304	Medium	300 ft. of 1/2"
802404	Large	500 ft. of 1/2"



RESCUETECH ROPE BAGS

Super-Durable Construction

Constructed of heavy duty water resistant Cordura™ nylon and nearly-indestructible Ballistic Nylon fabrics. Side seams of bags are double-stitched so that no fabric edges are exposed for fraying. Bottom seam is double stitched and webbing reinforced for superior strength and resistance to abrasion. Drawstring closure with cord lock. Accommodates rope (capacities listed) or equipment. All units except personal size have log book pouches and grommets in bottom to permit drainage. Handles connected to interior of bag to aid in rope loading.

• Double Stitched and Taped Bottom Seam • Double Stitched • Side Seam • Tough 1000 Denier Cordura® Body Durable Ballistic Fabric Bottom • No Exposed Fabric Edge to Unravel • Drainage Grommet in Bottom • Heavy Duty Cord-Lock Adjusts Drawstring • Interior Log Pouch



		Capacity			Dimensions Open	Handles	Shoulder Straps	Colors
		7/16"	1/2"	5/8"				
80111x	Personal	45'			10" x 6"	2	n/a	OR, BK, BL
80121x	Small	175'	125'	75'	12" x 10"	2	n/a	OR, BK, BL, RD, YE, GR
80131x	Medium	300'	225'	125'	20" x 10"	2	1	OR, BK, BL, RD, YE, GR
80141x	Large	400'	325'	200'	26" x 10"	2	2	OR, BK, BL, RD, YE
80151x	XLarge	600'	400'	250'	20" x 14"	2	2	OR, BK, BL, RD
80161x	Super	750'	600'	325'	26" x 14"	2	2	OR, BK, BL
80171x	Jumbo	1150'	900'	500'	26" x 17"	2	2	OR, BK

Replace X: 0= Orange; 1=Black; 2=Yellow; 4=Red; 5=Green; 6=Blue.

ROPE AND EQUIPMENT BAGS

With Attached Equipment Pockets and Padded Shoulder Straps

Constructed of heavy duty water resistant Cordura™ nylon and nearly-indestructible Ballistic Nylon fabrics. Side seams of bags are double-stitched so that no fabric edges are exposed for fraying. Bottom seam is double stitched and webbing reinforced for superior strength and resistance to abrasion. Drawstring closure with cord lock. Accommodates rope (capacities listed) or equipment. Handles connected to interior of bag to aid in rope loading.

Rope capacity:

Medium: 20"h x 10"d fits 7/16"- 300 ft. or 1/2"- 225 ft. Large: 25"h x 10"d fits 7/16"- 400 ft. or 1/2"- 325 ft.

	Size	Color
807434	Medium w/ 1 Pocket	Red
807436	Medium w/ 1 Pocket	Blue
807431	Medium w/ 1 Pocket	Black
807444	Large w/ 2 Pockets	Red
807446	Large w/ 2 Pockets	Blue
807441	Large w/ 2 Pockets	Black



RIT*2 EMERGENCY SCBA PACK
Heat Resistant Multi-Use RIT Packs



The RIT*2 Emergency SCBA Pack is the logical evolution of our popular Deluxe SCBA Pack. The outside shell is manufactured from RescueTECH's proprietary heat-resistant fabric. Comprised of 6 compartments, this pack will hold what your team needs for Rapid Intervention operations. Main Compartment designed for a full SCBA Backpack. Search line pouch holds 200 ft. of 8mm Searchline. Mask pouch and long pocket have hose "pass-through" to the padded main compartment. One 20" and two 10" side compartments holds tools and individual search line bags. Pack features included L.E.D. Strobe for extra visibility. Easily replaceable Skid Plate extends life of the bag. Custom labelling available.

Dimensions: 32" L x 12" W x 12" D Weight: 7.7 lbs.

(Above)

- A. Shoulder Strap made from Rescue-Grade Heavy Duty Kevlar web, steel adjuster, and aluminum carabiners (included). Can convert to 26" long loop, 52" long single point sling, or can be detached and used as a downed firefighter rescue sling.
- B. One Large External Gussetted Tool Pouch has two full-length compartments to hold buddy air hose and breaching tools. Special pass-through slot is ideal for pre-rigged buddy or quick-fill airlines. Also shown is the optional Embroidered "RIT" Label.
- C. Bag Made from RescueTECH's proprietary Heat Resistant Fabric.
- D. High Temperature Retro-Reflective Strips



- 1. Mask Pouch fits masks with extra-long air hose. Pass-through slot to the main compartment allows pre-rigging of airlines and rescue without opening main compartment.
- 2. Drag Handles on Both Ends are easy to use with Structural Gloves.
- 3. Zippered Searchline Pouch for Easy Stowing of up to 200 ft of 8mm PROBE™ Searchline.
- 4. We originated the Skid Plate for RIT Bags in 2003 and still make the best. Our Skid Plate is heavy duty 1/8" Haircell Polyethylene to increase durability. We take the time to pre-contour the Skid Plate to allow the bag to ride up and over obstacles. The extra width helps prevent bag roll-over.
- 5. Two Small External Gussetted Tool Pouches hold extra search equipment.

Equipment not included.

299625104	RIT*2 Pack
80899501	RIT Label
299625104S	RIT*2 Skid Plate, Replacement

DELUXE RIT EMERGENCY SCBA PACK

Includes 2 Full-Length Exterior Tool Pouches and Skid Plate



The Deluxe RIT Emergency SCBA Pack is the next generation in multi-use RIT Packs. Comprised of 5 compartments, this pack will hold what your team needs for RIT operations. Main Compartment designed for a full SCBA Backpack. Search line pouch holds 200 ft. of 8mm Searchline. Mask pouch has a regulator hose "pass-through" to the padded main compartment. 20" side compartments hold tools and individual search line bags. Pack features included L.E.D. Strobe for extra visibility. Replaceable Skid plate extends life of the bag. Made from high strength coated nylon fabric.

Dimensions: 32"L x 12"W x 12" D

Equipment not included.



299625103	Deluxe RIT Pack
299625103S	Skid Plate, Replacement

- A. Mask Pouch w/ Drag Handle
- B. High Temperature Retro-Reflective Stripes.
- C. Zippered Searchline Pouch for Easy Stowing
- D. Two 22" External Gussetted Tool Pouches.
- E. Heavy Duty 1/8" Haircell Polyethylene Skid Plate for Extra Wear Protection.



Technical rescue and safety is potentially hazardous. Any person using equipment sold by RESCUE TECHNOLOGY in any manner is personally responsible for learning the proper techniques involved, and assumes all risks and accepts full and complete responsibility for any and all damages or injury of any kind, including death, which may result from the use of any RESCUE TECHNOLOGY equipment.



PROBE™ Search Line w/ Snap



PROBE™ SEARCH LINE KITS
Heat-Resistant Design

6mm cord with heat resistant Technora sheath (Temp 900°F). 6mm cord can be felt on ground unlike units made with flat webbing. Bags are specially designed for easy deployment with structural gloves. Autolocking Fixed Eye Snap prevents accidental detachment of carabiner from its anchor. Fixed Eye prevents PROBE™ Search line cord from becoming detached from carabiner. Search Bag manufactured with RescueTECH's proprietary heat resistant fabric. Retro-reflective tape increases visibility of bag. Notice: PROBE™ search cord is not NFPA Personal Escape Line and cannot be used for a Personal Escape rope.

	Length
29985035	35'
29985050	50'
29985100	100'



PROBE-R™ SEARCH LINE KITS
Heat-Resistant with Reflective Stripe

The same high quality materials and design as our original PROBE™ Search Line with 3M Scotchlite® added to the sheath. Provides extra visibility of Search Lines during fire operations. Search Bag manufactured with RescueTECH's proprietary heat resistant fabric. Notice: PROBE-R™ search cord is not NFPA Personal Escape Line and cannot be used for a Personal Escape rope.

	Length
29985035R	35'
29985050R	50'
29985100R	100'



PROBE-Hybrid™ Search Line

PROBE-Hybrid Kit shown with Snap deployed and ready to use



PROBE-HYBRID™ KITS
New Hybrid 6mm Searchline Cord

Assembled with a new hybrid 6mm cord. The cord's sheath is manufactured using both heat resistant aramid fibers (Temp 900°F) for fire resistance and polyester for lighter weight. The 6mm round cord can be felt on ground unlike units made with flat webbing. Bags are manufactured of RescueTECH's proprietary fire resistant fabric, hook and loop fastener, nylon webbing and features Scotchlite® retro-reflective striping. Bag is specially designed for easy deployment with structural firefighting gloves. Autolocking Fixed Eye Snap prevents accidental detachment of carabiner from its anchor. Fixed Eye prevents Searchline cord from becoming detached from carabiner. Retro-reflective tape increases visibility of bag. Notice: PROBE-Hybrid™ search cord is not NFPA Personal Escape Line and cannot be used for a Personal Escape Rope.

	Length
29985035H	35'
29985050H	50'
29985100H	100'



100 ft. model shown



BASIC SEARCH KITS
Now Available with Captive Eye Carabiner

A basic Search Kit featuring our 7mm Nylon SearchLine cord. These kits offer a protective search line at an economical price. Cord is stored in our durable Escape / Search Bags made from Cordura and Ballistic Fabrics. Autolocking Aluminum Search Snap at end of cord can be clipped to rigging point or back onto search line. Bag attaches to waist belt of SCBA or Rescue harness or worn on shoulder with attached strap. Kit includes Bag, Cord, and Carabiner. Notice: PROBE-Nylon™ search cord is not NFPA Personal Escape Line and cannot be used for a Personal Escape rope.

	Length
299813035	35'
299813050	50'
299813100	100'



PROBE FR1 SEARCH KIT

The PROBE FR1 Search Kit combines our top quality search pouches with our new 8mm PROBE-FR1 Search Line. 8mm PROBE-FR1 is a high-strength, low-profile line that will fit into smaller packages. Search Bag manufactured with RescueTECH's proprietary heat resistant fabric.

29986035	35'
29986050	50'
29986100	100'



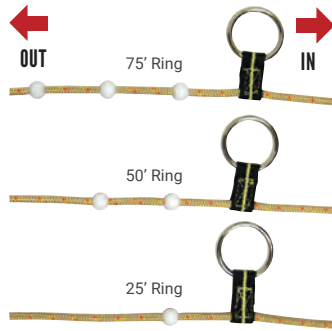

Individual Search Lines attach to rings



MARKER™ SEARCH ROPE KIT
Complete with 2" Rings and Directional Marking

At the request of a major Texas city, RescueTECH designed a special "Master" pack for their RIT teams. Durability and quality are prime considerations with this pack. Durable Cordura Nylon fabric with removeable, quick-release shoulder strap. The pack also features "daisy chain" web loops on the shoulder strap and reverse side of pack. The kit has 200 feet of our 7.5mm RescueTECH EGRESS-Hybrid™ or EGRESS+Plus™ search rope complete with 2" rings every 25 ft. The Rope is also marked with 3/4" nylon balls to indicate distance and direction (ex. 3 balls = 75 ft.). Using the phrase "Ring, then Bump = Out to the Pump", a firefighter can identify direction and distance to the exit. Kit includes 200 ft. with Autolocking snap sewn to each end and a Searchline Shoulder bag with quick release seatbelt buckles. 200 ft. Marker™ rope is also available as a separate item.

299824200	Marker+PLUS™ Search Rope Kit, 200'
299823200	Marker-H™ Search Rope Kit, 200'
299724200	Marker+PLUS™ Search Rope Only, 200'
299723200	Marker-H™ Search Rope Only, 200'



MARKER GROUP SEARCH KIT™

Our ATX Group Search Kit was designed for a major TX city to fulfill their Large Area Search needs. The Kit is set up for a four person RIT team and provides a means of marking location and a guideline to the outside. Comprised of one Marker Search Rope Kit (see above) and individual search line kits with heat resistant bag. The 200' Marker Search Rope has nylon balls affixed to the rope to mark distance - no knots to slip or snag. The individual search kits are equipped with an autolocking, strength-rated aluminum hook that is fixed to the end of the rope without knots. Search kits can clip to webbing loops on master kit and can either be hung from belt or SCBA frame or can be slid onto waist belt. Search kits feature quick-disconnect strap if threaded on waist belt. Available in 4 and 5 person kits in either 35 ft. or 50 ft. Personal Search kits.

		Length
29982016135	4 person Kit - 1 master / 3 Search	35'
29982016235	5 Person Kit - 1 master / 4 Search	35'
29982016150	4 person Kit - 1 master / 3 Search	50'
29982016250	5 Person Kit - 1 master / 4 Search	50'



SearchLine Master Pack™ shown with two (2) 100 ft. Master Lines and six (6) 35 ft. Search lines



SEARCHLINE MASTER PACK™
4/6/8 Person RIT Search Line Set

A Searchline Set ready to deploy for Rapid Intervention. The Master Pack consists of a high quality carrying bag made from 1000 den cordura, Ballistic Cloth, and closed cell foam. Zippered inside pouches can hold items up to 18" in length. Extra room in main compartment can hold tools up to 22" long. The pack contains two (2) 100 foot master deployment lines and six (6) search lines (select 35 ft. or 50 ft. models.) Available with PROBE™ Heat Resistant Aramid Search Line or PROBE-R™ Heat Resistant Search Lines w/ Reflective Stripe.

Dimensions: 23"L x 12"W x 8"D

		Length
29982006135	Probe™	35'
29982006150	Probe™	50'
29982006235	Probe™ - Reflective™	35'
29982006250	Probe™ - Reflective™	50'
29961800	Master Pack, Carrying Bag Only	



ATX MASTER SEARCH PACK

The pack we designed for our Marker Search Rope Kit and ATX Group Search Kit is now available as a separate item. Durable Cordura Nylon fabric with removeable, quick-release shoulder strap. Features "daisy chain" web loops on the shoulder strap and reverse side of pack. ATX Master Pack holds up to 200' of 7.5mm cord. Kit Includes Pack and 200 ft. of PROBE-Reflective Searchline with double locking snap.



		Color
800120041	ATX Master Search Pack	Black
800120042	ATX Master Search Pack	Yellow
29981222001	ATX PROBE-R Search Kit	Black
29981222002	ATX PROBE-R Search Kit	Yellow
8001295	Double Snap Shoulder Strap	Black

RESCUETECH ESCAPE/SEARCH BAGS

RescueTECH designed our Escape / Search bag to be multi-functional. The Velcro closure secures the content against accidental deployment. The bags are constructed to allow users to clip them to a harness or airpack using the steel "D" rings or thread it onto a waist strap. A quick-release function will detach the bag from a waist belt with a simple pull of the release tab. Heat Resistant retro-reflective stripes increase user visibility. Available in Fire Resistant (red) or Nylon (orange) fabrics.



Front equipment pouch separates hooks and snaps from rope.

Quick-Release Belt Snap System

NYLON ESCAPE / SEARCH BAG



Lined, 2-Layer construction for extra strength and durability. All seams double stitched for extra durability.

Color: Orange

Equipment not included.

	Size	Fits Length	Closed Dimensions
8001310	XS	25'	5" x 6" x 3"
8001320	S	35'	6" x 6" x 3"
8001330	M	50'	7" x 6" x 3"
8001340	L	70'	9" x 6" x 3"

HEAT-RESISTANT ESCAPE / SEARCH BAG



Heat Resistant Outer Shell

A new design for drop bags featuring a lined, 2-layer construction that protects cord while easing access with structural gloves. Attaches to harness waist belts. All seams double stitched for extra durability. D2 sized bags required for use with the D2 Escape Descender.

Color: Red

Equipment not included.

	Size	Fits Length	Closed Dimensions
8001414	XS	25'	5" x 6" x 3"
8001424	S	35'	6" x 6" x 3"
8001434	M	50'	7" x 6" x 3"
8001444	L	70'	9" x 6" x 3"
8001634	D2-M	50'	8" x 7" x 4"
8001644	D2-L	70'	10" x 7" x 4"



NYLON DROP BAG

Durable 1000 denier Construction



Designed to hold our 8mm EGRESS™ Personal Escape Rope and PROBE™ Search Line kits, this Drop Bag is perfect to "create-your-own" rescue kit. Hinged Lid with snap closure. Retro-reflective tab makes this bag highly visible and easy to open with structural firefighting gloves. Attaches to Escape Belt and Harnesses.

Color: Red

Equipment not included.

	Size	Fits Length	Closed Dimensions
800520	S	35' of 8mm Cord	9" x 6" x 3"
800521	M	70' of 8mm Cord	10" x 7" x 4"
800522	L	100' of 8mm Cord	12" x 7" x 5"



RESCUETECH SEARCHLINE SHOULDER BAG

Holds 200 ft. of 6mm search cord



A new "Over-the-Shoulder" bag that easily holds up to 200 ft. of PROBE™ Search Line. Manufactured of tough Ballistic Nylon to a major Texas city's specification. Inside strap system pre-tensions the cord for an even deployment. Adjustable shoulder strap may be worn on one shoulder or across the body.

Dimensions: 11" x 9" x 5" Weight: 4.9 lbs.

800121	Searchline Shoulder Bag
--------	-------------------------



WARNING

Technical rescue and safety is potentially hazardous. Any person using equipment sold by RESCUE TECHNOLOGY in any manner is personally responsible for learning the proper techniques involved, and assumes all risks and accepts full and complete responsibility for any and all damages or injury of any kind, including death, which may result from the use of any RESCUE TECHNOLOGY equipment



ESCAPE 8



A compact Escape descender with ears for quick personal escapes. Rescue "ears" are situated to provide a compact Rescue 8 design for escape systems.

Dimensions: 2 7/8" x 2 3/4" **Strength:** 3,150 lbf. **WLL:** 300 lbs. **Weight:** 4 oz. **Rating:** General Use.

Meets NFPA 1983/ANSI construction specifications for Descenders.

20016011

Color
Black



RT Escape Descender shown in one of many friction settings.

ESCAPE DESCENDER



Special descender plate with multiple friction holes that allow a small diameter escape cord to be rigged to accommodate different amounts of friction. ALWAYS test your personal rigging method to assure sufficient friction for a safe descent. Works with 8mm to 11mm diameter escape lines.

Dimensions: 4" x 2.75" **Tensile Strength:** 5,000 lbf. **Weight:** 3.2 oz. **Rating:** General Use.

Meets NFPA 1983/ANSI construction specifications for Descenders.

601005

Escape Descender

D2 ESCAPE DESCENDER

Our newest Escape Descender for our EGRESS escape ropes. Allows for quick deployment and adjustment before the bail out. Rotating Handle provides exception control. Double Stop for safety. The D2 is a true panic stop device rather than a panic brake device. The difference is that once the panic brake is activated, no other force must be applied to the device. A panic brake style device requires a force input to continue the braking function. Also works well as an emergency lowering device.

Dimensions: 5.7" x 2.85" **Rope Diameters:** 7 – 8mm **Load Range:** 100 – 300 lbs.



201404024
201404021

Color
Red
Black



AUTOLOCKING ALUMINUM SNAP HOOK

The Autolocking Aluminum Snap Hook was selected by RescueTECH for use in our EGRESS Escape Kits and PROBE Searchline kits because of its ease of use and dependability. Manufactured of forged aluminum, the autolocking gate is easy to open with structural firefighting gloves. New frame design incorporates feature that protects locking mechanism.

Colors: Grey/Red (shown), Black **Dimensions:** 5.5" x 2.75" (137.5 x 68.8mm) **Strength:** 6,070 lbf. (27 kN) **Weight:** 4 oz. (108 gm) **Gate Opening:** .88" (22 mm)

20149014
20149011

AutoLock Snap Hook
AutoLock Snap Hook

Color
Grey/Red
Black



CROSBY ESCAPE HOOK

Certified to NFPA 1983

The escape hook is to be used as an anchor in an engineered system for firefighter escape applications or as a component of a system specifically designed by a qualified person for firefighter escape. The user must be trained in the proper usage of the system. The saddle of the hook is designed to easily fit around pipes or framework, and the machined tip is rated for full Working Load Limit. Meets the requirement of NFPA 1983 -Light-Use Auxiliary Equipment. Designed in conjunction with FDNY Research Division.

Dimensions: 6.74" x 3.658" **Width of Opening:** 2.14 in. **Weight:** 13.6 oz.

DISCLAIMER: Firefighter escape requires instruction and training. Firefighting and associated operations are dangerous and may cause injury or death. It is every firefighters responsibility to be trained and knowledgeable on their equipment and its intended use.

2416104

Escape Hook



WINDOW RAPPEL ANCHOR

Skedco's unique anchor design allows escape from burning buildings where there are no other anchors available. This is your "Last Chance Bailout" anchor. It will fold to be carried in a holster or bailout kit. When used, the ends are extended, a carabiner is placed into the holes in both parts and the anchor is placed into the lower corner of a window and a rope is attached. It is necessary to keep tension on your rope to prevent the anchor from slipping out of position. This anchor keeps your rope farther away from the flames which gives you a little more time to descend to safety. Made in USA.

Deployed measurements: 10 5/8" x 3" x 5/8" **MBS:** 5,000 lbs **Color:** Red, Black

DISCLAIMER: Firefighter escape requires instruction and training. Firefighting and associated operations are dangerous and may cause injury or death. It is every firefighters responsibility to be trained and knowledgeable on their equipment and its intended use.

21177654
21177651

Color
Red
Black



All escape descenders should be fully tested to determine compatibility with the brand of rope used. All users of Escape descenders must be fully instructed in the use of the descenders to ensure competency in "bail-out" and "escape" operations.

EGRESS RIT RESCUE KITS WITH D2 ESCAPE DESCENDER



1. SELECT A DESCENDER

D2 ESCAPE DESCENDER

The Escape kits on this page utilize the all new D2 Escape Descender. The D2 Escape Descender is the latest in the joint development program between RescueTECH and ISC. Double Stop design for extra safety. Easily positioned on the rope. A simple push on the lever controls descent and lowering functions. No "handle squeeze" required. (more info on page 17)

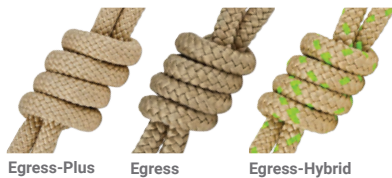

Egress-Plus Egress Egress-Hybrid

2. SELECT ROPE

PERSONAL ESCAPE ROPE (P.E.R.)

Select one of our excellent Escape Ropes. These ropes are designed for strength and durability. Choose the

- EGRESS+PLUS (100% Technora Sheath and Core) • EGRESS (Technora Sheath / Nylon Core) • EGRESS-Hybrid (Technora/Polyester sheath and Nylon core).

(more info on page 7)



3. SELECT END TERMINATION

HOOK OR SNAP

Select either the Forged Steel FDNY Crosby Escape Hook or our Forged Autolocking snap for the end termination of the Escape Rope. (more info on page 17)



D2/EGRESS+PLUS - HOOK

EGRESS+Plus™ w/ Sewn Eye & Hook

- D2 Escape Descender • Heat Resistant Pouch
- EGRESS+PLUS Rope with FDNY Hook • Extension Strap

		Length
5254011050	D2/ EGRESS+Plus™ Hook	50'
5254011070	D2/EGRESS+Plus™ Hook	70'



D2/EGRESS+PLUS - SNAP

EGRESS+Plus™ w/ Sewn Eye & Snap

- D2 Escape Descender • Heat Resistant Pouch
- EGRESS+PLUS Rope with Autolocking Snap
- Extension Strap

		Length
5254012050	D2/EGRESS+Plus™ Snap	50'
5254012070	D2/EGRESS+Plus™ Snap	70'



D2/EGRESS - HOOK

EGRESS™ w/ Sewn Eye & Hook

- D2 Escape Descender • Heat Resistant Pouch • EGRESS Rope with FDNY Hook • Extension Strap

		Length
5254111050	D2/EGRESS™ Hook	50'
5254111070	D2/EGRESS™ Hook	70'



D2/EGRESS - SNAP

EGRESS™ w/ Sewn Eye & Snap

- D2 Escape Descender • Heat Resistant Pouch • EGRESS Rope with Autolocking Snap • Extension Strap

		Length
5254112050	D2/EGRESS™ Snap	50'
5254112070	D2/EGRESS™ Snap	70'



D2/EGRESS - HYBRID - HOOK

EGRESS-Hybrid™ w/ Sewn Eye

- D2 Escape Descender • Heat Resistant Pouch • EGRESS-Hybrid Rope with FDNY Hook • Extension Strap

		Length
5254211050	D2/EGRESS-Hybrid™ Kit	50'
5254211070	D2/EGRESS-Hybrid™ Kit	70'



D2/EGRESS - HYBRID - SNAP

EGRESS-Hybrid™ w/ Sewn Eye

- D2 Escape Descender • Heat Resistant Pouch • EGRESS-Hybrid Rope with Autolocking Snap • Extension Strap

		Length
5254212050	D2/EGRESS-Hybrid™ Kit	50'
5254212070	D2/EGRESS-Hybrid™ Kit	70'

EGRESS RIT RESCUE KITS WITH RT ESCAPE DESCENDER



RT ESCAPE/EGRESS+PLUS - HOOK

EGRESS+Plus™ w/ Sewn Eye & Hook
 • RT Escape Descender • Heat Resistant Pouch • EGRESS+PLUS Rope with FDNY Hook • Autolocking Carabiner

		Length
5253011050	ESCAPE/EGRESS+Plus™ Hook	50'
5253011070	ESCAPE/EGRESS+Plus™ Hook	70'



RT ESCAPE/EGRESS+PLUS - SNAP

EGRESS+Plus™ w/ Sewn Eye & Snap
 • RT Escape Descender • Heat Resistant Pouch • EGRESS+PLUS Rope with Autolocking Snap • Autolocking Carabiner

		Length
5253012050	ESCAPE/EGRESS+Plus™ Snap	50'
5253012070	ESCAPE/EGRESS+Plus™ Snap	70'



RT ESCAPE/EGRESS - HOOK

EGRESS™ w/ Sewn Eye & Hook
 • RT Escape Descender • Heat Resistant Pouch • EGRESS Rope with FDNY Hook • Autolocking Carabiner

		Length
5253111050	ESCAPE/EGRESS™ Hook	50'
5253111070	ESCAPE/EGRESS™ Hook	70'



RT ESCAPE/EGRESS - SNAP

EGRESS™ w/ Sewn Eye & Snap
 • RT Escape Descender • Heat Resistant Pouch • EGRESS Rope with Autolocking Snap • Autolocking Carabiner

		Length
5253112050	ESCAPE/EGRESS™ Snap	50'
5253112070	ESCAPE/EGRESS™ Snap	70'



RT ESCAPE/EGRESS-HYBRID - HOOK

EGRESS-Hybrid™ w/ Sewn Eye
 • RT Escape Descender • Heat Resistant Pouch • EGRESS-Hybrid Rope with FDNY Hook • Autolocking Carabiner

		Length
5253211050	ESCAPE/EGRESS-Hybrid Hook	50'
5253211070	ESCAPE/EGRESS-Hybrid Hook	70'



RT ESCAPE/EGRESS-HYBRID - SNAP

EGRESS-Hybrid™ w/ Sewn Eye
 • RT Escape Descender • Heat Resistant Pouch • EGRESS-Hybrid Rope with Autolocking Snap • Autolocking Carabiner

		Length
5253212050	ESCAPE/EGRESS-Hybrid Snap	50'
5253212070	ESCAPE/EGRESS-Hybrid Snap	70'



1. SELECT YOUR DESCENDER

RT ESCAPE DESCENDER

The Escape kits on this page utilize our original RT Escape Descender. The RT Escape Descender is a multi-hole descending device that may be rigged to accommodate users weight. Easily positioned on the rope.
 (more info on page 17)

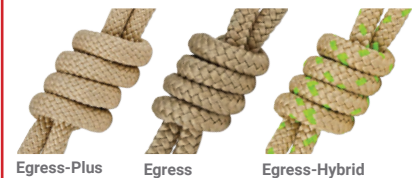

2. SELECT ROPE

PERSONAL ESCAPE ROPE (P.E.R.)

Select one of our excellent Escape Ropes. These ropes are designed for strength and durability. Choose the

• EGRESS+PLUS (100% Technora Sheath and Core) • EGRESS (Technora Sheath / Nylon Core) • EGRESS-Hybrid (Technora/Polyester sheath and Nylon core).
 (more info on page 7)



3. SELECT END TERMINATION

HOOK OR SNAP

Select either the Forged Steel FDNY Crosby Escape Hook or our Forged Autolocking snap for the end termination of the Escape Rope.
 (more info on page 17)



25', 35' & 50' Kit

70' & 100' Kit

EGRESS-N™ ESCAPE KITS

A non-aramid version of our popular EGRESS Kits. Assembled using our EGRESS-N Nylon/Polyester™ NFPA Personal Escape Rope, Nylon Escape pouch, AutoLocking Rigging Carabiners, and RescueTECH ESCAPE 8 Descender. To use, simply open outer pouch, grasp the Autolocking Rigging Carabiner, and pull from bag. The 8mm EGRESS-N™ Personal Escape Rope (NFPA) makes this PER an economical choice over the fire-resistant EGRESS™. Manufactured of Nylon and Polyester, this certified cord works well with most Escape Descenders. Custom lengths available.

Kit Includes: • EGRESS-N™ P.E.R. • Escape 8 Descender • NFPA Offset Carabiners • RescueTECH Escape Snap 1000 den Cordura Pouch
Strength: 5,000 lbf.

Warning: EGRESS-Nylon is not fire or heat-proof. Polyester begins to lose strength at 300 °F. Small diameter cords do not provide the same amount of rappelling friction as do larger ropes. Rescuers should practice rappelling with an 8mm cord to become familiar with the 8mm diameter lines. NFPA 1983 states that Personal Escape Ropes are for single use only.

		Length	Color
5253328050	EGRESS-N™	50'	White/Blue
5253328070	EGRESS-N™	70'	White/Blue
5253328100	EGRESS-N™	100'	White/Blue



HEAT RESISTANT TRUCK LANYARD

For use in high abrasion and high heat conditions. Ideal for use on Ladder and Platform trucks. The exceptional heat resistance of Dupont Brand Kevlar® will help those in high heat jobs such as welding, brazing, foundry, etc.

Length: 6 ft. **Weight:** 54.4 oz.



TRUCKMAN'S TOOL HOLSTER

Fits Most Harnesses

New design tool / axe holster for rescue harnesses. Fits onto any webbing up to 1.75 inches with heavy duty hook and loop fastener system. Adjustable webbing strap holds tool in place. Fits axes, Halligan tool, etc.



EGRESS EXTENSION SLING

A handy sling for use with Escape Belts and Harnesses. Extends escape descender allowing better handling and visualization of the descender. Made with Kevlar Brand heat Resistant webbing and thread. We utilize our Autolocking Escape Snap that is easier to open with structural gloves than twistlock-style carabiner gates. 6mm Stainless Steel Rapid Link provides a secure attachment to escape units.

Length: 16"



753786F Kevlar® Lanyard w/ Zorber & Ladder Hook

6091514 Tool Holster

609005 EGRESS Extension Sling



All escape descenders should be fully tested to determine compatibility with the brand of rope used. All users of Escape descenders must be fully instructed in the use of the descenders to ensure competency in "bail-out" and "escape" operations.



UNIFORM EMERGENCY BELT

Quick Adjust Buckle

A modified version of our Survival Belt™. Lightweight forged “V” ring is used for carabiner attachment point and is held securely by a velcro loop. Steel Adjuster Buckle insures security without slipping. Extra webbing secured with hook and loop fastener.

Tensile Strength: 5,000 lbf. Color: Black or Red Weight: 10.4 oz. (Standard)

Meets NFPA 1983 Strength requirements for Escape Belt. Meets ANSI/OSHA Class I Belt design requirements. NFPA Rating: Escape Belt.

Black	Size	Waist
703306	Standard	28" - 40"
703308	Large	40" - 55"

Red	Size	Waist
7033164	Standard	28 - 40"
7033184	Large	40 - 55"



SURVIVAL BELT™ II

A multi-purpose belt for emergency rappels, belays, restraint straps, anchor slings, tourniquets, etc., that can be worn as a uniform belt. With carabiner attached to the forged buckle, the belt allows the user to “get out quick”. New design uses high strength Adjustable Rigging Buckle. Hook and Loop neatly secures spare length. Manufactured with 1 3/4" heavy duty webbing.

Tensile Strength: 6,000 lbf. Color: Black Weight: 9.6 oz. (Medium)

Meets NFPA 1983 Strength requirements for Escape Belt. Meets ANSI/OSHA Class I Belt design requirements. NFPA Rating: Escape belt.

	Size	Waist
703521	Small	25" - 36"
703531	Medium	32" - 42"
703541	Large	36" - 48"
703551	XLarge	40" - 55"



GRAPPLE-SPEED UNIFORM BELT

A popular belt from our Tactical & Law Enforcement line, the GRAPPLE is now available for the rest of Public Safety personnel. Special Type 7 flat webbing double layered with stiffener for a solid equipment platform. You can now hand punches directly on your belt without having the webbing “roll”. Quick adjustment with hook and loop to secure “tail”. Features a COBRA quick-attach adjuster buckle. Carabiner not included.

Rating: Escape Color(s): Black, Tan, Green Weight: 20 oz (L)

	Size	Waist
356.0011.121.2xx	Small	28 - 34"
356.0011.121.3xx	Medium	34 - 42"
356.0011.121.4xx	Large	41 - 48"
356.0011.121.5xx	XLarge	48 - 55"



TURNOUT ESCAPE HARNESS

Class II Harness for Inside or Outside of the Turnout Pants

Designed to be kept with your turnout gear, this harness may be worn on the outside (Heat Resistant version) or between thermal layer and shell layer (either Heat Resistant or Nylon version). Special Clik-Lok buckle and attachment strap allows this harness to be easily donned. Waist buckle requires both triggers to be depressed before disengagement. Extended “D” ring rigging point eases attachment. Heat Resistant version manufacture with webbing and thread made from DuPont Kevlar fiber. Sizing should be determined by waist measurement while wearing turnout pants. Optional Harness Keeper Tabs fit standard suspender buttons and keep harness in place.

Weight: Nylon - 31.2 oz.; Kevlar: 32.8 oz.

	Item Description/Size	Color	Waist
7021131	Nylon, M/L	Black	28"- 44"
7021134	Nylon, M/L	Red	28"- 44"
7021151	Nylon, XLarge	Black	38"- 54"
7021154	Nylon, XLarge	Red	38"- 54"
7021161	Nylon, XXLarge	Black	40"- 68"
7021231	Heat Resistant, M/L	Black	28"- 44"
7021251	Heat Resistant, XLarge	Black	38"- 54"



TURNOUT HARNESS KEEPERS

A handy set of webbing keepers that help hold the harness in place when used either outside the bunker pants or between the thermal layer and shell. Anchors to the suspender attachment of bunker pants. 2 styles of keepers accommodate the “button-style” or “loop-style” suspender attachment systems.

7021294	Harness Keeper Tabs, Button-Style Set of 4
7021295	Harness Keeper Tabs, Loop-Style Set of 4



Clik-Lok Waist Buckle is connected before closing the pants waist buckle.



“D” Ring rigging point extends up and over waist of pants.



Harness keeper tab snaps around waist belt of harness.



Harness keeper tab attaches to suspender button underneath suspender.

FIRE RESCUE

BELTS, LANYARDS, AND HARDWARE

RescueTECH has spent many years supplying specialized belts and lanyards for a variety of Escape and "Bail-Out" uses. From original Survival Belt first manufactured in 1983 to our Turnout Escape Harness, we spend the time to select the proper webbing and hardware for each item. Our Escape Belts and Harnesses are available in both Heat Resistant Kevlar brand webbing and high strength nylon and polyester. And since these items are made in our facility in Carrollton, GA, you are assured of top quality and workmanship.



CORONA™ FR TRUCK / ESCAPE BELT WITH LADDER HOOK



Made from Kevlar Brand Heat Resistant Web

Our popular Heat Resistant Corona Escape Belt with integral Ladder Hook. Manufactured of Kevlar® Brand fibers from Dupont and forged hardware Retro-reflective striping. One-Size-Fits Most. Ladder Hook manufactured from high strength, alloy aluminum. Perfect for use in ladders and platforms.

Strength: 6,000 lbs. Hook Strength: 5,000 lbs. Weight: 53.6 oz.

Meets structural test requirements of NFPA Life Safety Escape Belt Standard. Meets ANSI/OSHA Class I Belt design requirements.

701122H	Small, 26" -32"
701132H	Standard, 34" -56"



CORONA™ FR TRUCK / ESCAPE BELT



Made from Kevlar Brand Heat Resistant Web

Belt is easily secured around waist using unique double locking snap hook and 'D' Ring adjuster. Can be used as an equipment belt for carrying axes or forcible entry tools. Two light weight D-rings slide along belt to secure escape rope system bag. Retro-reflective striping.

Strength: 6,000 lbs. Weight: 38.4 oz. Waist: 34 - 56"

Meets structural test requirements of NFPA Life Safety Escape Belt Standard. Meets ANSI/OSHA Class I Belt design requirements.

701122	Small (26 - 32")
701132	Standard (34 - 36")
701152	XL (44 - 68")



CORONA™ TRUCK / ESCAPE BELT



This Nylon Escape Belt is the perfect economical substitution for our Kevlar Belt. Belt is easily secured around waist using unique double locking snap hook and 'D' Ring adjuster. Can be used as an equipment belt for carrying axes or forcible entry tools. Two light weight D-rings slide along belt to secure escape rope system. Retro-reflective striping on Gold unit.

Strength: 6,000 lbs. Weight: 33.6 oz. Waist: 34 - 56"

Meets structural test requirements of Life Safety Escape Belt Standard. Meets ANSI/OSHA Class I Belt design requirements.

	Color
701032	Gold w/ Scotchlite®
701031	Black



HEAT-RESISTANT TRUCK / ESCAPE BELT



Unique heat resistant "belt" to meet NFPA Ladder / Escape Belt standards. Belt is easily secured around waist using unique double locking snap hook and 'D' Ring adjuster. Can be used as an equipment belt for carrying axes or forcible entry tools. Two light weight D-rings slide along belt to secure escape rope system bag.

Color: Black Weight: 28.8 oz.

Meets structural test requirements of Life Safety Escape Belt Standard. Meets ANSI/OSHA Class I Belt design requirements.

	Size	Waist
701131	Standard	34 - 56"
701131XL	XLarge	44 - 68"



All escape descenders should be fully tested to determine compatibility with the brand of rope used. All users of Escape descenders must be fully instructed in the use of the descenders to ensure competency in "bail-out" and "escape" operations.



SLING-LINK RDP-FIRE

The MAST Rapid Deployment Pouch is an excellent way to mount the MAST or carry the Tool on the Rescuer, a way to keep it clean and ready for use. Made from 1000 den cordura. Includes chrome plated swivel snap. Easy to use pull strap deploys Sling-Link. Available as Pouch only or as a kit. Kit includes RDP and MEN1-31 Sling-Link.

		Color
7082932x	RDP-Fire Pouch	Black, Yellow, Red
29982505BK	RDP-Fire Kit	Black



SLING LINK MAST

Multiple Application Service Tool fo Horizontal Drags and Vertical Lifts

Sling-Link MAST is used by some of the most advanced rescue teams and rescue instructors in the country. The MAST is designed for the fire/rescue service as a tool to be utilized in the "Save Our Own" program, Rapid Intervention Team (RIT) and FAST teams. The functions of the MAST are almost unlimited... The MAST is simple... Always available for the rigging of equipment in seconds, for rescue in moments, and always a way to get out. The MAST is a tool that should be carried in the bunker pant pocket or the specially designed pouch...and absolute must while on the fire floor. The Sling-Link MAST has the versatility of a rope with the convenience and speed of a sling. Available in multiple width webbing and strengths. Patent no. D 602 638.

	Model		Webbing	Strength (Loop-to-Loop)
708231152	MEN1-31	Standard	1" Flat	4500 lbf.
708231252	MEN1-31L	Technical	1" Flat	3655 lbf.
708261052	MEN1-61	Heavy duty	1" Flat	6000 lbf.
708291052	MEN1-91	Extra Duty	1" Flat	7500 lbf.
708292052	MEN1-92	Super Duty	2" Flat	9000 lbf.



SLING-LINK POUCH

The MAST pouch is an excellent way to mount the MAST or carry the Tool on the Rescuer, a way to keep it clean and ready for use. Manufactured with 1000 den Cordura. Sling-Link not included.

	Model		Color
7082931x	MB-31	For MEN1-31	Black, Yellow
7082961x	MB-61	For MEN1-61	Black, Yellow
7082991x	MB-91	For MEN1-91	Black



SLING-LINK RESCUE KIT-FIRE (SLRK-F)

Immediate High-Threat Extraction capability

Complete kit makes a high anchor system for emergency lowering. Multiple carry options with rapid release system. Ideal for full spectrum Hasty Rescue Options.

Includes one Sling Link™, 50' 8mm PER, low profile sewn loop eye with one fast-action ISC two-stage locking carabiner, one non-locking utility carabiner, multifunction / multi-deployment rope bag with integrated kangaroo pouch for Sling-Link MAST®.

299831150BK	Sling-Link Rescue Kit - Fire
-------------	------------------------------



Useful as:

- High anchor casualty removal system
- Bail Out (Individual /Team)
- Hasty linear 2-1 System
- Rapid stairwell casualty removal
- Confined space/low-visibility search



FIREFIGHTER LADDER RESCUE SYSTEM

Containing the RescueTECH Spin-Lock Double Pulley, this rescue set provides a free-running 3:1 Block and tackle that does double duty as a friction lowering device. The Spin-Lock Pulley works as a capstain lowering device that provides friction while lowering the firefighter. Proper safety precautions, such as separate brakes or rope grabs are to be used when in both raise and lower modes. Sling attaches around ladder beams or to suitable rigging point above victim. Packaged ready-to-use in RescueTECH Rigging Bucket.



	Height
299845075	2 Story
299845120	3 Story

FIREFIGHTERS' RIT RESCUE SLING

Multi-Use Rescue Tool

Designed to be a helping hand during fire rescue activities. Pouch is designed to fit all waist belts and to keep the sling available at all times. Simply grasp the hand loops and pull to deploy this 7 ft. sling. Contoured hand loops are easily grasped by structural firefighting gloves. Multiple uses: RIT, Search, Utility. Can be linked together to help with large area searches.

Length: 80" Weight: 9.6 oz.

29967420

Rescue Sling



RIT FR RESCUE SLING

Heat Resistant Sling and Belt Pouch

Based on the design of our Firefighters' RIT Rescue sling, the FR Sling is manufactured of Heat Resistant Webbing featuring Kevlar® brand fire resistant fibers. Easily attached Heat Resistant pouch is designed fit all waist belts and to keep the sling available at all times. Simply grasp the hand loops and pull to deploy this 7 ft. sling. Contoured hand loops are held open by an internal stiffener and is easily grasped by structural firefighting gloves. Multiple uses: RIT, Search, Utility. Can be linked together to help with large area searches.

Weight: 7.2 oz.

29967521

FR Rescue Sling



Stows in Included Pouch



FIREFIGHTERS DRAG / SEARCH SLING

Handles with Rubberized Grips

Designed to aid Firefighters and RIT Team personnel. Stored in an included pouch that will attach to SCBA waist straps or will store in Turnout Gear pockets. The sling is comprised of heavy duty 1" tubular webbing, forged steel D-Ring, non-locking aluminum carabiners, and custom handles with rubberized grips and reflective tape.

Overall Length of Red Rescue Sling: 70"

2369104

F.F. Drag/Search Sling



PPE CARRIER



Durable system that holds and transports PPE for Fire, Police and Military. Standard version complete with 2 TACLINKS to attach helmet and other equipment. Designed with 2 inch top attachment strap with sturdy handle and a 2 inch wide boot strap with a slipok and strap keeper for easy customized adjustment that tightly cinches gear for transport. Includes adjustable shoulder strap with movable rubber comfort pad and interlocking side release buckles for quick attachment and release. Configuration designed to ensure a balanced load with no stress on boot loops. System has slots for up to six carabiners to attach multiple piece of gear to belt and assembles in less than 60 seconds to provide faster deployment of your gear than conventional storage options. Open air assembly allows gear to dry quickly, preventing odor and bacteria build up; connects all primary equipment pieces (helmet, face mask, gloves) to the attachment strap to be hung in the cab as one unit, keeping gear secure and off the floor; use the attachment strap to close around rope and carry other tools.

29962011

PPE Carrier

VANGUARD G2™

FULL BODY HARNESS



NFPA Class III Rescue Technician Harness

A major update to our original VANGUARD™ harness. We reworked the dorsal D ring assembly to better distribute the load to the legs. The new waist and leg pads were redesigned for more comfort. We improved our waist pad by enhancing the Aerospace™ Mesh waist pad shape. The Aerospace™ mesh padding is hydrophobic /hydrophilic and works as a “pump” that pulls moisture away from the body and helps cool the rescuer. A polycarbonate insert spreads the forces across the full length and width of the waist pad. Additionally, we upgraded the leg pads to also include a polycarbonate insert to spread the forces and keep the pad from rolling like other harnesses. Designed for function and comfort.

Easy donning aided by 2-piece color coded leg buckles. Forged D rings at the front waist and chest provide rescuer main and belay attachments. Forged dorsal ‘D’ ring for fall protection and belay attachments. Lifting rings on shoulders allow vertical lifting out of confined spaces. Canted side ‘D’ rings provide an attachment point for positioning lanyards and stow out of the way when not in use. The Vanguard GEN2 also allows for both side entry and over the shoulder donning of the chest/shoulder section. Shoulder section attached to seat section with Delta Shaped Rapid Link. Made in U.S.A. SEI Certified to NFPA 1983. Weight: 99 oz. (Med/Lg)

VANGUARD-G2™ RESCUE



Cert. Model (NFPA 1983.2017)

	Size	Height	Waist
7304202	S	5'2" - 6'	27" - 35"
7304302	M/L	5'2" - 6'	31" - 39"
7304502	XL	5'9" - 6'8"	35" - 51"



Upgraded Waist Pad"



Cert. Model (NFPA 1983.2017)



Shoulder Pad Accessory Equipment Loops



New suspension system for greater comfort



All Vanguard G2 harnesses are compatible with the PORTER accessory hanger



RT-Vanguard-G2-Clk-Waist-side (uses quick-connect CLIK-Lok Buckles (16kN straight pull))



Cert. Model (NFPA 1983.2017)

VANGUARD-G2™ CLIK

Quick Connect Waist and Legs speeds Donning

We took our new VANGUARD GEN2 and added Clk-Lok buckles to speed donning and doffing. Aerospace™ Mesh waist pad is hydrophobic / hydrophilic and works as a “pump” that pulls moisture away from the body and helps cool the rescuer. A polycarbonate insert spreads the forces across the full length and width of the waist pad. Additionally, we upgraded the leg pads to also include a polycarbonate insert to spread the forces and keep the pad from rolling like other harnesses. Designed for function and comfort.

Easy donning aided by Clk-Lok waist and leg buckles. Clk-Lok buckles are made from alloy aluminum, stainless steel, and plated steel. High strength 16Kn straight pull strength. Forged D rings at the front waist and chest provide rescuer main and belay attachments. Forged dorsal ‘D’ ring for fall protection and belay attachments. Lifting rings on shoulders allow vertical lifting out of confined spaces. Canted side ‘D’ rings provide attachment point for positioning lanyards and stow out of the way when not in use. The VANGUARD GEN2 also allows for both side entry and over the shoulder donning of the chest/shoulder section. Shoulder section attached to seat section with Delta Shaped Rapid Link.

Made in U.S.A. SEI Certified to NFPA 1983. Weight: 108 oz. (Med/Lg)

	Size	Height	Waist
7305201	S	5'2" - 6'	27" - 35"
7305301	M/L	5'2" - 6'	31" - 39"
7305501	XL	5'9" - 6'8"	35" - 51"



PRIME

FIRE/RESCUE HARNESS

PRIME FIRE/RESCUE HARNESS

Designed to fit the needs of most rescuers. The PRIME harness features padding in the waist and legs, offering one of the most comfortable rescue harnesses around. Primary rigging points on front waist and chest. Our proprietary pads continue to offer superior force distribution and feature breathable cushioning next to the rescuer's body. The Dorsal D-Ring position can be adjusted to the height requirements of the Rescuer. Once adjusted, the D-ring is fixed at that height and does not slide up when a load is applied. The Front D-Ring is a fixed position ring that distributes the forces directly to the seat portion of the harness. The upper portion of the harness features over the shoulder or side entry donning and connects to the seat with a stainless steel rapid link. The front D-Ring assembly will accept our Harness Ascender Loop for use as a chest ascender attachment point. 2 piece Color coded adjusters on the legs make donning quick and adjustment easy. Strong rigging loops will hold needed equipment. Certified NFPA 1983 by the Safety Equipment Institute.



	Size	Height	Waist	Color
7321204	S	5'2" - 6'	27" - 35"	Red/Black
7321304	M/L	5'2" - 6'	31" - 39"	Red/Black
7321504	XL	5'9" - 6'8"	35" - 51"	Red/Black
7321201	S	5'2" - 6'	27" - 35"	Black
7321301	M/L	5'2" - 6'	31" - 39"	Black
7321501	XL	5'9" - 6'8"	35" - 51"	Black



Cert. Model (NFPA 1983.2017)



PORTER TOOL HOLDER

Plastic holder for racking industrial tools on harnesses.

- Easy clipping and un-clipping
- Rubber part holds the PORTER in place and prevents it from rotating

Color: Black; Weight: 1.1 oz. (32 gm); Material: Plastic w/ rubber keeper; Gate Opening: .9 in (23mm); Max Load: 11 lbs. (5 kg)

WARNING: NOT FOR CLIMBING! The Porter is NOT load-bearing! It is not designed to hold human's weight. Do not use it for protection or belaying.

2389119000



HARNES ASCENDER LOOP

This handy, high strength webbing loop enables attachment of a chest ascender to our VANGUARD and ADVANTAGE full body harnesses. Simply girth-hitch the sling around the top "eye" of the chest ascender then pass the loop through the chest 'D' ring slot. The loop then attaches to the carabiner or rapid link at the waist of the harness. Ascender not included.



602307

Harness Ascender Loop

ADVANTAGE-G2 CLIK RESCUE HARNESS

Our new ADVANTAGE-CLIK GEN2 harness builds upon our standard ADVANTAGE G2 harness by adding ISC CLIK-LOK buckles to ease donning of the harness. New Waist pad design that incorporates the Aerospace mesh for comfort, the pad is larger than that of the VANGUARD II and has a polycarbonate stiffener to better distribute the forces – increasing the comfort of the harness. Fully adjustable design features padded waist, legs, and shoulders. Unique shaped shoulder pad system makes the Advantage super-comfortable and has soft-attach points for vertical lifting bridles. Suitable for Work and Rescue, Fall Arrest, Work Positioning, Descent, and Ascent. Buckles make size adjustment quick and secure – no need to tie off webbing tails. Main rigging rings at front waist and chest. Fall arrest ring in dorsal position. Stowaway side waist rings for positioning. Made In U.S.A.

Weight: 92 oz. (Med/Lg)

Certified Standards: • NFPA 1983



Cert. Model (NFPA 1983.2017)

	Size	Height	Waist
7315201	Small	5'2" - 6'	27" - 35"
7315301	Medium/Large	5'2" - 6'	31" - 39"
7315501	XLarge	5'9" - 6'8"	35" - 51"



Accessory Equipment Loops on Shoulder Pads



Upgraded Waist Pad"



Stowaway Positioning Rings on Waist



WARNING

Technical rescue and safety is potentially hazardous. Any person using equipment sold by RESCUE TECHNOLOGY in any manner is personally responsible for learning the proper techniques involved, and assumes all risks and accepts full and complete responsibility for any and all damages or injury of any kind, including death, which may result from the use of any RESCUE TECHNOLOGY equipment

TECH NOTE



QUICK FIT BUCKLES

Our high strength Quick-Fit buckle allow quick adjustment to our harnesses. Manufactured from high strength steel and plated for corrosion resistance.



CLIK-LOK BUCKLES

Rated at 36 kN in straight pull (not looped), The ClIK-LOK buckle is the strongest buckle of this style. Uses the Quick-fit style adjustment system.



PRIME™ SEAT HARNESS



Cert. Model (NFPA 1983.2017)



VANGUARD™ PADDED SEAT HARNESS

NFPA Class II Rescue Harness

Our newest Class II seat harness will impress you with its versatility and comfort. Special “breathable”, laminated foam padding provides comfort not often found in basic seat harnesses. Special 2-piece buckles allow you to don without having to “step-through” the harness. Quick-adjust waist buckle. Primary rigging “D” ring floats along the waist strap to better balance the forces placed on the rescue - giving greater comfort. Side “D” rings allow for placement of positioning lanyards and fold away for storage.

SEI Certified NFPA 1983. Made In U.S.A.

PRIME SEAT HARNESS

	Size	Waist
7052021	Small	27" - 35"
7052031	Medium	31" - 39"
7052051	XLarge	35" - 51"



ADJUSTABLE TAC SEAT

The Adjustable TAC Seat build from the trusted Adjustable Seat harness design. From this design we created some improvement. Waist and leg buckles are quick-adjust for rapid sizing. Leg loops are designed for maximum comfort and will rotate slightly with leg movement. Forged D ring rigging point.

	Size	Waist
7091031	Med/Large	30" - 39"
7091041	XLarge	34" - 44"



PADDED ADJUSTABLE TAC SEAT

A padded version of the Adjustable TAC that adds a rear “D” Ring for positioning use.

	Size	Waist
7092031	M/L	30" - 39"
7092051	X/L	34" - 44"



Deluxe Version with Pouch



TAC RAPPEL HARNESS

Quick Adjust Waist Buckle

The new TAC Rappel Harness features a quick-adjust waist buckle with comfort pads. Additionally, a double thickness waist allows us to put additional gear loops on the right side. Includes storage bag. Available in standard and deluxe version. The Deluxe version utilizes 2-piece leg adjusters that allow the legs to be conveniently stored and the harness used as a belt until the leg loops are needed.

Color: Black

Meets NFPA/ASTM/ANSI/OSHA requirements for Seat Harness.

		Size	Waist
7091531	TAC Rappel	M/L	28 - 40"
7091551	TAC Rappel	XL	36 - 54"
7091631	Deluxe TAC Rappel	M/L	28 - 40"
7091651	Deluxe TAC Rappel	XL	36 - 54"



VOYAGER RESCUE HARNESS



Light weight design provides ease of use. Features quick adjust legs and waist. 5" waist pad for extra comfort. Chest harness attaches to waist with a high strength stainless steel rapid link for corrosion resistance. Quick-adjust leg buckles. No shoulder D-rings on Black version.

Weight: 101 oz. (Med.)

UL Certified to NFPA 1983 Class III Harness. Meets ANSI/OSHA Class III Full Body Harness requirements.

	Size	Color		Size	Color
718321	Small	Black	718326	Small	Blue
718331	Medium	Black	718336	Medium	Blue
718341	Large	Black	718346	Large	Blue
718351	XLarge	Black	718356	XLarge	Blue

RT INDUSTRIAL 3 'D' FULL BODY HARNESS



"D" Rings for Lifting / Fall Protection

Manufactured from color coded 1 3/4" polyester webbing for ease of donning. Forged steel hardware with quick-connect friction buckles for quick secure adjustments. One sliding "D" between the shoulder blades in back for attachment of lanyard and two shoulder lifting rings. Sized to fit over clothing. Positioning version has two rings at waist level.

Weight: 40.8 oz.

Meets all ANSI, OSHA standards and CSA construction requirements for Class III Harness.

	Size
7021334	Medium/Large
7021344	XLarge
7022334	Positioning, Medium/Large
7022344	Positioning, XLarge



TECHNICAL RESCUE II HARNESS

A tuned down super-lightweight version of the popular Voyager harness. Great for entry level technical rescue, rope access, short haul, and basic rope rescue. Features lighter waist and leg pads and no shoulder lifting rings to save weight. Rigging points at waist, chest, and back (dorsal). Rear haul/tag line attachment loop (3600 lbf.). Tailored shoulder straps. UL Classified to NFPA 1983 Meets OSHA/ANSI/CAN/CSA Class III Harness standards.

Color: Blue w/ Black pads Weight: 68 oz.

UL Certified to NFPA 1983 Class III Harness. Meets ANSI/OSHA Class III Full Body Harness requirements.

	Size
7162136	Small/Medium
7162156	Large/XLarge

ROPE DANCER™

Fall Protection Harness

Easy to don and easy to operate double buckles. Front and rear belay/rappe front attachment points. Reinforced tie-in loop. Full body harness designed specially for rope course.

Weight: 47.2 oz.

Meets all ANSI, OSHA standards and CSA construction requirements for Class III Harness.

	Size
23890502	Small
23890503	Medium/Large
23890505	XLarge



RTR HARNESS

Designed to meet the demands of the transmission line worker, structural access and the rope access professionals. Chest harness designed to incorporate a chest ascender (not included). Attachment points at waist, hips (positioning), chest (positioning), back (lumbar) and back (fall arrest). Extra large, side positioning rings (lineman style).

Weight: 6 lb. 11 oz.

Certified to NFPA 1983 standard. Certified to ANSI/OSHA and CAN/CSA full body harness standards.

	Size
204239012	Small
204239013	Medium
204239014	Large
204239015	XLarge



CLIK-LOK RESCUE CHEST HARNESS



The Clik-Lok Rescue Chest harness provides a full body chest rigging point when attached to our VANGUARD or Adjustable TAC Seat Harnesses. Clik-Lok chest closure makes donning easy. Quick-Adjust chest and shoulder straps. Includes Standard D Steel Autolocking carabiner.

7235134



STANDARD CHEST HARNESS



General Purpose Chest Harness

A basic style chest harness with "V" ring attachment points that can be connected with a carabiner or rope. The Standard Chest Harness features 2" chest strap webbing and 2" shoulder strap webbing. Fully adjustable. One Size Fits Most.

Color: Black Weight: 15.2 oz.

Exceeds NFPA construction requirements. Meets ANSI Class II Harness construction requirements.

723321

Standard Chest Harness



Harness Rigging Pouch shown on Corona™ Escape Belt

HARNESS RIGGING POUCH



A great addition to a rescuer's gear selection. The Rigging Pouch attaches to the waist belt of a rescue harness and provides quick access to often used equipment. Padded sides. Holds carabiners, slings, pulleys, etc. Easy access while "on rope". Locking Zipper prevents accidental opening. Inside features rigging loop and snap closure mesh pouch.

Dimensions: 9.5" w x 7" h x 3" d Weight: 8 oz.

Equipment not included.

800201

Harness Rigging Pouch



FRANKLIN WORK BOARD

Integrates with Most Harnesses

The Franklin Work Positioning Seat provides more comfort when hanging in the harness and is intended for use with our fall arrest or work positioning harnesses. Easy to adjust buckles. Wide sitting area gives good stability and comfortable hanging as well as standing work position. Suspension straps do not press on your thighs. Three D-rings (bearing capacity 110 lbs.) for gear.

Max. load of seat: 500 lbs. Weight: 3.4 lbs.

23898110

Franklin Work Board



HARNESS EQUIPMENT POUCH



Designed to hold the many tools required by rescue technicians. The main pocket has a special collar closure that is secured with a cord lock. The front bellows pouch can hold quickly needed equipment. An exterior gear loop and mesh pocket multiplies the uses of this high quality bag.

Dimensions: 8"H x 6.5"W x 4.5"D Weight: 9.6 oz.

Equipment not included.

800211

Color

800214

Black

800216

Red

Blue



Shoulder straps are not for vertical lifting.



RESCUETECH ADJUSTABLE SPREADER PLATE



18" Adjustment

The newest addition to our confined space harness lifting equipment is our low-profile Adjustable Spreader Plate. We combine a lightweight aluminum plate with adjustable straps. The adjustment allows the unit to not only work with confined space harnesses, but also with lifting devices such as the LSP Half Back.

Width: 15" Max Height under plate: 21" Min Height under plate: 8"

609028

RescueTECH Spreader Plate



RESCUETECH™ HARNESS LIFTING BRIDLE



Double Locking Snaps

Unit attaches to shoulder lifting rings with industrial double locking snaps.

Strength: 6,000 lbf. (26.7 kN) Overall Height: 23" (57.5 cm)
Strap Length: 11" (27.5 cm) Width: 16" (40 cm) Weight: 38.4 oz. (1.08 kg)

609025

Harness Lift Bridle



RESCUETECH™ DELUXE HARNESS LIFTING BRIDLE



with Built-In Wristlets

Unit attaches to shoulder lifting rings with aluminum double locking snaps.

Strength: 6,000 lbf. (26.7 kN) Overall Height: 23" (57.5 cm)
Strap Length: 11" (27.5 cm) Width: 16" (40 cm) Weight: 32 oz. (907 gm)

609026

Deluxe Harness Lift Bridle

TECH NOTE

NFPA HARNESS CLASSIFICATIONS CLASS II

Harness that fastens around the waist and around thighs or under buttocks and is designed for rescue with a design load of 2.67 kN (600 lbf.)

CLASS III

Harness that fastens around waist and around thighs or under buttocks, and over shoulders and is designed for rescue with a design load of 2.67 kN (600 lbf.)



LADDER HOOK EXTENSION™



The Ladder Hook Extension Strap allows the rescuer to attach to a ladder rung. The overall length of 18" provides the perfect length to give the rescuer both comfort and safety. Available with Autolocking Ladder Hook. Forged snap attaches the Ladder Hook Extension to the "D" ring of rescue harnesses.

Strength: 6,000 lbs. (26 kN) Overall Length: 18" (45 cm) Gate Opening: 1.5" (38mm) Rating: General Use. Weight: Steel: 32.8 oz. Aluminum: 25.6 oz.

A. 609012

Alum. AutoLock - Fire Resist.

B. 609011

Steel AutoLock - Fire Resist.

C. 609001

Steel AutoLock - Nylon



WRISTLET



Ergonomic Comfort Pads

Wrist harness for emergency use and for work locations where a full body harness might create a greater risk. Also excellent for situations requiring special positioning of the victim's arms in conjunction with a full body harness. Manufactured from nylon webbing. Special elastic tensioner helps keep unit secure when used as anklelet. Comes complete with 2 wristlets and lifting yoke. Wristlet Set includes Carabiner and storage pouch.

Weight: 5.6 oz.

Meets OSHA requirements.

609200

Wristlet w/ Yoke

94894101

Wristlet Set w/ Carabiner & Bag



VICTIM CHEST SLING

Attaches to Ladder / Victim Harness, turning the system into a Class III Victim Harness. Wide, padded chest strap supports victim's upper torso during vertical lifts. Quickly attaches around victim's chest. Connects with Double Locking Snap. Padded for comfort. Adjustable Chest and seat connector straps.

Weight: 32 oz.

723201

Victim Chest Sling



DELUXE VICTIM RESCUE CRADLE



Full Upper Body coverage with padded back panel for greater patient comfort and security. 7 strap support for superior strength. Forged D Tag line anchor helps rescuers control patient in vertical environment. Victim Arm Keepers maintain control of upper extremities. 4 Grab handles aid in maneuvering victim before, during, and after the vertical lift. Manufactured of 1000 den fabric with Cordura brand fibers, high strength webbing and forged steel hardware. (Manikin, Carabiner, and Tether not included.)

Weight: 96 oz. | WLL: 400 lbs

*Does not replace proper patient packaging using backboard, cervical collar, and head blocks.

A. Forged Steel Attachment Points. B. Heavy Duty Webbing. C. Rolls up for Storage. D. 4 Contoured Grab Handles help with positioning and allow the cradle to perform as a soft stretcher E. Padded Back Panel with internal polycarbonate support frame.

708353

Rescue Cradle*



Legs store in color-coded pouches and are ready to use.

VICTIM HARNESS

Clik-Lok Waist Buckle Speeds Donning



An innovative dual purpose harness, built to NFPA strength standards. Constructed of 1 3/4" high strength webbing, the Victim Harness utilizes our special Clik-Lok buckle on the waist on the legs. Leg loop straps are color-coded to aid in proper donning. Leg straps are stored in attached pouch to easily store and transport this harness. ClikLok waist buckle with pad is quick to don and insures user comfort.

Color: Black w/ color-coded leg straps. Weight: 30.1 oz.

Exceeds NFPA 1983 strength requirements for Class II Harness.

708366

Clik-Lok Buckle



MESH EVACUATION TRIANGLE

Features Adjustable Center Strap

Full body support for security and comfort. Easily installed on seated or standing persons. Grid design of webbing fully supports patient while mesh provides extra comfort as well as drainage for use in water rescues. Includes adjustable shoulder straps. Constructed of heavy duty Vinyl coated polyester mesh high strength webbing. Forged 'D' ring rigging points. High visibility contrast stripe for day or night use.

Weight: 53.6 oz. | WLL: 300 lbs

*Does not replace proper patient packaging using backboard, cervical collar, and head blocks.

708352

Mesh Evacuation Triangle*



EVACUATION TRIANGLE

with Shoulder Straps

An updated design of our original Evacuation Triangle. We have created a more compact version. Complete with shoulder straps.

Weight: 35.2 oz. WLL: 300 lbs

*Does not replace proper patient packaging using backboard, cervical collar, and head blocks.

708350

Evac Triangle w/ Straps*



TRIPLE9 OUTDOOR TRAUMA KIT

The triple9 Outdoor Trauma Kit (OTK) is a point of injury trauma kit designed to address life threatening blood loss. The OTK is built without pesky zippers or buttons which have been known to get gummed up or prove difficult to open when sandy, bloody or when the user is gloved, mildly hypothermic or under stress. We replaced the zippered/button access with mil-spec hook and loop. We used drill weave elastic to hold all the goodies inside. This allowed for ease of deployment while still insuring a confident retention of all the gear your OTK holds. Stocked with: SOFTW Tourniquet, Hemostatic Quick-Clot Combat Gauze, Z-Packed standard gauze, and 4" Control Wrap.

Dimensions: 6" x 8" x 3" | Weight: 12 oz.

	Weight
912393013RD	12 oz.



TRIPLE9 MICRO OUTDOOR TRAUMA KIT

The triple9 MOTK (Micro Outdoor Trauma Kit) is 3" x 3" x 6.5" in size. It is constructed from a proprietary laminated fabric and molded to shape. Complete kit includes MOTK case, SOFTW Tourniquet, and Quick-Clot Combat gauze. The MOTK can attach to your arm, backpack or harness strap, bike top bar, etc. It is the perfect size to fit a tourniquet and combat gauze. The treatment modalities are all battle-field proven and TCCC/TECC committee approved gear to stem/stop catastrophic blood loss.

The triple9 MOTK, when loaded, is a point of injury trauma kit designed for self-aid/buddy aid to stem/stop blood loss from a deep penetrating injury/laceration resulting in a partially or fully dissected major vein or artery. An Adventure Trauma Care trained person can stem blood loss from three injury points utilizing the Triple9 MOTK. Contents Included in "Complete Kit" only.

	Weight	
912393017BK	Complete	Black
912393017TN	Complete	Tan
912393017OD	Complete	Olive
912393016BK	Case Only	Black
912393016TN	Case Only	Tan
912393016OD	Case Only	Olive



BABY RESCUE BAG

Designed for rescue transporting children (height of 16" – 44" (40-110 cm) and maximum weight of 55 lbs (25 kg). Padded flaps with Velcro closure comfortably holds the victim while crossed safety straps with fast buckle securely holds everything in place. Inner padding is removable and washable. Top mesh cover opens with full zipper to provide ventilation. An outer cover with a clear window can be zipped into place if needed. Color coded rigging loops and a special stabilization strap on the top cover allows the Rescue Bag to maintain its attitude during transport. Retro-reflective stripes in the exterior webbing aids in visual identification at night. Hygienic inner blanket included.

Specifications: Color: Red; Weight: 116.4 oz (3300 g); Size: 32" x 18" x 14" (80 x 45 x 35 cm); Material: PVC Shell; Max Load: 55 lbs (25 kg)

2389238220



LAIKA DOG HARNESS

Intended for transport of the dog from a helicopter or other high angle environments. Universal size. Aluminum-alloy adjusters.

Color: Orange Capacity: 300 lbs Weight: 24.8 oz.

23898115

Laika Dog Harness

HARDWARE BY RESCUETECH



NO-SNAG GATE

Starting with our 2010 model RD70™ carabiners, RescueTECH will begin to integrate a no-snag, KeyLock gate/frame design into our rescue carabiners. This special design virtually eliminates the gate from snagging webbing or cordage.

SIDE SWING GATE

We helped design the original Angle Gate design with the Rescue D carabiner (1985). This design maximizes gate clearance creating extra room for use of the carabiner with gloves. The angle gate create almost a full 1.5 inches of carabiner opening space. Our RD70 is the first to combine the No-Snag gate with the side swing design – another first for RescueTECH.

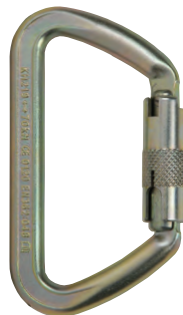

RESCUETECH BIG DAN™

Designed to Prevent Cross-Loading

Combines all the ideal design ideas into one carabiner. The Big Dan's unique frame is design to prevent cross-loading the carabiner. Cross-loads are quickly realigned to the major axis. The curved back modified 'D' design optimizes the strength and handling characteristics. Available in Twistlock (2-stage) and Supersafe (3 stage) safety mechanisms.

Strength: 11,241 lbf. (50 kN) WLL: 1,124 lbs. (511 kg) Gate Opening: 1.0" (25mm) Dimensions: 5.25 x 3.5" (133 x 89mm) Weight: 11.2 oz. (278gm) Rating: General Use

NFPA 1983, ANSI/OSHA compliant.

6051179T	Big Dan, Twistlock
6051179S	Big Dan, Supersafe (Gold)



RESCUETECH RD70™ MULTI-STAGE LOCKING GATE

Autolocking Rescue Carabiners

The newest version of our popular RD70 Rescue Carabiner. Featuring either the 2-stage Twistlock or 3-Stage Supersafe gate design. Features No-Snag, KeyLock gate design.

Strength: Gold/Black: 15,737 lbf (70 kN) WLL: 1,574 lbs. (715 kg) Gate Opening: 1.4" (35mm) Dimensions: 4.9 x 2.9" (125 x 73mm) Weight: 10.4 oz. (360 gm) Rating: General Use NFPA 1983, ANSI/OSHA compliant

60511830	Twistlock	Color
60511840	Supersafe	Gold



RESCUETECH RD70™ RESCUE CARABINER

Featuring No-Snag, KeyLock Gate Design

Rescue Tech's newest general use carabiner. Design to meet the tough-use conditions met by Rescue Technicians. Heat-treated alloy steel construction with Gold Chromate corrosion protection.

Strength: Gold/Black: 15,737 lbf (70 kN) WLL: 1,574 lbs. (715 kg) Gate Opening: 1.4" (35mm) Dimensions: 4.9 x 2.9" (125 x 73mm) Weight: 9.5 oz. (360 gm) Rating: General Use

NFPA 1983, ANSI/OSHA compliant

60511820	Screwgate	Color
60511821	Screwgate	Gold
		Black



RESCUETECH OD50™ RESCUE CARABINER

A Great Multi-Use Carabiner now with KeyLock Gate

Heat-treated alloy steel construction with Gold Chromate corrosion protection. Made to meet the toughest rescue needs.

Strength: 11,241 lbf. (50 kN) WLL: 1,124 lbs. (511 kg) Gate Opening: .8" (20mm) Dimensions: 4.4 x 2.7" (111 x 68mm) Weight: 8.8 oz. (220gm) Rating: General Use

NFPA 1983, ANSI/OSHA compliant

A. 60511750	Screwgate	Color
B. 60511730	Twistlock	Gold
C. 60511731	Twistlock	Black
D. 60511760	Screwgate w/ bar	Gold
60511740	Twistlock w/ bar	Gold
60511751	Screwgate	Black





RESCUETECH™ EXTRA-LARGE RESCUE 'D'  

Extra Large 1.5" Gate Opening
 A new design in rescue carabiners. Extra-large gate and interior dimensions let this carabiner's gate close over any round structure that will fit through the gate. 1/2" alloy steel plated with Gold Chromate. Gate locking design.

Strength: 12,589 lbf. (56 kN) WLL: 1,259 lbs. (572 kg)
Gate Opening: 1.5" (38mm) Dimensions: 6 x 3.75"
(152 x 94mm) Weight: 12.8 oz. (363gm) NFPA
Rating: General Use

UL Certified NFPA 1983. Meets ANSI/OSHA strength requirements.

6050159 XL Rescue D



HMS STEEL CARABINER

HMS design for use with munter hitches. Forged frame for high strength and long wear. KeyLock gate reduces snagging.

Gate: 15/16" Weight: 10oz. Strength: 11,240lbf

20141121220	Screwgate
20141121230	Twistlock
20141121240	Supersafe



RESCUETECH STEEL OVAL CARABINER

Improved forged design with KeyLock to reduce snagging. This sleek new look is Zinc Plated.

Gate Opening: 5/8" (17mm) | Strength: 5,620 lbf. (25 kN) | Weight: 6.0 oz. (170 gm)

Certified BS EN 362.



201431120 Screwgate
 201431130 Twistlock



KLETTERSTEIG STEEL

Gate: 1.0" | Strength: 10,000 lbf. | WLL: 1,000 lbs. | Weight: 8.8 oz.



		Dimensions
A. 6053170	Twistlock	4.9" x 3.15"
B. 6053172	Screwgate	4.9" x 3.15"
6053171	Supersafe	4.7" x 3.15"



ISC OFFSET OVAL

The Offset Oval combines the specification of an Oval with that of a 'D' shape carabiner. True Ovals are not capable of achieving high breaking loads, as their symmetrical shape shares the load between the spine and the gate of the carabiner. The Offset Oval has a slight 'D' shape that gives the highest Oval Carabiner strength. Cold Forged with KeyLock style gate.

Gate: .625" (17 mm) | Strength: 8,992 lbf. (40 kN) | Weight: 6.8 oz.



201432120	Screwgate
201432130	Twistlock



AD40 NFPA ALUMINUM CARABINER

The newest aluminum carabiner from RescueTECH and ISC. A lightweight, high strength General Use aluminum carabiner for teams and individuals. Forged Aluminum Frame provides high strength. Keylok gate designed to prevent snagging on webbing and cords. Stainless steel pins and springs increase durability. Available in Screwgate, Twistlock (2-stage), and Supersafe (3-stage) gate configurations.

Compliance to NFPA 1983 – General Use, EN362 Strength: 8,992 lbf (40 kN)

60528220	Screwgate	Grey w/ Black Gate
60528221	Screwgate	Black w/ Black Gate
60528230	Twistlock	Grey w/ Gold Gate
60528231	Twistlock	Black w/ Black Gate
60528240	SuperSafe	Grey w/ Red Gate



ISC ALUMINUM CARABINERS

ISC manufactures an extensive line of superior quality aluminum carabiners. All carabiners conform to EN and ANSI standards and meet NFPA Light Use strength requirements. The unique shape of the ISC carabiners are designed to limit cross-loading. Since the sides of the minor axis are not parallel, cross loading causes the rigging point to slide to the ends resulting in transferring the load to the major axis. Available in Screwgate, Twistlock, Supersafe and ISC's exclusive Quadlock. Gates are color-coded to identify locking style.

			Dimension	Gate	Strength	WLL**	Weight
A.	201420420	HMS, Screwgate	4.9" x 3.0"	.88"	6,745 lbf.	675 lbs.	3.5 oz.
	201420430	HMS, Twistlock	4.9" x 3.0"	.88"	6,745 lbf.	675 lbs.	3.5 oz.
	201420440	HMS, Supersafe	4.9" x 3.0"	.88"	6,745 lbf.	675 lbs.	3.5 oz.
	201420450	HMS, Quadlock	4.9" x 3.0"	.88"	6,745 lbf.	675 lbs.	3.5 oz.
B.	201445120	Mongoose, Screwgate	5.2" x 3.6"	1"	6,745 lbf.	675 lbs.	4.2 oz.
	201445130	Mongoose, Twistlock	5.2" x 3.6"	1"	6,745 lbf.	675 lbs.	4.2 oz.
	201445140	Mongoose, Supersafe	5.2" x 3.6"	1"	6,745 lbf.	675 lbs.	4.2 oz.
	201445150	Mongoose, Quadlock	5.2" x 3.6"	1"	6,745 lbf.	675 lbs.	4.2 oz.
C.	201445220	Gecko, Screwgate	4.7" x 2.9"	0.9"	6,745 lbf.	675 lbs.	3.0 oz.
	201445230	Gecko, Twistlock	4.7" x 2.9"	0.9"	6,745 lbf.	675 lbs.	3.0 oz.
	201445240	Gecko, Supersafe	4.7" x 2.9"	0.9"	6,745 lbf.	675 lbs.	3.0 oz.
	201445250	Gecko, Quadlock	4.7" x 2.9"	0.9"	6,745 lbf.	675 lbs.	3.0 oz.



OFFSET D ALUMINUM WITH CAPTIVE EYE

Features KeyLock Style Gate

Similar in shape and closure to our OD50 Offset D Steel Carabiner. The addition of the field-installable pin helps keep ropes and cords situation at the base of the carabiner. No longer can your search line come off the carabiner by simply sliding out the gate opening. Available in Screwgate and Twistlock.

Strength: 6,745 lbf. (30 kN) WLL: 675 lbs. (307 kg) Gate Opening: .827" (21mm) Dimensions: 4.5 x 2.75" (113 x 69mm) Weight: 3.25 oz. (92gm) Rating: Technical Use

Meets NFPA 1983/ANSI/OSHA strength requirements.

201421621	Screwgate	Black
201421631	Twistlock	Black



LUKE OVAL ALUMINUM

New 'H' Frame design

Creating a strong oval carabiner is a tough project. Since oval shaped carabiners equalize the load, half to the back and half to the gate, finding the right mix of materials and design is difficult. This is why you will not see a "true" oval with a strength over 5620 lbf (25 kN). Manufactured of forged alloy aluminum, the LUKE has our no-snag KeyLock gate and is available with screwgate and autolocking (2-stage) gate options.

Gate Opening: .8" (20mm) Strength: 5620 lbf. (25 kN) Weight: 3 oz. (85 gm)

201441120	Screwgate
201441130	Twistlock
201441140	Supersafe



G-FIRST NFPA ALUMINUM SCREWGATE

UL Certified NFPA-G with KeyLock Gate

The first NFPA Aluminum General Use carabiner from Omega Pacific. Their engineers took the time to create this carabiner from the highest quality allow aluminum and heat-treated it to provide the strength needed to meet NFPA General Use strength requirements. Lightweight and strong. Available in 3 color combinations.

Strength: 8,993 lbf. (40 kN) WLL: 899 lbs. (408 kg) Gate Opening: 1.2" (30mm) Dimensions: 5.1 x 3" (128 x 75mm) Weight: 4.6 oz. (140gm) NFPA Rating: General Use

	Color
60512914	Red/Silver
60512910	Silver
60512911	Black



NFPA ALUMINUM CARABINERS

Rescue Technology aluminum carabiners are designed with quality and utility in mind. Manufactured from high quality alloy aluminum, the sides of the standard size are flattened to give superior performance. Each carabiner is marked with its original strength and manufacturing batch.

Rating: Technical Use

Certified by Underwriters Laboratories to NFPA 1983.



		Color	Gate	Dimensions	Major Axis	Open	WLL
A. 6051250*	NFPA 'D' Screwgate	Silver	.625"	4.1" x 2.1"	6,070 lbf.	2020 lbf.	607 lbs.
B. 6051251*	NFPA 'D' Screwgate	Black	.625"	4.1" x 2.1"	6,070 lbf.	2020 lbf.	607 lbs.
C. 6050270	NFPA Offset 'D' Screwgate	Silver	.787"	4.5" x 2.75"	6,745 lbf.	2020 lbf.	675 lbs.
D. 6050271	NFPA Offset 'D' Screwgate	Black	.787"	4.5" x 2.75"	6,745 lbf.	2020 lbf.	675 lbs.
6050272	NFPA Offset 'D' Autolock	Silver	.787"	4.5" x 2.75"	6,745 lbf.	2020 lbf.	675 lbs.
6050278	NFPA Offset 'D' Locksafe	Silver	.787"	4.5" x 2.75"	6,745 lbf.	2020 lbf.	675 lbs.



ISO COLD FORGED CARABINERS

		Color	Gate	Dimensions	Major Axis	Open	WLL
A. 6050200	11 mm Oval Non-Locking	Silver	.625"	4.2" x 2.3"	4,946 lbf.	1350 lbf.	494 lbs.
B. 6050201	11 mm Oval Non-Locking	Black	.625"	4.2" x 2.3"	4,946 lbf.	1350 lbf.	494 lbs.
C. 6050210	'D' Non-Locking	Silver	.787"	4.3" x 2.4"	6,969 lbf.	2020 lbf.	697 lbs.
D. 6050211	'D' Non-Locking	Black	.787"	4.3" x 2.4"	6,969 lbf.	2020 lbf.	697 lbs.
E. 6050250	'D' Screwgate	Silver	.67"	4.3" x 2.4"	6,969 lbf.	2020 lbf.	697 lbs.
F. 6050251	'D' Screwgate	Black	.67"	4.3" x 2.4"	6,969 lbf.	2020 lbf.	697 lbs.

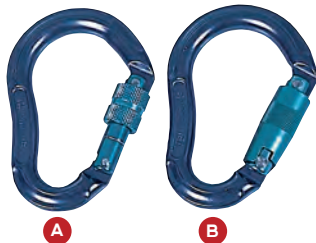

ALUMINUM CARABINERS

Larger versions of our NFPA Aluminum carabiners provide a larger gate opening. The Jake is a traditional HMS style carabiner for those who need a large, smooth radius at one end.

Rating: Light Use.

		Color	Gate	Dimensions	Major Axis	Open	WLL
A. 6050279	Jake HMS Screwgate	Gray	1"	4.6" x 3.15"	5,171 lbf.	1800 lbf.	517 lbs.
B. 6050274	Jake HMS Autolock	Gray	.94"	4.6" x 3.15"	5,171 lbf.	1800 lbf.	517 lbs.
B. 6050259	Jake HMS Locksafe	Gray	.86"	4.6" x 3.15"	5,171 lbf.	1800 lbf.	517 lbs.

TECHNOTE

ALUMINUM CARABINER GATE CONFIGURATION

The ISC Aluminum Carabiners have color-coded gate barrels for ease of identification. With the exception of the tactical versions, the gate marking is consistent through the HMS, Mongoose, and Gecko Lines.

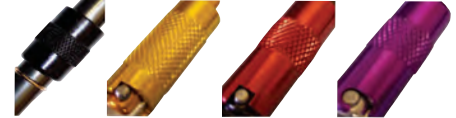

Screwgate Twistlock Supersafe Quadlock

UNITS OF MEASUREMENT

Pounds and kilograms are units of weight measurement (i.e. mass under the influence of gravity). Foot Pounds & kiloNewtons are the correct measurement of the force it takes to break an object. The conversion formula is pounds force(lbf.) = kiloNewtons (kN) divided by .004448.

ANSI REGULATIONS

ANSI fall protection regulations state that "locking type snap hooks shall have a self-closing, self-locking keeper." This statement is normally interpreted as meaning only auto-locking carabiners (snap-hooks) meet the standard.

TWISTLOCK VS. SUPERSAFE™

Supersafe gates are triple-action twistlock construction that requires three distinct movements to unlock the carabiner gate.

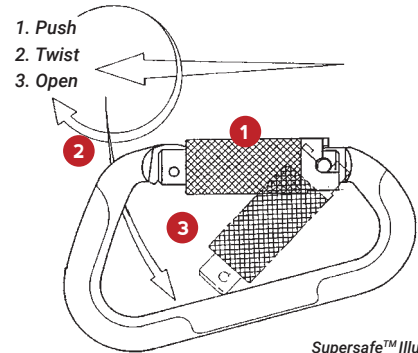

Supersafe™ Illustration

Twistlock gates are the fastest gate locking mechanism to operate. It provides a convenient solution to eliminating the chance that the gate will accidentally be left unlocked.

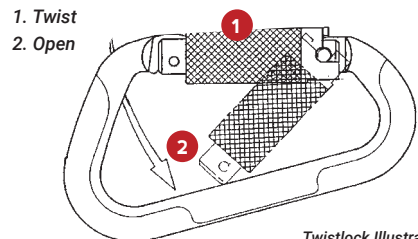

Twistlock Illustration



CE

IRON WIZARD LADDER HOOK

Mid-Sized Rescue Ladder Hook

New Ladder Hook for use where space is limited. Ideal for use in confined spaces to reduce overhead length of rigging systems.

Strength: 15,737 lbf. (70 kN) Dimensions: 7 x 4" (125 x 73mm) Weight: 19.2 oz. (289gm) Rating: General Use
NFPA 1983, ANSI/OSHA compliant

6051186

Iron Wizard



CE

ISC RIT RECOVERY HOOK

For Turnout Rescue Loop Attachment

Strong, yet lightweight, alloy aluminum locking hooks easily attach to NFPA Drag Loops. Webbing and rope slings can be attached to the rigging eye. Locking mechanism is easy to use while wearing structural gloves.

Strength: 7,869 lbf. (35 kN) WLL: 1,618 lbs. (735kg) Throat Opening: 2.326" (58mm) Weight: 17 oz. (482 gm) Dimensions: 9.5 x 5" (125 x 73mm) Rating: General Use
NFPA 1983, ANSI/OSHA compliant

20149994

Recovery Hook



CE

TRIPLE ACTION SNAP HOOK

Our new Triple Action Snaphook requires 3 separate actions to open the gate. It retains the same strength and specifications of our standard Autolocking Snaphook. The standard Autolocking Aluminum Snap Hook was selected by RescueTECH for use in our EGRESS Escape Kits and PROBE Searchline kits because of its ease of use and dependability. Manufactured of forged aluminum.

Strength: 6,070 lbf. (27 kN) Weight: 4 oz. (108 gm) Dimensions: 5.5" x 2.75" (137.5 x 68.8mm) Gate Opening: .88" (22 mm)

20149034

Triple Action Snap Hook



AUTOLOCKING SNAP WITH FORGED EYE

CE

		Dimension	Gate	Strength	WLL **	Wgt
6053198	Twistlock	5.3" x 2.9"	0.75"	11,000 lbf.	1,100 lbs.	9.6 oz.
6053197	Supersafe	5.3" x 2.9"	0.75"	11,000 lbf.	1,100 lbs.	9.6 oz.

NFPA 1983, ANSI/OSHA/BIS/DIN/EN compliant

**WLL - Recommended Working Load (also known as Safe Working Load) is calculated using the Industrial 10:1 critical use Safe Working Load Ratio.

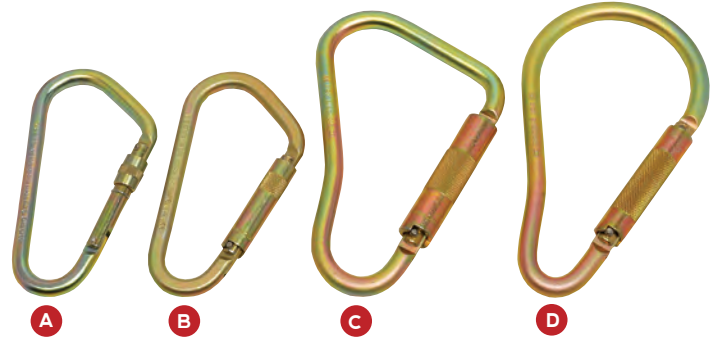

CE

SCAFFOLD HOOKS

		Dimension	Gate	Strength	WLL **	Weight
A.	201430720	Fireman Side Swing, Screwgate	7" x 3.7"	2.3"	8,993 lbf.	899 lbs. 12.8 oz.
B.	201430730	Fireman Side Swing, Twistlock	7" x 3.7"	2.3"	8,993 lbf.	899 lbs. 14.4 oz.
C.	6053180	Offset Scaffold Hook, Twistlock	8.6" x 5.5"	2.3"	10,100 lbf.	1,010 lbs. 28.8 oz.
D.	6053184	Pear Scaffold Hook, Twistlock	8.6 x 5"	2.1"	7,800 lbf.	780 lbs. 27.5 oz.

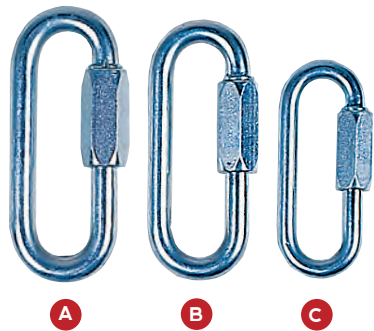

RAPID LINKS

These links are often an inexpensive alternative to standard carabiners. They are most effective in applications for semi-permanent attachments. The Delta shape link is used where multi-directional loading is encountered. All the links are complete with a long threaded nut closure. Made in France.

CE



G

		Dimension	Gate	Strength	WLL**	Rating
A.	60510112	12mm Widgate	4.85 x 2"	15/16"	13,780 lbf.	1,378 lbs. General
B.	60510110	10mm Widegate	4.13 x 1.75"	13/16"	11,020 lbf.	1,100 lbs. General
C.	60510108	8mm Widegate	3.4 x 1.45"	11/16"	7,165 lbf.	700 lbs. Technical
D.	60510214	14mm Delta	4.75 x 3.3"	5/8"	19,840 lbf.	1,984 lbs. General
E.	60510212	12mm Delta	4.1 x 2.9"	19/32"	12,125 lbf.	1,213 lbs. General
F.	60510210	10mm Delta	3.4 x 2.6"	7/16"	9,920 lbf.	990 lbs. General
G.	60510310	10mm Semi -Circle	3.4 x 2.7"	5/16"	9,920 lbf.	990 lbs. General
Stainless Steel						
F.	60511212	12 mm Delta	4.1 x 2.9"	19/32	19,290 lbf.	1,920 lbs. General

ANSI COMPLIANT CARABINERS BY ISC

The new version of ANSI Z359.1 introduced a major change to the requirements for connectors. The new edition of the standard require the gates to be tested to 3600 lbf (17kn). All three gate directions gate face load, side load, and minor axis load are tested.

Meets NFPA 1983/ANSI/OSHA strength requirements.

		Gate	Dimensions	Strength	WLL
A. 201420030	Offset D ANSI, Twistlock	.8 in.	4.25 x 2.5"	11,241 lbf.	1124 lbs.
B. 201420230	Klettersteig ANSI Twistlock	1.0 in.	4.9 x 3.2"	10,000 lbf.	1,000 lbs.
C. 201445530	Big Dan ANSI, Twistlock	1.0 in.	4.8 x 3.5"	11,241 lbf.	1,124 lbs.
D. 60528330	AD70-ANSI, Twistlock	1.0 in.	4.9 x 3.2"	8,992 lbf	900 lbs.



KLETTERSTEIG STAINLESS STEEL

The Klettersteig Stainless Steel offers the same design as our standard Klettersteig but is made from corrosion resistant stainless steel. The Klettersteig's offset design provides a larger gate opening than standard carabiners making it easier to clip over webbing.

Weight: 9.5 oz. | Gate: .875" (22 mm) | Strength: 7,868 lbf. (35 kN)

ISC FIREMAN - STAINLESS STEEL

The ISC Fireman Stainless Steel is an extra-large hook with an extra-large side swing gate.

A. 2014202230	Twistlock
B. 2014202240	Supersafe

		Weight	Gate	Strength
A. 2014307130	Twistlock	14.1 oz.	1.875" 48mm	8,992 lbf. 40kN



RD70 STAINLESS STEEL RESCUE CARABINER

Rescue Tech's newest general use carabiner. Design to meet the tough-use conditions met by Rescue Technicians. Heat-treated alloy steel construction with Gold Chromate corrosion protection.

Strength: Stainless Steel: 11,241 lbf (50 kN) WLL: 1,124 lbs. (511 kg) Gate Opening: 1.4" (35mm) Dimensions: 4.9 x 2.9" (125 x 73mm) Weight: 9.5 oz. (360 gm) Rating: General Use

NFPA 1983, ANSI/OSHA compliant

		Color
60511850	Screwgate	Stainless Steel
60511860	Twistlock	Stainless Steel

STAINLESS STEEL OFFSET 'D'

Proof Tested

Stainless Steel provides excellent corrosion resistance.

Strength: 7,870 lbf. (35 kN) WLL: 787 lbs. (358 kg) Gate Opening: .8" (20mm) Dimensions: 4.5 x 2.5" (118 x 64mm) Weight: 8.8 oz. (220gm) Rating: General Use

NFPA 1983, ANSI/OSHA compliant



6053120	Twistlock
6053121	Supersafe
6053123	Screwgate



ISC TWISTER STAINLESS STEEL

ISC performance-built carabiner are forged for best quality. The Twister features a unique "Blind Nose", which improves performance by reducing snagging. The gate barrels are designed with a square cut notch to limit debris build up.

		Gate Opening	Strength	Weight
A. 2014250230	Twistlock	.75"	5,171 lbs. 23kN	12 oz. 341 gm
B. 2014250240	Supersafe	.75"	5,171 lbs. 23kN	12 oz. 341 gm



FORGED STEEL SWIVEL SNAPS

		Dimension	Gate	Strength	WLL **	Wgt
201426021	Swivel Eye Screwgate + Fall Indicator	6.4" x 3"	.75"	8,992 lbf.	900 lbs.	12 oz.
201426030	Swivel Eye Twistlock	6.4" x 3"	.75"	8,992 lbf.	900 lbs.	12 oz.
201426031	Swivel Eye Twistlock + Fall Indicator	6.4" x 3"	.75"	8,992 lbf.	900 lbs.	12 oz.
201426040	Swivel Eye Supersafe	6.4" x 3"	.75"	8,992 lbf.	900 lbs.	12 oz.
201426041	Swivel Eye Supersafe + Fall Indicator	6.4" x 3"	.75"	8,992 lbf.	900 lbs.	12 oz.

Snaps are to be used in accordance with current ANSI / OSHA Fall Protection Standards.

NFPA 1983, ANSI/OSHA/BIS/DIN/EN compliant
 **WLL - Recommended Working Load (also known as Safe Working Load) is calculated using the Industrial 10:1 critical use Safe Working Load Ratio.



TWISTER ALUMINUM SWIVEL CARABINER

An all-aluminum frame swivel for lanyards and lifelines. Manufactured from forged aluminum, the Twister has an MBS of 5,500 lbf (25kN). Available in 2-stage Twistlock and 3-stage Supersafe gate closures.

Gate Opening: 5/8" (16mm) Rating: Technical Use

201425530	Twistlock
201425540	Supersafe



SWIVEL SNAP HOOK

The Swivel Snap Hook is the next generation of our popular Autolocking Snap Hook. The standard Auto-locking Aluminum Snap Hook was selected by RescueTECH for use in our EGRESS Escape kits and Probe Searchline kits because of its ease of use and dependability. The swivel model takes the twist out of lifelines. It features a Safety Heel to reduce the risk of accidental opening and a 'Blind' nose design, to reduce rope snagging. Manufactured of forged aluminum, the auto-locking gate is easy to open with structural firefighting gloves.

Meets CE EN 362

Eye Diameter: .827" (21mm) Min Breaking Strength: 6,070 lbf. (27 kN) Weight: 7.13 oz. (202gm) Gate Opening: .91" (23mm) Dimensions: 4.5" x 2" (112.5 x 50mm)

20149040 Swivel Snap Hook



RIGGING SWIVELS

Bearings Provide a Low Friction Rigging Tool

A handy tool for use where ropes or rigging must be free to rotate. Great for use in confined space rescues. Stainless Steel is stronger and more durable than comparable sized aluminum swivels.

*Certified NFPA 1983-G

**Meets NFPA 1983 Strength Specifications

		Lgt.	Strength	WLL**	Opening Diam.	Wgt.
A. 606468**	Stainless Steel	4.45"	10,000 lbf.	1,000 lbs.	3/4"	9.6 oz.
B. 606501**	CMI Axis™ Swivel	4.35"	9,000 lbf.	900 lbs.	1.25"	5.6 ox.
C. 2354159*	Petzl Aluminum, Large	4.2"	8,093 lbf.	800 lbs.	3/4"	6.4 oz.
D. 2354158	Petzl Aluminum, Small	3.3"	5,000 lbf.	500 lbs.	1/2"	4.0 oz.



QUICK RELEASE SNAP

with Swivel

Quick release under tension. Used where a line might have to be separated quickly from anchor during helicopter lifts, etc. NOT designed for continuous heavy duty use. Full size stainless steel construction.

Strength: 10,500 lbf. (46.7 kN) WLL: 1,050 lbs (477 kg) Bail Diameter: 5/8" (16mm) Dimensions: 4.4 x 2" (110 x 50mm) Rating: General Use

606302

Heavy Duty Quick Release

RESCUETECH PULLEYS



SINGLE & DOUBLE

RT PULLEY DESIGN

Rescue Technology's technical rescue pulleys are built to last. Many of our pulleys are designed without the double bend sideplates found on most pulleys and replaces them with a continuous radius bend. This bend prevents the "un-springing" of the sideplates found in traditional double bend sideplates. The Rescue Technology pulleys also feature weight reducing holes in the sideplates. Most of our pulleys also will accommodate ropes up to 5/8" (16mm). This capacity means that one pulley will handle all of today's NFPA General and Technical Use ropes.

BEARING VS. BUSHING

In rescue loads, the friction difference between bushings and bearings is minimal. It is only with loads that are greater than 5,000 lbf. that you begin to see the difference in friction. Ball bearings can dent the bearing race (brinelling). Sealed bearings can become contaminated with grit and seize. Oil Impregnated bronze bushings are stronger because there is a constant interface between the shaft, bushing, and pulley sheave. The bronze bushing is made from a soft material that will conform to the contaminant.

PULLEY SPECIFICATIONS:

	Dimension	Tread Dia.	Strength	WLL	Weight	Max. Rope Dia.
2" Single	4" x 2.75"	1.6"	8,993 lbf.	899 lbs.	8 oz.	1/2"
2.5" Single	5.1" x 3.45"	2.1"	11,240 lbf.	1124 lbs.	11.2 oz.	1/2"
3" Single	6.25" x 4.15"	2.5"	15,737 lbf.	1574 lbs.	16 oz.	5/8"
2" Double	5" x 2.75" x 2"	1.6"	8,993 lbf.	899 lbs.	13.6 oz.	1/2"
2.5" Double	6.25" x 3.45" x 2"	2.1"	11,240 lbf.	1124 lbs.	19.2 oz.	1/2"
3" Double	7.5" x 4.15" x 2.25"	2.5"	15,737 lbf.	1574 lbs.	28 oz.	5/8"



RESCUETECH NFPA 2" SINGLE

For Ropes Up to 1/2" Diameter

A pulley that works well for all rescue and work needs. A compact, NFPA General Use 2" pulley that will fit almost all rescue needs. Available in red or black. Meets NFPA 1983/ANSI/OSHA strength specifications.

RESCUETECH NFPA 2.5" SINGLE

For Ropes Up to 1/2" Diameter

A new high-strength, long wearing design. Sideplate bend to the 3 carabiner rigging point reduces flexing and stresses put on bends during high load. 3/16" sideplates are designed to protect the rope as it travels through the pulley. 2.5" diameter sheaves are design for smooth running efficiency.

Meets NFPA 1983/ANSI/OSHA strength specifications.

RESCUETECH NFPA 3" SINGLE

For Ropes Up to 5/8" Diameter

The newest addition to our pulley line that will accept ropes up to 5/8" diameter. Built to the same precision standards and quality of our other pulleys, The NFPA Single, Large is the big daddy of our aluminum rescue Pulleys.

2" Pulley		Color
61082104	Single Bushing	Red
61082101	Single Bushing	Black
61082114	Single Bearing	Red
61082111	Single Bearing	Black
2.5" Pulley		
61083104	Single Bushing	Red
61083101	Single Bushing	Black
61083114	Single Bearing	Red
61083111	Single Bearing	Black
3" Pulley		
61084104	Single Bushing	Red
61084101	Single Bushing	Black
61084114	Single Bearing	Red
61084111	Single Bearing	Black



RESCUETECH NFPA 2" DOUBLE

Compact 2" Double Pulley Design

Designed for ropes up to 1/2" Diameter. Lightweight and strong. Great for Technical rescues including tower and water rescue. NFPA General Use. Available in red or black.

Meets NFPA 1983/ANSI/OSHA strength specifications.

RESCUETECH NFPA 2.5" DOUBLE

Small Sized, Heavy Duty Design

Designed for ropes up to 1/2" Diameter. High strength and lightweight makes this the ideal multi-use pulley for rescue. NFPA General Use. Available in red or black.

Meets NFPA 1983/ANSI/OSHA strength specifications.

RESCUETECH NFPA 3" DOUBLE

High Efficiency Double Pulley

Designed for ropes up to 5/8" Diameter. Larger sheave diameter increases efficiency of hauling systems. Available in red or black.

Meets NFPA 1983/ANSI/OSHA strength specifications.

2" Pulley		Color
61082204	Double Bushing	Red
61082201	Double Bushing	Black
61082214	Double Bearing	Red
61082211	Double Bearing	Black
2.5" Pulley		
61083204	Double Bushing	Red
61083201	Double Bushing	Black
61083214	Double Bearing	Red
61083211	Double Bearing	Black
3" Pulley		
61084204	Double Bushing	Red
61084201	Double Bushing	Black
61084214	Double Bearing	Red
61084211	Double Bearing	Black





2.5" PMP*2 SINGLE PULLEY

Strength: 11,240 lbf. (50 kN) WLL: 1124 lbs. (510 kg)
 Dimensions: 6.6" x 4.6" (168 x 117mm) Weight: 14 oz. (400 gm) Rating: General Use
 Meets NFPA 1983/ANSI/OSHA strength specifications.



61063106 2.5" PMP*2 Single, Bushing (Blue)



2.5" DOUBLE PRUSIK MINDING PULLEY

Strength: 10,000 lbf. (46.7kN) WLL: 1,000 lbs. (477kg)
 Dimensions: 7.5" x 4.6" (187.5 x 117mm) Weight: 23.2 oz. (681gm) Rating: General Use
 Meets NFPA 1983/ANSI/OSHA strength specifications.



61063204 2.5" Double, Bushing



RESCUETECH SPIN-LOCK PULLEY

Uni-Directional Pulley

Great for raise / lower systems. Pulley sheave turns one direction making hauling easy and providing friction as the rope is belayed through the device.

Strength: 6,744 lbf. (30 kN) WLL: 1,120 lbs. (509 kg) Dimensions: 6.7" x 3.25 x 2.1" (167.5 x 8.3 x 52.5 mm) Weight: 26 oz. (737 gm) Rating: General Use
 Meets NFPA 1983/ANSI/OSHA strength specifications.



2014700 RT Spin Lock Pulley



SINGLE PULLEY WITH BECKET

Specialized rigging pulleys with aluminum or stainless steel sideplates and an aluminum sheave. By using the extra rigging hole at the bottom of the pulley, they can be daisy-chained together in block and tackle fashion.



		Dimensions		Weight	Strength	WLL	Max Rope Dia.	
20140344	Compact, Bushing	5" x 2"	126 x 52 mm	6.3 oz.	8,093 lbf.	800 lbs.	1/2"	13 mm
61083504	Prusik Minding, Bushing	6.25" X 3.5"	157 x 88 mm	12 oz.	11,240 lbf.	1124 lbs.	1/2"	13 mm
61083514	Prusik Minding, Bearing	6.25" X 3.5"	157 x 88 mm	12 oz.	11,240 lbf.	1124 lbs.	1/2"	13 mm



RESCUETECH MICRO PULLEY

A strong pulley in a small package. Made from alloy aluminum, this pulley is perfect for a variety of rescue uses. From Tower Rescue to Water Rescue the RT Micro is one of the most versatile pulleys around. Made for ropes 5/16" - 1/2" Diameter.

Strength: single: 8,093 lbf. (46.7kN) double: 8,093 lbf. (46.7kN) Weight: 3.2 oz. (90.7gm) 5.6 oz. (158.8 gm) Dimensions: 2.9" x 1.75" (72.5 x 43.8 mm) 3.5" x 1.75" x 2" (87.5 x 43.8 x 50mm) Rating: General Use
 Meets NFPA 1983/ANSI/OSHA strength specifications.



6101151	RT Micro - Black
6101154	RT Micro - Red
6101254	RT Micro Double - Red
6101251	RT Micro Double - Black



MICRO STRAP PULLEY

Economical Personal Use Pulley

Simple Sideplate design provides extra safety for rescuers. Ideal for 8mm - 7/16" ropes.

Color: Red Strength: 4,946 lbf. (22 kN) WLL: 495 lbs. (225 kg) Dimensions: 3.2" x 1.75" (75 x 43.75 mm) Weight: 3.2 oz. (90 gm) Rating: Technical Use
 Meets NFPA 1983/ANSI/OSHA strength specifications. BS EN 12278



2014037 Micro Strap Pulley



RESCUETECH STAINLESS STEEL PMP PULLEY

High strength pulleys designed for ropes up to 5/8" diameter. 2" and 3" sheave diameters. Features high grade stainless steel sideplates and aluminum or Stainless Steel pulley sheave. Extra large rigging point accepts two rescue carabiners. Available with bronze bushing or bearing.

Rating: General Use.

SINGLE PULLEY

		Sheave	Dimensions	Weight	Strength	WLL	Max Rope Dia.		
61082400	2" Single, Bushing	Aluminum	4 x 2.75"	10.1 oz.	8,993 lbf.	899 lbs.	1/2"	13 mm	\$48.00
61082410	2" Single, Bearing								\$65.50
61084400	3" Single, Bushing	Aluminum	6.25 x 4.15"	22.2 oz.	11,240 lbf.	1124 lbs.	5/8"	16 mm	\$80.00
61084410	3" Single, Bearing								\$97.00
61082500	2" Single - Bushing	Stainless	4 x 2.75"	13.5 oz.	8,993 lbf.	899 lbs.	1/2"	13 mm	\$63.25
61082510	2" Single - Bearing								\$82.50
61084500	3" Single - Bushing	Stainless	6.25 x 4.15"	31.8 oz.	11,240 lbf.	1124 lbs.	5/8"	16 mm	\$99.00
61084510	3" Single - Bearing								\$118.00



Single pulley



Double pulley w/ Becket

DOUBLE PULLEY W/ BECKET

		Sheave	Dimensions	Weight	Strength	WLL	Max Rope Dia.		
61082700	2" Double, Bushing	Aluminum	4 x 2.75"	16.9 oz.	8,993 lbf.	899 lbs.	1/2"	13 mm	\$77.00
61082710	2" Double, Bearing								\$107.00
61084700	3" Double, Bushing	Aluminum	6.25 x 4.15"	38.2 oz.	11,240 lbf.	1124 lbs.	5/8"	16 mm	\$80.00
61084710	3" Double, Bearing								\$157.00
61082600	2" Double - Bushing	Stainless	4 x 2.75"	23.9 oz.	8,993 lbf.	899 lbs.	1/2"	13 mm	\$99.50
61082610	2" Double - Bearing								\$138.00
61084600	3" Double - Bushing	Stainless	6.25 x 4.15"	57.5 oz.	11,240 lbf.	1124 lbs.	5/8"	16 mm	\$155.00
61084610	3" Double - Bearing								\$194.00

STAINLESS STEEL LITE PULLEY

High strength pulleys designed for ropes up to 5/8" diameter. 3" sheave diameters. Features high grade stainless steel sideplates and aluminum pulley sheave. Extra large rigging point accepts two rescue carabiners. Available with bronze bushing or sealed needle bearing.

Rating: General Use.

		Dimensions		Weight	Strength	WLL	Max Rope Dia.		
6102005	3" Single, Bushing	6.4 x 4"	160 x 100 mm	22 oz.	16,000 lbf.	1,600 lbs.	5/8"	16 mm	\$87.00
6102005D	3" Double, Bushing	7 x 4"	184 x 108 mm	38 oz.	20,000 lbf.	2,000 lbs.	5/8"	16 mm	\$141.50



STAINLESS STEEL PULLEY

Built to be tough and durable at an economical price. Plain sideplates with rigging points that accommodate two rescue carabiners. Stainless Steel sideplates and axle for extra durability. Available with sintered bronze bushing or needle bearing.

Rating: General Use



SINGLE PULLEYS

		Dimensions		Weight	Strength	WLL	Max Rope Dia.		
6102118	2" Bushing, Steel	5 x 2.5"	125 x 63 mm	11.6 oz.	8,000 lbf.	800 lbs.	1/2"	13 mm	\$61.00
6102118A	2" Bushing, Aluminum								\$55.50
6102122	4" Bushing, Aluminum	8 x 4.5"	200 x 112 mm	35 oz.	20,000 lbf.	2,000 lbs.	5/8"	13 mm	\$94.00
6102123	4" Bearing, Aluminum								\$104.00



DOUBLE PULLEYS W/ BECKET

		Dimensions		Weight	Strength	WLL	Max Rope Dia.		
6102119	2" Bearing, Aluminum	6.25 x 2.5"	162 x 62 mm	13 oz.	11,000 lbf.	1,200 lbs.	1/2"	13 mm	\$79.00
6102120	2" Bushing, Steel	6.25 x 2.5"	162 x 62 mm	20 oz.	11,000 lbf.	1,200 lbs.	1/2"	13 mm	\$83.50
6102120A	2" Bushing, Aluminum	6.25 x 2.5"	162 x 62 mm	13 oz.	11,000 lbf.	1,200 lbs.	1/2"	13 mm	\$76.00
6102124	4" Bushing, Aluminum	9 x 4.5"	225 x 112 mm	60 oz.	25,000 lbf.	2,500 lbs.	5/8"	16 mm	\$195.00



NFPA STAINLESS STEEL PULLEYS

Meets Construction and Strength Requirements of NFPA 1983

SINGLE PULLEYS

Rating: Technical Use Top to Bottom: 4" NFPA Single, 2" NFPA Single

DOUBLE PULLEYS

Rating: General Use Top to Bottom: 4" NFPA Double, 2" NFPA Double (not available)



		Dimensions		Weight	Strength	WLLMax Rope Dia.		
6103117	2" Single, Bearing	5 x 5.2"	125 x 63 mm	7.7 oz.	8,000 lbf.	800 lbs.	1/2"	13 mm
6103122	4" Single, Bushing	8 x 4.5"	200 x 112 mm	35 oz.	20,000 lbf.	2,000 lbs.	5/8"	16 mm
6103123	4" Single, Bearing	8 x 4.5"	200 x 112 mm	35 oz.	20,000 lbf.	2,000 lbs.	5/8"	16 mm
6103124	4" Double, Bushing	9 x 4.5"	225 x 112 mm	64 oz.	25,000 lbf.	2,500 lbs.	5/8"	16 mm
6103125	4" Double, Bearing	9 x 4.5"	225 x 112 mm	64 oz.	25,000 lbf.	2,500 lbs.	5/8"	16 mm

EASY LIFT EVACUATION PULLEY

For Ski Lift Rescues

Designed to be connected directly to the main ski lift cable for lift evacuations. Manufactured of alloy aluminum body, nylon sheave, and stainless steel gate. Must be used with back-up lanyard and belay system.

Works on cable up to 2.2" Strength: 6,745 lbf. Weight: 52.8 oz.

23896104

Evacuation Pulley



STAINLESS STEEL TROLLEY PULLEY

For Steel Cables

Sheaves turn on Sealed Ball Bearing for smooth, wobble-free use. Oversized stainless steel sideplates extend well beyond the sheaves to protect them from hard use. A rear slot allows a steel carabiner to surround the cable, allowing redundancy from the cable to the load.

Dual Hardened Sheaves that will accommodate 3/8" or 1/2" cable. Weight: 32.8 oz. Rating: Technical Use



ALUMINUM TRIPLE SHEAVE PULLEY

The only aluminum triple sheave pulley with rotating sideplates. Designed for 7/16" - 5/8" ropes. Can be reeved at any point on the line. High strength alloy aluminum construction with Oilite® Bushing or Sealed Bearing. Triple carabiner rigging point.

Color: Gold Strength: 15,000 lbf. WLL: 1,500 lbs. Dimensions: 10" x 4" x 4.5" Pitch Diameter: 3.5" Weight: 4.25 lbs. Rating: General Use

Meets NFPA 1983/ANSI/OSHA strength specifications for Pulleys



STAINLESS STEEL TRIPLE SHEAVE PULLEY

Super-Strong and Super-Durable. Rigging Hole accommodates 3 large rescue carabiners.

For rope diameters 3/8" - 5/8" Strength: 30,000 lbf. WLL: 1,500 lbs. Dimensions: 8" x 4.5" Weight: 5.25 lbs. Rating: General Use

Meets NFPA 1983/ANSI/OSHA strength specifications for Pulleys



6102221

Steel Cable

610034

4" Triple, Bushing

610034B

4" Triple, Bearing

6102134

Bushing

6102135

Bearing



RESCUETECH EXTRACTOR™ CSR HAULER

The EXTRACTOR™ CSR HAULER pulley features an integral safety cam to secure the progress of hauling systems. The first in a series of Rescue Technology pulleys that meet the rugged requirements of Rope Rescue Technicians, the EXTRACTOR™ CSR HAULER is designed for 1/2" Life Safety Rope and will accommodate ropes from 3/8" - 9/16". Special safety cam design is rope friendly and can be locked out of the way when a standard double pulley is needed. Super-strong, the EXTRACTOR™ CSR HAULER has an 1,100 lb. safe Working Load Limit. EXTRACTOR-LOK version has special "one-way" roller bearings that allow the sheaves provide friction manually holding the load or when lowering (EXTRACTOR is not a belay device).

Dimensions: 8.75" x 3.1" x 2.2" Rating: General Use

Meets NFPA 1983/ANSI/OSHA strength specifications.



MICRO CSR PULLEY



The perfect size for light use and tower rescues. Ideal for 8mm - 7/16" ropes. Works with ropes up to 1/2". Built-in safety cam holds rope for use in "Jigger" or "Short-Haul" Systems. Color: Purple

Strength: 7,000 lbf. (31 kN) WLL: 700 lbs. (318 kN) Dimensions: 6" x 2" (152 x 51 mm) Weight: 8.8 oz. (226 gm) Rating: Technical Use

Meets NFPA 1983/ANSI/OSHA strength specifications.

614321

Micro CSR Pulley

614024	RT Extractor CSR, Double
614025	RT Extractor-LOK, Double
614014	RT Extractor CSR, Single
614024C	Replacement Cam Release Cord



KNOT PASSING PULLEY

Ideal For Use As Carriage Pulley

Heavy duty knot passing pulley. Rotating sideplates and a rigging point that will accommodate three 13mm rescue carabiners. Aluminum pulley sheave with Oilite® Bushing for durability. The Wide Pulley is designed for ropes up to 1/2" diameter. The large hole in center of the sideplates will accept an Pear Shaped Scaffold Hook carabiner for balanced hauling when unit is used as the top support pulley in rope traverse systems.

Color: Red

Meets NFPA 1983/ANSI/OSHA strength specifications for Pulleys

KOOTENAY PULLEY

Designed for passing knots in rope.

High efficiency sealed ball bearings. Locking pins allow use as an anchor.

Fits ropes from: 5/16" to 3/4" Strength: 8,992 lbf. Dimensions: 4" x 2" x 1.75" Weight: 50.4 oz. Height: 10.25" Rating: General Use



STAINLESS STEEL CARRIAGE PULLEY

Durable Aluminum Sheave

The most versatile Knot-Passing / Highline pulley yet. Extra-wide 3" sheave easily passes knots in 1/2" rope. Large center rigging hole accepts up to three large carabiners, two smaller holes provide tagline attachments. Pins stowed directly on sideplates install to lock the sheave, allowing the pulley to be used as a high-strength tie off.

Strength: 15,000 lbs. Efficiency: 91.4% Dimensions: 8.5" x 4" Weight: 40 oz. Rating: General Use

Meets NFPA 1983/ANSI/OSHA strength specifications for Pulleys

610015	Medium
610016	XLarge

2354067

Kootenay Pulley

6102143

S.S. Carriage Pulley



ROCK EXOTICA OMNI-BLOCK PULLEYS

The Rock Exotica™ OMNI BLOCK® is a mix of the old and the new. Up to now, rescue pulleys have been the standard side swing plate models that involve rotating the side plate and the introduction of the rope into the sheave. Increased strength is cited as the main reason that life safety pulleys are designed this way. Incredibly quick to attach, the Rock Exotica Omni Block is a high strength, swiveling rope block/pulley. Each precision fabricated alloy block has a unique button-activated release feature that allows instant access to the sheave for midline attachment. The attachment eye accepts most carabiners and snaps.

Pulley 1.5" and accepts up to 1/2" rope. Strength: 8,093 lbf. (36 kN) WLL: 899 lbs. (409kg.) Pulley Tread Dia.: 1.6" Dimensions: 5.25" x 2.5" Weight: 8.8 oz. (single) 14.4 oz. (Double) Rating: General Use

Meets NFPA 1983/ANSI/OSHA strength specifications for Pulleys

		Color
2438161514	1.5 Single	Red
2438161511	1.5 Single	Black
2438162514	1.5 Double	Red
2438162511	1.5 Double	Black



2.0 PMP

The Omni Block 2.0 features a 2" sheave for better efficiency when hauling heavy loads.

Fits ropes up to: 1/2" (13mm) diameter Sheave Diameter: 2.0" (51mm) Strength: 8,093 lbf. (36 kN) WLL: 1799 lbf (8 kN) Dimensions: 5.8 x 3" (148 x 76mm) Weight: 12.3 oz. (344 gm)

		Color
243816310	Single	Copper
243816320	Double	Copper



ROCK EXOTICA AZTEK OMNI PULLEY SET

The special Rock Exotica pulley used in the Aztek "set-of-fours" system. When configured, these double blocks will enable the rescuer greater versatility in a personal mechanical advantage (PMA) for rescue and general rigging. Machined from a solid block of high strength aluminum the Aztek pulleys have two different style blocks and are color-coded for ease of identification.

Strength: 8,093 lbf. (36 kN) Dimensions: 4" x 2" x 1.75" Rating: General Use

Meets NFPA 1983/ANSI/OSHA strength specifications for Pulleys.

	Description
243816410	Aztek Pulley Set
243816419	Aztek Pin

OMNI-BLOCK 2.0

A PMP version of Rock Exotica's Omni Block. The Omni-Block 2.0" features a one-sided PMP function and swiveling rigging point.

Weight: 12.3 oz (348 gm) Breaking Strength: 8,093 lbf (36 kN) Working Load: 800 lbs. (8 kN) Max Rope Diameter: 1/2" (13 mm) Sheave Diameter: 2.0" (51 mm)

		Color
24381615210	2.0 Single	Red
24381615211	2.0 Single	Black
24381615220	2.0 Double	Red
24381615221	2.0 Double	Black

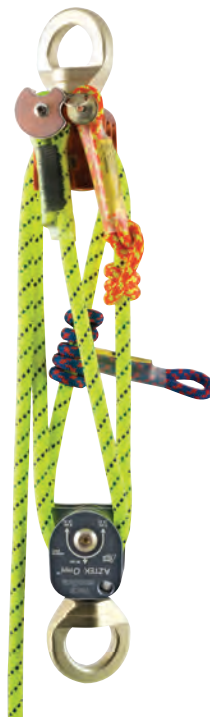

AZTEK 4:1 EDGE MANAGEMENT PULLEY SET

This is a compact mechanical advantage system that provides rescuers with a versatile edge management and rigging set. Some of the uses are as a pick off, travel restrict, adjustable directional, high directional guy-line, high angle attendant tether, high angle litter scoop, load release hitch and much more. Both AZTEK pulleys have their own color-coded Prusik and can be easily activated or deactivated. This means you can have the ratchet at either the top pulley or the bottom pulley. The special 3 on 2 Prusik cannot come off the rope, so the deactivated Prusik will stay ready to be used as soon as you need it. Set includes AZTEK Pulleys, Aztek rope set (50' of 8mm, 2-6mm Ratchet Loops, 1-6mm Travel Restraint Loop) and waist pack.

	Description
61051301	Aztek (shown)
61051500	Aztek-Pro



ANTHRON HANDLED ASCENDER

A great new handled ascender.

Manufactured of aluminum, the Anthron fits ropes 9mm - 1/2" in diameter. Special grip material on handle is very comfortable and is slip-resistant.

Dimensions: 7.6" x 3.6" (190 x 90mm) **Weight:** 8.5 oz (204 gm) **Rating:** General Use

Meets NFPA 1983 strength specifications for ascenders.

		Color
602301	Left Hand	Gold
602302	Right Hand	Blue



ANTHRON BLOQUER MINI ASCENDER

Ascender for Rope Access

Manufactured of aluminum, the Bloquer fits ropes 9mm - 1/2" in diameter. The Bloquer may be used as a chest or small ascender. It may be attached to the harness with flat webbing or carabiner. It possess an auxiliary hole into which a second carabiner can be inserted, preventing so the rope from falling out of the groove during climbing. Works with our new VANGUARD II, PRIME, and ADVANTAGE harnesses. Fits ropes 8mm - 1/2".

Color: Blue **Dimensions:** 4.75" x 3.25" x 1.4" (118.8 x 81.3mm) **Rating:** General Use

Certified EN567. Meets NFPA 1983 strength specifications for ascenders.

602305	Bloquer Ascender
--------	------------------



ANTHRON CHEST ASCENDER

Chest Ascender for Rope Access

Manufactured of aluminum, the Anthron fits ropes 9mm - 1/2" in diameter. Works with our new VANGUARD II, PRIME, and ADVANTAGE harnesses.

Color: Blue **Dimensions:** 4.6" x 2.9" (115 x 72.5mm) **Weight:** 4.9 oz. (118 gm) **Rating:** General Use

Meets NFPA 1983 strength specifications for ascenders.

602306	Chest Ascender
--------	----------------



Top: Ultrascender (Black)
Bottom: Ultrascender (Red)

ULTRASCENDER



One of the strongest open-sided ascenders available. Machined from solid aircraft aluminum extrusion with 4140 chrome-moly steel cam with a new non-metallic finish that has the same corrosion resistance as stainless steel and is harder than knife blades and files. The unit will accommodate ropes from 1/4" (6mm) to 5/8" (16mm) in diameter. Special safety gate design is superior to other open-sided ascenders. Attach to carabiners, ascender slings, or combination. Set includes one right and one left hand unit.

Strength: 5,000 lbf (22.2 kN) **Weight:** 20 oz. (480 gm) **Rating:** General Use **Dimensions:** 7.25" x 3" (181.3 x 75mm)

Meets NFPA 1983 strength specifications for ascenders.

		Color
6020031N	Pair	Black
6020034N	Pair	Red



ISC PRO ASCENDER

ISC PRO Ascenders are manufactured from solid Aluminum fitted with Stainless Steel cams with cones (rather than spikes), to minimize rope wear. All ISC Hand Ascenders have both primary and secondary attachment holes and molded comfort-grip handles. Durable anodized coating.

EN567, NFPA Compliant. Weight: 12.3 oz (350 gm)

	Description
201418210	Left Hand
201418220	Right Hand



ISC RED BACK-UP DEVICE

Designed to replace current mechanical prusiks. ISC designed the RED to accommodate the safety needs of the rope access market. Fully CE approved to EN1284. The RED will take on a two-person rescue load, is self-parking (rather than self-tailing) and is towable so as to be used with current web and rope lanyards. The RED's cams have a positively locking spring which maintains the devices position on the rope. Another RED feature is the use of "rotational braking" When loaded, the RED rotates clockwise in relation to the main line creating friction resulting in a very effective automatic braking. Panic braking accomplished by pulling on the "Popper" break-away tow cord. Rated capacity: 528 lbs (240 kg). Peak loads under 6 kN. Self-Parking. Compatible with RescueTECH 7/16" ACCESS Lifelines (other ropes may be tested on request).

20148924	RED Backup w/ Popper
20148914	RED Backup w/ Cord
20148904	RED Backup



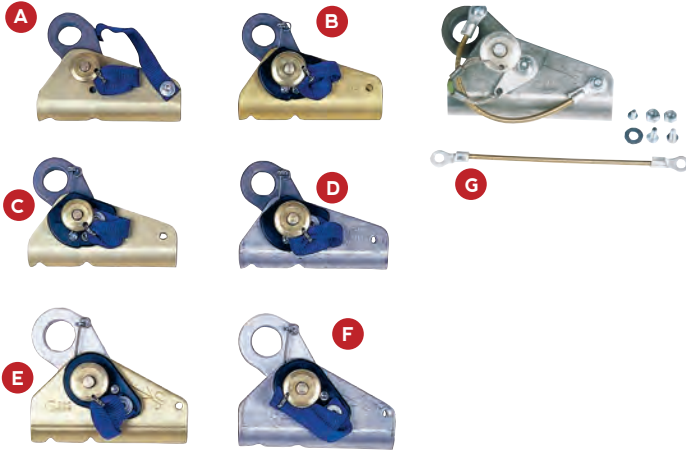

GIBBS ASCENDER

New Spring Design

One of the strongest closed cam type of rope-grab ascenders. Rounded tooth cam design minimizes rope wear yet holds on wet or icy ropes. New spring attachment increases cam's range of motion to decrease chance of spring breakage. 1/2" model attaches to synthetic ropes 5/16" to 1/2"; 3/4" version accommodates synthetic ropes from 5/8" to 3/4". The spring-loaded type is always in locked position and is recommended for general rescue use. For use on kernmantle rope only.

Meets NFPA 1983 strength specifications for ascenders.



		Cam Type	Strength	Weight	Rating
A. 602011	1/2" Aluminum, Free Running	Forged	2,550 lbf.	7 oz.	Technical
B. 602012	1/2" Aluminum, Spring Loaded	Forged	2,550 lbf.	7 oz.	Technical
C. 602012F	1/2" Aluminum, Spring Loaded	Forged	5,000 lbf.	9.2 oz.	General
D. 602112	1/2" Stainless Steel, Spring Loaded	Forged	5,400 lbf.	12 oz.	General
E. 602013	3/4" Aluminum, Spring Loaded	Forged	5,650 lbf.	14 oz.	General
F. 602113	3/4" Stainless Steel, Spring Loaded	Forged	5,650 lbf.	20 oz.	General
G. 602201	Replacement Spring Kit (Ascender not included)				



Carabiner not included.

ASAP®

Mobile fall arrest device for rope.

- For use on 11 - 13mm lifelines • Stops a fall, a slide or uncontrolled descent • Locks even if the device is grabbed during a fall • Works on vertical or angled rope • Moves up and down along the rope without manual intervention • Easy to install/remove at any point on the rope • Can be used with an energy absorbing lanyard

23540271
2354027102
2354127120
2354127140



GIBBS SLINGER™

We combine the rescue versions of the 1/2" Gibbs Ascender with our high strength 1" Flat web to create a versatile rope grab system that virtually eliminates torsion loads on the rope grab and carabiner.

Meets NFPA 1983 strength specifications for ascenders.

602212A	Aluminum
602212S	Stainless Steel



ISC RESCUE ASCENDER

New Pin Design

Manufactured from high strength aluminum alloy. Machined from thick walled extrusion for extra durability. Shell has special curved rope interface section for superior rope strength and minimized rope damage. Rigging point will accommodate all of our carabiners and will pass many locking collars. Quick-attach pip pin for easy attachment. For use on kernmantle rope only.

Rating: General Use

Meets NFPA 1983 strength specifications for ascenders. BS EN 567 Certified as Rope Clamps

		Rope Dia.
602251	Standard	7/16" - 1/2"
602252	Large	5/8"

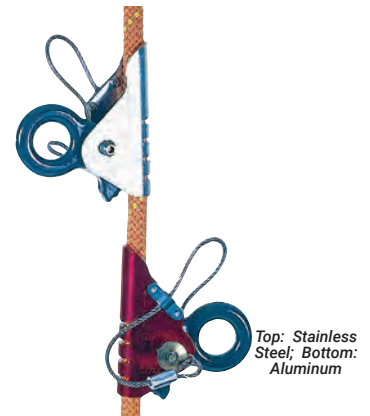

Top: Stainless Steel; Bottom: Aluminum

CMI ROPEWALKER ASCENDER

Manufactured from alloy aluminum or stainless steel and forged aluminum cam. Large attachment point accommodates multiple carabiners. Unique spring design allows for easy adjustment of tension. Spring tested to over 1 million cycles. 3/8" to 5/8" diameter rope capacity. Pin can be inserted from either left or right side to accommodate needs of rescuer. 3 sigma rated to 7,700 lbf. For use on kernmantle rope only.

Rating: General Use.

Meets NFPA 1983 strength specifications for ascenders.

602241	Aluminum
602245	Stainless Steel



ASCENDER SLING SET

Designed for use with handled ascenders to allow rescuer to climb back up a rope. Manufactured of high quality 1" nylon webbing (Tensile Strength: 6,000 lbf.). One sling attaches to a seat harness, the stirrup connects a second ascender to the right or left foot.

Weight: 7.2 oz./pair Color: Orange

	Size	Height
602300	Medium	up to 6'
602400	Large	over 6'



DOUBLE FOOT SLING

For those time where a single foot loop will not work, the RescueTECH Double Foot Sling fits the need. A handy sling that, when used with a handled ascender, allows the rescuer to climb up a rope. Easily attaches to ascender with rapid link or girth hitch. Foot loops held open by special stiffener.

6024321	Double Foot Sling
60510106	Connector Link



DELUXE ASCENDER SLING SET

Can be configured for both Texas and "Frog" style ascending systems. Simply attach slings via rapid link or girth hitch to ascenders. Adjustable harness attachment slings give this set a wide size range. Manufactured of high quality 1" nylon webbing. Two slings attach to a seat/chest harness. The double foot loops connects a second ascender to the rescuers feet. Special adjuster for the foot loops help prevent loops from sliding off boots. Kit includes: Ascender sling set, Ascenders (2), carabiner, rapid links (2), and storage pouch.



Ascenders, Rapid Links and Carabiners included in Kit only

6024334	Deluxe Ascender Sling Set
6024334A	Deluxe Ascender Sling set w/ Ascenders



ADJUSTABLE FOOT SLING

A handy sling that, when used with a handled ascender, allow the rescuer to climb up a rope. Easily attaches to ascender with rapid link (link not included). Adjustable length.

6024301	Adjustable Foot Sling
60510106	Connector Link



REMOTE RETRIEVAL HOOK

Hold-Tite Pole Adapter Holds Hook

A Retrieval Hook that allows the attachment of a retrieval line to an entrant without entering the confined space. The Remote Retrieval Hook is held open so the rescuer can connect it to a harness D ring. As soon as the snap is engaged a simple tug will lock the Hook to the harness. Sling may be attached to end of retrieval line for victim rescue. Comes complete with auto-locking snap and nylon sling. Extension Pole with Hook Adapter sold separately. Hook Materials: Stainless Steel w/ protective plastic shroud.

Gate Opening: .75" Hook Strength: 5,000 lbs.
Remote Retrieval Hook and Pole sold separately.

		Height
616101	Retrieval Hook w/ Sling	
616112	Extension Pole	6' - 12'
616124	Extension Pole	8' - 24'
616200	Storage Bag	6' - 12'
616210	Storage Bag	8' - 24'



SUPERCLIP RESCUE TOOL

Extend Rescuers' Reach

Superclip Rescue is designed for remotely holding autolock carabiners in the open position. Great for confined space rescue situations. Holds most Autolocking 3 Stage Carabiners. Pole kits include Superclip Rescue Tool, 3-Section Pole, and Supersafe 3-stage ANSI carabiner w/ sling. 4-12' Kit collapses to easily fit into most standard compartments.

Weight, Clip: 1.6 oz.



2462002	Super Clip (only)
2462112	4 - 12' Pole Kit w/ Carabiner/Sling



INDUSTRIAL ROPE GRAB WITH LANYARD

For Vertical Lifelines

Stainless steel fall arrest device especially designed for vertical applications. Unlike other cam-type grabs, these grabs slip before rope failure. Rope Grab clutching effect begins at 1,000 lbf. on 1/2" ropes. For this reason use **ONLY** on the correct diameter rope. These grabs have the 2" diameter rigging hole to prevent rollout of attaching snaps. Comes with a permanently attached nylon lanyard equipped with a double locking snap hook. Manufactured in the U.S.A.

Weight: 1.5 lbs. **Rating:** General Use

Meets all OSHA, NFPA, CSA, and ANSI standards for rope grabs and ascenders.



FOOT ASCENDER

A compact foot ascender for rope climbing systems. Machined from aluminum extrusion. Locking mechanism holds unit on the rope. Includes adjustable webbing straps.

602247	Right
602248	Left



6025241	1/2" Ropes
---------	------------



ROCKER



The Rocker can be fitted to the rope at any point. It can be used hands-free, when travelling up and down the rope and has been designed for use without a Shock-absorber. The Rocker can also be used as a Rope Adjuster on a Work Positioning Lanyard or Flip-line (in accordance with EN358). The Thumb-catch allows the Rocker to be 'parked' on the rope for Work Positioning or use as a Rope Access back-up device. Non-aggressive 'rope friendly' cam faces reduce wear on rope. Designed for 7/16" ropes.

602600	Rocker, Aluminum
--------	------------------



STEEL CABLE GRAB

Only For Use on 3/8" Steel Cable

Designed for use on 3/8" diameter steel cable. Manufactured from steel for durability. Can be attached and removed from the cable at any point. Slight spring tension keeps the unit in the locked position unless upward pressure is applied to the pivot arm. Exceeds applicable OSHA/ANSI regulations.

Weight: 34 oz.



ROCKER ADJUSTABLE LANYARD

Work positioning lanyard with a Rocker Adjuster and a sewn-on aluminum snap. The Rocker Adjustable Lanyard features the ISC Rocker, Aluminum Autolocking Snap, 7/16" Access Lifeline, and Autolocking Oval Steel Carabiner. A 24" wear-protector is included. Color: Rocker (Red), Rope (White w/ Red Stripes).

7515472029	2 Meter
7515472039	3 Meter



ISC RAD POSITIONING LANYARD

Adjustable positioning lanyard using the RAD Rope Adjusting Device with handle from ISC. High strength and easy adjustability. Includes RAD Adjuster, Rope with sewn eyes, and Autolocking Hook (red on right) or Snap (silver, on left).

2014815112	RAD Lanyard, Snap - 2 M
2014815113	RAD Lanyard, Snap - 3 M
2014815232	RAD Lanyard, Hook - 2 M
2014815233	RAD Lanyard, Hook - 3 M

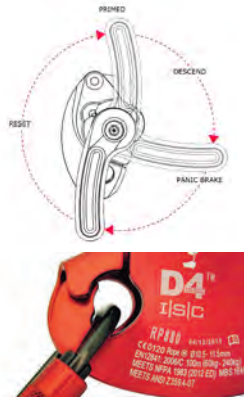

ISC D4/D5 BELAY DESCENDER

With Panic Brake

Special descender / belay device that easily controls 500-600 lb loads. Side plate rotates to the closed position with a low-profile, spring loaded safety catch. Simple functional design. Can be placed onto the rope without removing rigging carabiner. Rotate handle counter-clockwise to lock in place. Rotate right to descend or lower load. Rotating handle too far clockwise will engage panic stop function. Continued clockwise rotation re-sets the unit. The ISC D4 and D5 are true panic stop devices rather than panic brake devices. The difference is that once the panic stop is activated, no other force must be applied to the device. A panic brake style device requires a force input to continue the braking function. Can be used for progress capture in hauling systems and allows rapid conversion between raising and lower. 4mm high strength sideplates and stainless steel cam for superior durability. D4 for 3/8 - 7/16" ropes; D5 for 7/16" - 1/2" ropes. "Integral wear indicator"

D5 meets: NFPA G, ANSI Z359.4, CE, Meets BCCTR.

	Description	MBS (lbf)	WLL	Rope Size	Dimensions	Weight	Colors
2014880x	D4 Belay	3597	500 lbs	10.5 - 11.5mm	5.5" x 3.25" x 3.78"	23 oz.	Red, Black
2014882x	D5 Belay	4950	530 lbs	11.5 - 13mm	6" x 4" x 3.5"	28.8 oz.	Red, Black



D4 PRO

The D4 Work/Rescue Descender has proven to be a popular Descender amongst Rope Access & Rescue users, all over the world. Many users value the extra peace of mind of having a panic-brake function. Using feedback gathered from highly qualified and experienced 'Pro' users highlighted a demand for a device which does not incorporate a panic-brake function. Thus the D4PRO was created. The D4PRO Descender is the same great Work/Rescue Descender as the D4, but **without the panic brake**. This can be particularly useful on longer descents and in rescue/belay applications, where a broader 'sweet spot' is welcomed.

Rated Load: 550 lbs (240 kg); Rope Size: 7/16" (10.5 - 11.5mm); Weight: 24 oz. (676 gm). Standard: EN12841

		Rope Dia.	
60100971	Anthron Descender	Black	\$120.00



ISC A-B DESCENDER

Superior Control vs. Competition

Special descender with a 500 lb. Working Load Limit. Complete with a double action anti-panic handle. Manufactured from aluminum alloy. 100% inspected and function tested. Works on rope diameters: 10.5 - 12mm. ALWAYS test your personal rigging method to assure sufficient friction for a safe descent.

Dimensions: 8" x 3" (200 x 75mm) Strength: 5,000 lbf. (22.2 kN) Rating: General Use

Meets NFPA 1983/ANSI construction specifications for Descenders.

601340	ISC A-B Descender
--------	-------------------



ANTHRON DSD PLUS DESCENDER

Descender with double locking and anti-panic system: self braking in case of accidental loss of descent control. Sensitive rubberized handle enables smooth descent without harmful rope twisting. No movable flanges which makes it a robust and less likely for mistakes. No need to unclip the device for rope insertion. Also suitable for work at a height and for emergency self evacuation. Rope and carabiner not included. DSD PLUS Features: • Longer Handle – allows gentle and progressive braking • New Cam Tested for higher loads enhanced braking in both stop positions. • Diminished possibility of incorrect insertion of the rope. • Even incorrect insertions will not result in a fall as the rope is blocked. • Integrated WEAR INDICATOR. • High strength plain bearing added to the pivoting cam.

Strength: 4946 lbf (22 kN) Weight: 140 grams Rope diameter: 7/16" (11mm)

Certification: EN 341 Class2A:2011 and - EN 12841 TypeC:2006

60100871	DSD Plus
----------	----------



ANTHRON DOUBLE STOP DESCENDER

A manually operated controlled descent device that utilizes a cam assembly that provides friction on the rope to hold a load, or allow the load to descend. To begin descent, the user depresses the control lever. If the control lever is fully depressed in a panic situation, the descent will stop. Normally, connected directly to the users seat harness, the Anthron may be attached to a rigging point and used as a lowering device. Can be placed on the rope at any point. For 3/8" - 7/16" ropes. Best control with 7/16" ropes.

WLL: 300 lbs. (136.4 kg) Dimensions: 7.5 x 3.3" (187.5 x 82.5mm) Weight: 13.6 oz. (386 gm)

Meets NFPA 1983/ANSI construction specifications for Descenders.

		Rope Dia.
60100971	Anthron Descender	Black

ROCK EXOTICA ENFORCER LOAD CELL

Rescue Load Cell

Compact aluminum load cell that measures force up to 4,500 lbf (20 kN). Two sampling modes allows monitoring of rescue systems, and log drop testing in high resolution. Unique features like Bluetooth connectivity and swivel attachment. Includes custom Case. Lightweight aluminum construction. Compact & portable design facilitates "in-line" use in rigging systems. Swivel attachment points diminish potentially dangerous torsional and off-axis forces. Features two sampling modes: "Slow" for monitoring and "Fast" for drop testing. Monitor forces wirelessly on your iPhone with built-in Bluetooth connectivity.(Enforcer app required. Sold separately) Record and download graphs of 4-second dynamic events. Measures and records maximum force in kg, lbf and kN.

Max Reading: 4500 lbf (20 kN) MBS: 8093 lbf (36 kN) Accuracy: +/- 2% Length: 8" (203mm) Width: 2.1" (53mm) Weight: 14 oz. (397 gm) w/ batteries Certification: EN795 & EN354 CE 0120



243812031

Enforcer Load Cell



PETZL I'D® NFPA

For Descending and for Belaying, with an Anti-Panic function.

Swinging side plate with safety catch decreases risk of dropping device and allows rapid installation of the rope into the device. Anti-error feature helps avoid accidents due to incorrect installation of the rope in the device. Self-braking system: if the handle is released during descent, the cam rotates to pinch the rope and brake the user's descent. Anti-panic handle: the I'D® will lock onto the rope if the user pulls too hard on the handle. To descend, simply pull on the handle; the rate of descent is controlled by varying the grip on the free end of the rope with the other hand. For work positioning, the handle can be rotated to secure the I'D® in place on the rope, thus eliminating the need to "tie off" the device. May be used as a progress capture device in a haul system; allows rapid conversion between raising and lowering. Individually tested.

Weight: Large: 22.4 oz. (625 gm) NFPA Rating: General Use

CE EN 341 class A, Large: NFPA G. Small: NFPA

		Rope Dia.
2354120N	Large - NFPA G	11.5-13 mm
2354120S	Small - NFPA L	10 -11.5 mm



540 RESCUE BELAY

A mechanical belay device specifically engineered for fire service and industrial rescue teams. Simple and easy to use. Symmetrical design allows for bi-directional loading. Self-locking with sudden falls. Built-in release lever eliminates need for release hitch. Passes rescue belay competence criteria. UL Certified NFPA 1983. 1 year manufacturer's warranty.

Strength: 9,000 lbf. (40 kN) Weight: 24 oz. (680 gm) Rating: General Use

2154540	Large (11.5 - 13mm)
2154541	Small (10.6 - 11.6mm)
899522	540 Belay Video



WARNING

Technical rescue and safety is potentially hazardous. Any person using equipment sold by RESCUE TECHNOLOGY in any manner is personally responsible for learning the proper techniques involved, and assumes all risks and accepts full and complete responsibility for any and all damages or injury of



RESCUETECH™ STEEL RESCUE 8

Three Dimensional Design

Forged Steel Rescue 8 Descender. For ropes up to 3/4" diameter. Three dimensional design allows user to vary friction depending on which way the descender is used. Drop forged. Chromium Plated Silver.

Tensile Strength: 15,000 lbf. (66.7 kN) WLL: 1,500 lbs. (682 kg) Dimensions: 6.5" x 6" (16.5 x 15.2 cm) Weight: 24 oz. (680 gm) Rating: General Use

Meets NFPA 1983/ANSI construction specifications for Descenders.

	Color
6010070	Silver
6010071	Black



RESCUETECH™ STAINLESS STEEL COMPACT RESCUE 8

A small rescue 8 with the durability and strength of Stainless Steel. Only 5.7" long, this tough unit will fit into almost all rescue kits.

Dimensions: 5.7" x 5.3" (14.5 x 13.5 cm) Weight: 15.2 oz. (431 gm) Strength: 9000 lbf.

240180510



Descender Link shown with BailOut 8 (not included)

RESCUETECH™ DESCENDER LINK

A multiple loop extension for descenders. Built with the same high strength design as our daisy chains, the directional loops allow multiple adjustments of the overall length of the descender system.

Weight: 2.4 oz. (68 gm)

758124 Descender Link



RESCUETECH™ ISC RESCUE 8 DESCENDER

Our alliance with ISC has created several new items such as this classic aluminum rescue descender. Made from forged aluminum for great wear resistance.

Dimensions: 6.75" x 6" (17.2 x 15.2 cm) Weight: 7.2 oz. (204 gm) Minimum Strength: 7,886 lbf. (35 kN) Rating: General Use

Meets NFPA 1983/ANSI construction specifications for Descenders.

	Color
60114111	Charcoal
60114110	Silver



CMI 8 DESCENDERS

The Original Rescue 8

Cold forged design with durable hard-coat anodized finish. Rescue 8 has "ears" to aid in "locking-off."

Color: Charcoal Dimensions: Large: 6.6" x 6" (16.8 x 15.2 cm); Small: 5.5" x 2.73" Size: Large: 8 oz. (227 gm); Small: 4.8 oz. (136 gm) Rating: General Use

Meets NFPA 1983/ANSI construction specifications for Descenders.

		Weight
601000N	Rescue 8	8 oz.
601001N	Regular 8	4.8 oz.



RESCUETECH™ FIGURE 8

Traditional Design

The RescueTECH Figure 8 is an economical anodized figure 8 descender for light duty use. Forged aluminum construction.

Rappel/Belay Usage Strength: 7,000 lbf (31 kN) WLL: 700 lbs. (318 kg) Dimensions: 5 1/2" x 2 7/8" (14 x 7.3 cm) Weight: 4 oz. (113 gm) Rating: General Use.

Meets NFPA 1983/ANSI construction specifications for Descenders.

	Color
601311	Black
601316	Blue



RESCUE 9

A modified Rescue 8 Descender that features a rigging eye set at 90 degrees from the rescue 8. The rigging eye helps to properly position the unit, without twisting, when attached to the harness. Top pin allows for additional friction and a easier lock-off. Anodized forged aluminum construction.

Rating: General Use Weight: 7 oz. (195 gm) Rope diameter: 5/16" - 1/2" (9 - 13mm) MBS: 7,868 lbf. (35 kN)

	Color
60114201	Black



Technical rescue and safety is potentially hazardous. Any person using equipment sold by RESCUE TECHNOLOGY in any manner is personally responsible for learning the proper techniques involved, and assumes all risks and accepts full and complete responsibility for any

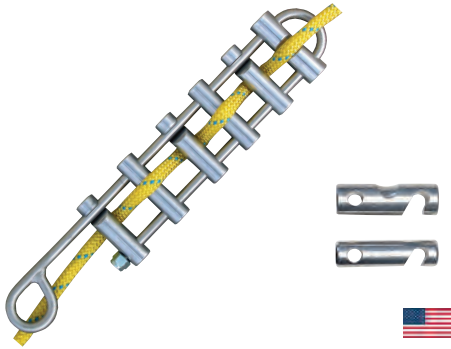

RESCUETECH RAPPEL RACK

This is the classic design developed in the 1960's. Primarily designed as a personal rappel device on a single rope 3/8" to 1/2" in diameter. Top Bar and Top Bar - Hyperbar has a training groove on one side to assist in guiding the rope and aid in proper rigging.

Length: 14" (35 cm) Weight: 24.8 oz. (703 gm) Rating: Technical Use

Meets NFPA 1983/ANSI strength specifications for Descenders.

601024W Rappel Rack

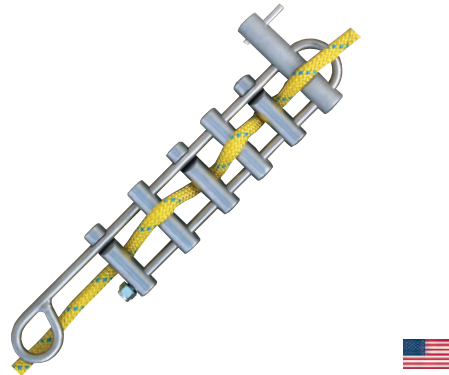

RESCUETECH RESCUE RAPPEL RACK

This is an upgraded version of our popular rappel rack. Large bars provide greater strength and control of rescue loads. Top Hyperbar aids in lock-offs. Grooved bars help guide the rope through the rack.

Length: 14" (35 cm) Weight: 28.8 oz. (816 gm) Rating: General Use

Meets NFPA 1983/ANSI strength specifications for Descenders.

601124 RescueRappel Rack

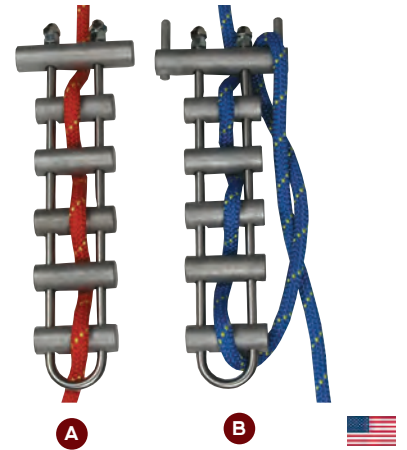

RESCUETECH RESCUE RACK™

Superior Control of Rescue Loads

The safest, heavy duty lowering and rappelling device. Can be placed onto rope at any point. Friction can be varied by sliding easily rigged bars up or down - even while on rappel or during lowering operations. Specially designed straight cut 1" aluminum friction bars help prevent mis-rigging. Extended top bar for quick lock-off. Accommodates ropes from 1/4" to 1 1/2" or double ropes up to 3/4". One person can easily control a 1,000 lb. load. Frame manufactured of 304 stainless steel and will accommodate four 13mm carabiners. Special design of the frame distributes the load between both sides of the unit.

Tensile Strength: 10,000 lbf. (44.5 kN) WLL: 1,000 lbs. (455 kg) Dimensions: 14" (35 cm) Weight: 35.2 oz. (997 gm) Rating: General Use

Meets NFPA 1983/ANSI strength specifications for Descenders.

A. 601102	Standard
B. 601202	Hyperbar

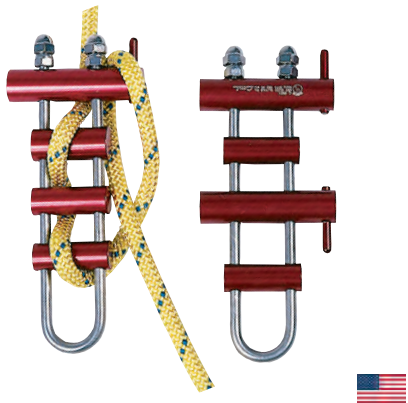

CMI MINI RESCUE RACK

A handy alternative for shorter drops and lighter loads. Similar in design to the standard CMI Rescue Rack by uses 5/16" Stainless Steel for the frame and aluminum for the brake bars. Top bar is oversized with a single lock-off pin. Pre-assembled with two fixed and two straight slotted bars.

Weight: 11 oz. (311 gm) Dimensions: 8.25" x 3.5" (20.6 x 9 cm) Strength: 14,000 lbf. (62 kN) WLL: 1400 lbs (636 kg) Rating: General Use

Meets NFPA 1983/ANSI strength specifications for Descenders.

601112	Standard HyperBar
601113	Double HyperBar

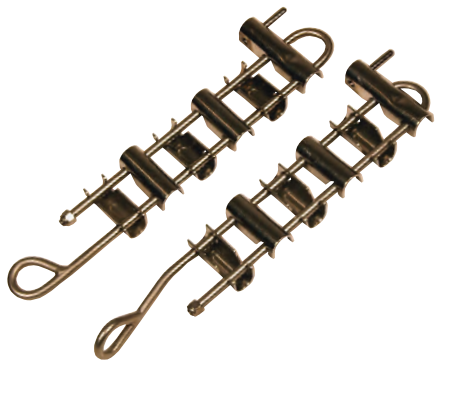

CMI NFPA RAPPEL RACK WITH HYPERBAR

Welded eye construction available in parallel or 90° to the bars. All welds are Zyglu inspected to insure reliability. The rack comes pre-rigged with six angle slotted Stainless Steel bars.

Length: 15" (38.1 cm) Weight: 31.2 oz. (884 gm) Strength: 10,000 lbf. (44.5 kN) WLL: 1000 lbs. (455 kg) Rating: General Use

Meets NFPA 1983/ANSI strength specifications for Descenders.

601034N	Standard
6010349N	90° Rigging Point

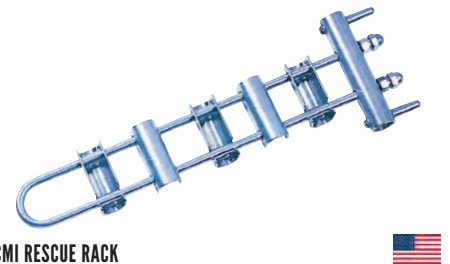

CMI RESCUE RACK

Oversized Aluminum Top Bar and Stainless Steel Friction Bars

3/8" diameter stainless steel frame fitted with oversized aluminum top bar and 5 stainless steel brake bars. To compensate for the reduced friction inherent in stainless steel bar, the diameter of the friction surface is a full 1". The special "open back" design of the bars help avoid improper rigging. Hyperbar model features stainless steel top bar with two lock-off pins.

Length: 15" (38.1 cm) Strength: 19,000 lbf. (84.5 kN) Weight: 32.8 oz. (930 gm) Rating: General Use

Meets NFPA 1983/ANSI strength specifications for Descenders.

601115	Standard	Weight
		32.8 oz.



CAUTION: Care must be CAUSTaken when using the Steel Brake Bars to rappel, belay, or lower personnel or heavy loads. Steel does not provide as much friction as aluminum.

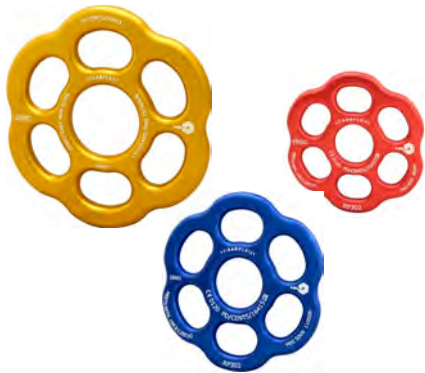

HALO RIGGING RINGS

An updated version of our standard rigging plates. The circular design, coupled with the large interior hole, allows riggers to apply loads to the rigging holes without the see-sawing effect as forces on the different holes change.

	Description	Color	Strength	WLL	Diameter
6032244	Small	Red	8,992 lbf. 40 kN	900lbs.	4.57" 115mm
6032256	Medium	Blue	11,240 lbf. 50kN	1125lbs.	5.72" 144mm
6032262	Large	Gold	15,737 lbf. 70kN	1575 lbs.	6.55" 165mm
6032241	Small	Black	8,992 lbf. 40 kN	900lbs.	4.57" 115mm
6032251	Medium	Black	11,240 lbf. 50kN	1125lbs.	5.72" 144mm
6032261	Large	Black	15,737 lbf. 70kN	1575 lbs.	6.55" 165mm



MAGNUM RIGGING PLATE

Large size and 15 holes to accommodate multiple rigging needs. Manufactured of alloy aluminum.

Strength: 12,365 lbf. (55 kN) WLL: 1,236 lbs. (562 kg)
 Length: 9.75" (249mm) Width: 5.875" (150mm) Hole Size: 3/4" (19mm) Weight: 16 oz. (471gm) Rating: General Use

603216

Magnum Rigging Plate



TECHNICAL RESCUE RIGGING PLATE

A standard size multi-hole rigging plate. Manufactured of alloy aluminum.

Strength: 12,365 lbf. (55 kN) WLL: 1,236 lbs. (562 kg)
 Length: 6.25" (165.6mm) Width: 3.75" (108mm) Hole Size: 3/4" (19mm) Weight: 8 oz. (262gm) Rating: General Use

603215

Technical Rigging Plate



MICRO RIGGING PLATE

The smallest rigging plate in the Rescue Technology line. Made from 1/4" alloy aluminum plate, the Micro Rigging Plate is both strong and lightweight. Ideal for Search and Rescue, Climbing, and Litter Bridles.

Strength: 8,094 lbf (36 kN) WLL: 800 lbs (364 kg) Length: 3.5" (87.5mm) Width: 3.25" (81mm) Hole Size: 3/4" (19mm) Weight: 2.4 oz. (68.2 gm) Rating: General Use

603214

Micro Rigging Plate



STAINLESS STEEL RIGGING PLATE

Heavy Duty / Lightweight

Designed to compliment your existing rigging equipment. Lightweight, strong and effective. Allows rigging team to set up more efficient anchor systems. Prevents carabiners from jamming together. Machined from stainless steel.

Strength: 13,000 lbf. (57.8 kN) WLL: 1,300 lbs. (590 kg)
 Dimensions: 5 x 5" (125 x 125mm) Weight: 12 oz. (68.2 gm)
 Rating: General Use

603211

Stainless Steel



RIGGING RINGS

Traditional forged rings to be used as rigging rings, connection points for rigging a stretcher, and many other uses. Drop forged alloy steel.

Inside Diameter: 3 inches Rating: General Use.

		Strength	Weight
603230	1/2" Ring	10,000 lbf.	10.4 oz.
603240	9/16" Ring	40,000 lbf.	12 oz.



FORGED ANCHORAGE CONNECTOR I

With Threaded Stud

Drop forged alloy steel. Meets or exceeds ANSI Z359.1 and CSA Z259.12-00. Complete with grade 9 nut and lock washer.

Recommended torque value: 45 - 55 ft-lbs. Bolt diameter: 1/2"

603105

Anchor Connector I



ROCK EXOTICA ROCKSTAR RIGGING POINT

A new generation of rigging plate. Triangular shaped and allows you to position in three dimensions

Weight: 7.4 oz (209 gm) Height/Width: 3.7" x 3.0" x 2.6" (93 x 75 x 65 mm) Breaking Strength: 8093 lbf. (36 kN)

Certification: CE

243818220

Rockstar 3D RigPlate

Color
Red





Actuated Girder Grip ready for insertion

ISC GIRDER GRIP

For Steel Work

Anchor designed to provide secure anchor points through steel structure. Fits hole size: 19 - 28mm. Manufactured of high tensile strength steel and aluminum.

Minimum strength: 6,000 lbf. Weight: 20 oz.



603110

Girder Grip



48" STEEL PICKET



Based on the design of our TRC Super Duty pickets, these 48" long pickets feature the spool-shaped top end. Made from 1" cold rolled steel.

Picket Length: 48" Picket Weight: 10.85 lbs. each

603205

48" Steel Picket



Set includes 2 TRC Pickets and 1 Windlass

TRC SUPER DUTY PICKET SET



Designed to give the strongest picket placement. Features 10" x 7.25" rigging fins that stabilize the pickets with more lateral surface area than standard round pickets. Each picket has 8 holes (.75" dia.) to aid in system rigging. Multiple rigging options. Made from 1" cold rolled steel. Includes 2 TRC Pickets and 1 Windlass (.75" diameter) Optional padded storage bag.

Picket Length: 48" Picket Weight: 16 lbs. each Windlass Length: 36" Weight: 4.6 lbs.

603204

TRC Picket Set

603202

Picket Storage Pack



INSTANT HITCH ANCHOR

Fits Vehicle Receiver Hitch



A simple solution to a basic problem. How do you use your vehicle as an effective anchor? The IA does this by transforming a receiver hitch into a multi-point technical rescue anchor. Durable steel construction with electrostatic powder painted finish.

Strength: 8,993 lbf. (40 kN) WLL: 900 lbs. (409 kg) Dimensions: 13.25 x 8.5" (331 x 213mm) Weight: 8.1 lbs. Rating: General Use

Must be used with a properly, professionally installed Class III receiver hitch with appropriate hitch pin (not included) installed and secured.

603415

Instant Hitch Anchor

603418

Padded Case, Instant Anchor



BEAM CLAMP

Designed as a high strength portable rigging point for both horizontal and vertical I-Beam structures. The turnbuckle type threaded mechanism allows quick attachment to 3" - 9" flange widths. Every unit is tested and certified before shipment.

WLL, Personnel: 2,000 lbs. (909 kg) Weight: 11.3 lbs. (5.1 kg) WLL, Equipment: 4,000 lbs. (1818 kg) Rating: General Use

603412

Heavy Duty Beam Clamp



SNOW/SAND PICKET



Custom "Anchor" shaped structural aluminum alloy pickets in two lengths. Multiple rigging holes for ease of use. No sharp edges. Powder coated for durable good looks.

603136

36" Picket

ARBORIST EQUIPMENT



FORGED RIGGING BLOCKS

ISC Rigging Blocks have color-coded sideplates and pulley wheels, helping the user to easily identify the correct Block for the task.

Small - Working line diameter: 1/2" (13mm) Topping Strop Diameter: 3/4" (19mm) Material, Body: Aluminum Material, Wheel: Aluminum. Weight: 3.5 lbs (1.6 kg) Powder Coated.

Medium - Working line diameter: 3/4" (19mm) Topping Strop Diameter: 1 1/8" (29mm) Material, Body: Aluminum Material, Wheel: Aluminum. Weight: 5.1 lbs (2.3 kg) Powder Coated. 2014180572 Medium MBS: 44,962 lbf (200 kN) WLL: 8,800 lbs (4000 kg) Working line diameter: 3/4" (19mm) Topping Strop Diameter: 1 1/8" (29mm) Material, Body: Aluminum Material, Wheel: Aluminum. Weight: 5.3 lbs (2.5 kg) Powder Coated.

	Size	Color	Weight	MBS	WLL
2014180504	S	Aluminum	3.5 lbs	22,480 lbf	4,400 lbs
2014180556	M	Aluminum	5.3 lbs	44,962 lbf	6,600 lbs



ISC CAST RIGGING BLOCK

A lightweight version of ISC's venerable Cast Rigging Blocks. At approximately half the size of the small cast pulley, the compact rigging pulley offers an impressive strength to weight ratio. Fitted with a spring-lock mechanism for quick, easy opening/closing and a secure lock while in use.

Working line diameter: 1/2" (13mm) Topping Strop Diameter: 5/8" (16mm) Material Body: Forged Aluminum Material, Wheel: Aluminum Weight: 1 lb (490 gm)

	Color	Weight	MBS	WLL
2014180572	Aluminum	1 lb	49,900 lbf.	8,800 lbs



TIMBER™

Full Function Arborist Seat Harness

Adjustable sliding D-ring enables you to take safe, comfortable and effective work position. Wide padding provides superior comfort. Side D-rings for work positioning or gear attachment. 4 gear loops.

Weight: 64.8 oz. (Med/Lg)



	Size	Waist
238900123	Med/Large	30" - 39"
238900125	XLarge	34" - 44"



ISC STRYDER FOOT ASCENDER

Durability and functionality were at the top of the list during the development of the STRYDER. By utilizing established ascender geometry, the STRYDER provides smooth upward movement and positive rope engagement. Fully adjustable on both the horizontal and vertical straps. Protective under-foot sleeve is made from a product specific webbing. Using the same unique stainless steel cam as the PRO ascender, the cone-shaped cam face grabs the rope with minimal wear. A removable foot lever can be used to open/close the cam with the other foot.

Fits ropes 5/16" - 1/2" (8-13mm) Dimensions: 3" x 2" x 1" (75 x 52 x 25mm) Weight: 7 oz (198 gm)

	Description	Weight	MBS	WLL
2014182274	Right	7 oz.	562 lbf	308 lbs
2014182275	Left	7 oz.	562 lbf	308 lbs



ISC DEADWEIGHT TROLLEY

A new anchor point for use behind structural handrails, balustrades & parapet walls (Requires minimum 24 inch wall height). Ideal for confined working spaces -requires working area of only 16" x 20". Static load tested for two-man rescue. Includes Trolley and six 55 lb weights. Manufactured of powder coated steel.

Color: Yellow. WLL: 550 lbs (250 kg) CE Approved to BSEN 795:1997

201403100



ISC A-FRAME DEADWEIGHT ANCHOR

For use behind Structural Handrails, Balustrades & Parapet walls. Suitable for use on flat roof surface (Requires minimum 12" wall). Provides 5'9" (1.8m) high anchor points that enables user to easily start their descents. Special tires prevent damage to Surfaces. Does not require penetration of roof membrane. The ISC A-Frame features a unique, built-in shock absorber to reduce dynamic forces. Unit can easily be moved sideways reducing the need for re-rigging. Minimal assembly required. Includes 12 x 55 lb Weights.

WLL: 550 lbs (250 kg). Meets EN795:97 Type B.

201403200



ISC ROPE GRAB, FIXED AXLE

A modified version of the original ISC Rope grab. This version replaces the Pip pins with a fixed cam axle.

Fits ropes: 3/8" - 1/2" Weight: 6 oz. (177 gm)

201418203



WARNING

Technical rescue and safety is potentially hazardous. Any person using equipment sold by RESCUE TECHNOLOGY in any manner is personally responsible for learning the proper techniques involved, and assumes all risks and accepts full and complete responsibility for any and all damages or injury of any kind, including death, which may result from the use of any RESCUE TECHNOLOGY equipment

RESCUETECH KITS

EVERYTHING YOU NEED

RescueTECH offers a great selection of Rescue Kits and Rescue Equipment Sets for Technical Rope Rescue. High Angle Rescue, Confined Space Rescue, Tower Rescue, First Responder Rope Rescue and First Responder Water Rescue. All of our kits are made with the most current model of the components. As such, many kits are made-to-order and may require a couple of days to assemble.

TECHNICAL RESCUE TEAM SET

The minimum team equipment required to handle most high or low-angle rope rescue responses. Sufficient for rescues that require both raising and lowering of a patient.

- Rescue Stretcher, S.S. (1) • Deluxe Rescue Etrier (1) • Stretcher Patient Harness (1) • Quick-Fit Lashing Kit (1) • Adjustable Bridle Kit (1) • Stretcher Equipment Pack (1) • Rope Bag (2) • Duffle Bag, XL (1) • Equipment Cache (1) • Anchor Sling w/ 'D', 6 ft. (2) • Anchor Sling w/ 'D', 8 ft. (2) • Transfer Sling (1) • Load Release Strap (2) • 8mm Prusik x 5 ft. (6) • 8mm Prusik x 6 ft. (1) • 1/2 in. Rescue Ascender (2) • 2.5 PMP Rescue Pulley (5) • RescueTECH Edge Roller, Double (1) • Rope Pad, Wide (1) • 1 in. Yellow HD Web, 12 ft. (2) • 1 in. Orange HD Web, 20 ft. (2) • Rigging Plate (1) • Delta Link (4) • NFPA Offset 'D' Carabiner (1) • NFPA 'D' Screwgate (3) • Rescue Rappel Rack (1) • RD70 Rescue Carabiner (15) • Rope Guard, Red (4) • 1/2 inch. Access Lifeline x 150 ft. (2)

Items shown for illustration purposes - Not to Scale. Items subject to change if new/improved components become available.



29982012

Technical Rescue Team Set

RAISE / LOWER SET

- Equipment Saddle Bag (1) • NFPA Rescue Rope (1) • Anchor Sling w/ D, 10 ft. (2) • 8mm Cord x 5 ft. (2) • 8mm Cord x 6 ft. (1) • Rescue Rappel Rack (1) • Rope Bag (1) • Rigging Plate (1) • PMP Rescue Pulley (2) • RD70 Rescue Carabiner (5) • Dogbone Rigging Sling (1)

Items shown for illustration purposes - Not to Scale. Items subject to change if new/improved components become available. *Meets NFPA 1983/ANSI/OSHA strength specifications.



29982120
29982130

Length
200'
300'

2 RESCUER CONFINED SPACE STANDBY SET

The set is the minimum set of equipment needed to start a standby team and access the patient. Includes harness and personal safety equipment for 2 rescuers. • **Vanguard II Full Body Harness (2)** • **Vertex 2 Vent helmets (2)** • **Rope & Equipment Bags (2)** • **1/2 in. Access Lifeline x 150 ft. (2)** • **EOS Headlamp (2)** • **2.5 PMP Rescue Pulley (4)** • **Rescuer Gear Bag (2)** • **Presewn Prusik Sling 20" (2)** • **Presewn Prusik Sling 30" (2)** • **Pro Leather Gloves (2)** • **RescueTECH Load Release Strap (2)** • **OD50 Rescue Carabiner (10)** • **NFPA 'D' Screwgate (2)**

Items shown for illustration purposes - Not to Scale. Items subject to change if new/improved components become available.



29981001

2 Rescuer Confined Space Standby Set

USAR PACK RESCUE SET

An equipment set designed to provide equipment for basic rigging, access, and rescue. • **USAR Rope & Equipment Pack (1)** • **1/2 in. NFPA Rope (1)** • **NFPA Rescue 8 Descender (1)** • **RD70 Rescue Carabiner (8)** • **RescueTECH Anchor Sling, 8 ft. (2)** • **2.5 PMP Rescue Pulley (2)** • **Gibbs Ascender, Free Running (2)** • **1/2 in. Rescue Ascender (1)** • **Rescue Rappel Rack (1)** • **Anchor Sling w/ D, 6 ft. (2)** • **2 in. RescueTECH PMP Bushing Pulley (1)** • **Rope Guard, 18 in. (2)**

Items shown for illustration purposes - Not to Scale. Items subject to change if new/improved components become available.

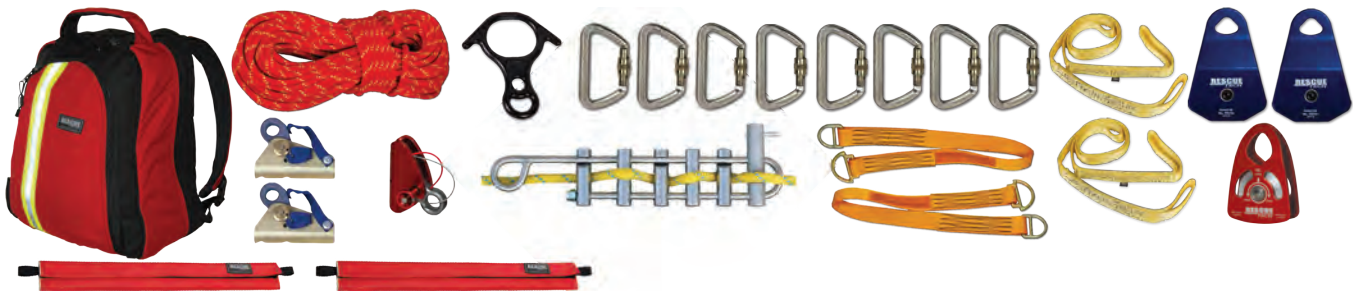

	Length	Color		Length	Color
350526	150'	Blue	350536	200'	Blue
350524	150'	Red	350534	200'	Red



Technical rescue and safety is potentially hazardous. Any person using equipment sold by RESCUE TECHNOLOGY in any manner is personally responsible for learning the proper techniques involved, and assumes all risks and accepts full and complete responsibility for any and all damages or injury of any kind, including death, which may result from the use of any RESCUE TECHNOLOGY equipment.

ROPE ACCESS TECHNICIAN EQUIPMENT SET

A simple set of personal equipment for basic Rope Access work.

- Advantage Full body Harness (1) • Vertex 2 Vent Helmet (Red) (1) • 10mm Delta Rapid Link (1) • ISC D4 (1) • Micro Strap Pulley (1) • Adjustable Foot Sling (2) • ISC RED Backup Device (2) • T2 Rescue Pack (1) • Chest Ascender (1) • Pro Leather Glove (Tan) (1 pair) • "I" Lanyard, 24" (1) • "I" Lanyard, 32" (1) • Handled Ascender (1) • Aluminum Offset D Carabiner (10) • 6mm Connector Link (2) • Chest Harness Ascender loop (1)

Items shown for illustration purposes - Not to Scale. Items subject to change if new/improved components become available.



29982013

TECHNICAL RESCUE TEAM MEMBER SET

The basic starter set for most team members.

- Vanguard II Full Body Harness (1) • Vertex 2 Vent (1) • Pro Leather Gloves (Black) (1 pair) • Prusik Sling, 30 in. (Red) (1) • Prusik Sling, 20 in. (Yellow) (1) • Daisy Chain, 36 in. (Red) (1) • Technical Rescue, Rope I & II (1) • Personal Gear Bag (BK/RD) (1) • Harness Equipment Pouch (1) • Striketeam XTO Goggles (1) • EOS Headlamp (1) • Rescue 8 (1) • OD50 Rescue Carabiner (3)

Items shown for illustration purposes - Not to Scale. Items subject to change if new/improved components become available.



29981011

Team Member Kit

BASIC FIRST RESPONDER TEAM SET

The basic starter set for most team members.

- Prime Full Body Harness (2) • Vertex 2 Vent Helmet (2) • 12mm Delta Rapid Link (1) • Rescue 8 Descender (2) • Anchor Sling w/ 'D' (1) • Access Lifeline, 1/2 in. x 200 ft. (1) • H.D. Gear/Equipment Bag (1) • Rope Bag (1) • OD50 Rescue Carabiner (5) • Pro Leather Glove (2 pair)

Items shown for illustration purposes - Not to Scale. Items subject to change if new/improved components become available.



29981002

First Responder Set



BRIDGEPORT FIREFIGHTER RESCUE SET

The Bridgeport Firefighter Rescue set was developed in the field and in training exercises for a prominent N.E. fire dept. The equipment set includes sufficient equipment for firefighter rescue – both at height and below grade. The set allows firefighters to set up a mechanical advantage system to easily extract / lower a downed firefighter. • **Rope Bag (1)** • **Iron Wizard Ladder Hook, T/L (1)** • **3" Single Rescue Pulley (1)** • **2" Single Rescue Pulley (1)** • **Recovery Hook (1)** • **½" ACCESS Lifeline-Lime Green (60)** • **1" H.D. Flat Webbing-Yellow (25')**

WLL: 550 lbs (250 kg). Meets EN795:97 Type B.

29986001

Z-RIG HAUL SET

RescueTECH equipment packaged in a ready-to-rig 3:1 Z-Rig system. • **Rope Bag (1)** • **Anchor Sling w/ D (6') (1)** • **2.5 PMP Rescue Pulley (2)** • **OD50 NFPA Rescue Carabiner (3)** • **Blue HD Web, 15 ft. (1)** • **Delta Rapid Link (1)** • **1/2 in. Rescue Ascender (1)** • **8mm Cord x 5 ft. (1)** • **8mm Cord x 6 ft. (1)** • **1/2 in. NFPA Rope x 200 ft. (1)**

Items shown for illustration purposes - Not to Scale. Items subject to change if new/improved components become available.



29984151150
29984151200

Length
150'
200'

GF-USAR RESCUE PACK SET

RescueTECH equipment packaged in a ready-to-rig 3:1 Z-Rig system. • **Rope Bag (1)** • **8mm Cord x 6 ft. (4)** • **1/2" Rescue Ascender (1)** • **Delta Rapid Link (2)** • **Rescue Rappel Rack (1)** • **8mm Cord x 5 ft. (4)** • **1 in. Green HD Web, 5 ft. (2)** • **1 in. Yellow HD Web, 12 ft. (2)** • **1 in. Orange HD Web, 20 ft. (2)** • **1 in. Blue HD Web, 15 ft. (1)** • **OD50 Rescue Carabiner (10)** • **NFPA Rescue 8 Descender (1)** • **540 Belay Device (1)** • **XL Rescue 'D' Carabiner (1)**

Items shown for illustration purposes - Not to Scale. Items subject to change if new/improved components become available.



91231001

CONFINED SPACE RESCUE SET

Designed to provide a 2-person team with a set of equipment that allows for the rescue of victims. Comes complete with Tripod and Extractor CSR Kit for an anchor point and retrieval system. A separate belay may be set up with the included Petzl I'd Belay device and 150 ft. section of 1/2" ACCESS Lifeline. Rigging equipment and edge protection is also included. All personal and team equipment, as well as hardware and tripod storage is included. • **EOS Headlamp (2)** • **Vertex Vent Helmets (2)** • **Pro Leather Glove (pair) (2)** • **Vanguard II Rescue Harness (2)** • **Technician Tripod w/ Tripod Bag (1)** • **Petzl I'D Belay Device (1)** • **1/2" ACCESS Lifeline x 150 ft. (Blue) (1)** • **Technical Rescue Rigging Plate (1)** • **OD50 Steel Carabiners, Screwgate (10)** • **RescueTECH PMP, Bushing (1)** • **1/2" Extractor CSR Kit w/ Bag, 150 ft. (1)** • **Rigging Sling w/ D, 8 ft. (2)** • **Load Release Sling (1)** • **11mm Aluminum Carabiner, Screwgate (1)** • **Remote Retrieval Hook (1)** • **Extractor Pole, 12' (1)** • **RescueTECH Edge Pad, Wide (1)** • **RescueTECH Rope Guard, 24" (Red) (2)** • **RescueTECH Rope Bag, Medium (Blue) (1)** • **RescueTECH Deluxe Equipment Pack (Blue) (1)** • **RescueTECH Duffle Bag, Large (Blue) (2)**

Items shown for illustration purposes - Not to Scale. Items subject to change if new/improved components become available.



2998123

Confined Space Rescue Set

SPIN-LOCK RESCUE / RETRIEVAL SYSTEM

Locking Pulley for Combination Raise / Lower System

The Spin-Lock Rescue system is a pre-rigged 4:1 Hauling system that utilizes a unique pulley with sheaves that rotate in only one direction. When properly rigged, this system works as an efficient 4:1 mechanical advantage pulley system that also provides friction to control the load when in lowering mode. The special sheave are mounted on a unique one-way bearing that allows the user to easily control a rescue load. Also, included is a Handled Ascender to control and anchor the system when at rest. The attached foot loop also aids the rescue in raising heavier loads. The Spin-Lock Rescue / Retrieval Kit is a pre-rigged kit that combines the RescueTECH Remote Retrieval Hook and Extension Pole access system with a Spin-Lock Rescue / Retrieval system. The remote hook and extension pole allows for non-entry remote attachment of a rescue lifeline to a victim in a confined space or vertical environment.



Remote Retrieval Hook and Extension Pole included in Kit ONLY

Item Description/Length	Item Description/Length
29984401 Spin-Lock System / 50'	29984421 Spin-Lock Kit / 50'
29984402 Spin-Lock System / 75'	29984422 Spin-Lock Kit / 75'
29984403 Spin-Lock System / 150'	29984423 Spin-Lock Kit / 150'

HAULERBINE TOWER RESCUE SYSTEM

We have updated our original version of the Tower Rescue System by adding more advanced and easier to use components. First we replaced the Mini Haul with a HaulerBiner system. The HaulerBiner is a compact 6:1 / 7:1 mini haul that features an integral cam-lok. By putting the pulley sheaves onto a carabiner body, the unit is more compact than a traditional mini-haul system. The mesh sheath keeps the purpose-made 6mm cord from tangling. Total Adjustment length: 48". Second, we changed out the Anthron squeeze-type belay device for a D-4 belay device with panic lock. The D-4 offers superior control of the load without requiring too much hand strength. Our Tower Rescue Pack keeps the rescue system separate from the main rope. Available in 200' and 300'. • **Rope Bag (1)** • **Anchor Sling w/ D (6') (1)** • **2.5 PMP Rescue Pulley (2)** • **OD50 NFPA Rescue Carabiner (3)** • **Blue HD Web, 15 ft. (1)** • **Delta Rapid Link (1)** • **1/2 in. Rescue Ascender (1)** • **8mm Cord x 5 ft. (1)** • **8mm Cord x 6 ft. (1)** • **1/2 in. NFPA Rope x 200 ft. (1)**

Items shown for illustration purposes - Not to Scale. Items subject to change if new/improved components become available.

	Length
29982160-200	200'
29982160-300	300'



TOWER RESCUE SYSTEM II

A Rescue Technology original. Specially designed pack protects contents and allows a rescuer to comfortably carry the pack up to the point of rescue. Packaged in a RescueTECH T2 Rescue Pack. The system is comprised of a load transfer system that allows the rescuer to move the patient onto the rescue system without having to cut away existing fall restraint. The load is then lowered using Anthron Lowering device. Features Certified NFPA 3/8" Rescue rope.

• **3/8" ACCESS Lifeline x 300 ft. (1)** • **RescueTECH Rigging Sling, 4 ft. (1)** • **CSR Load Transfer System (1)** • **Anthron Lowering Device (1)** • **T2 Rescue pack (1)** • **AutoLocking Carabiners (3)**

	Rope Length
29982154	200'
29982156	300'

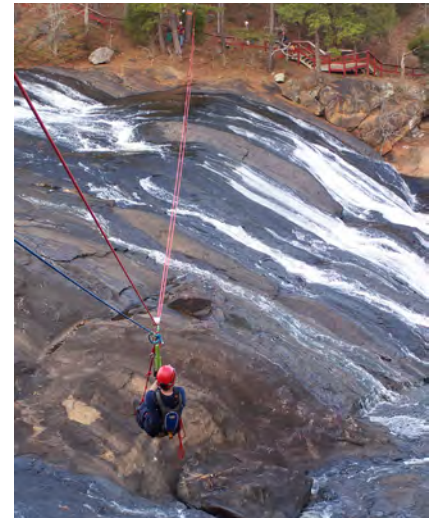

Technical rescue and safety is potentially hazardous. Any person using equipment sold by RESCUE TECHNOLOGY in any manner is personally responsible for learning the proper techniques involved, and assumes all risks and accepts full and complete responsibility for any and all damages or injury of any kind, including death, which may result from the use of any RESCUE TECHNOLOGY equipment

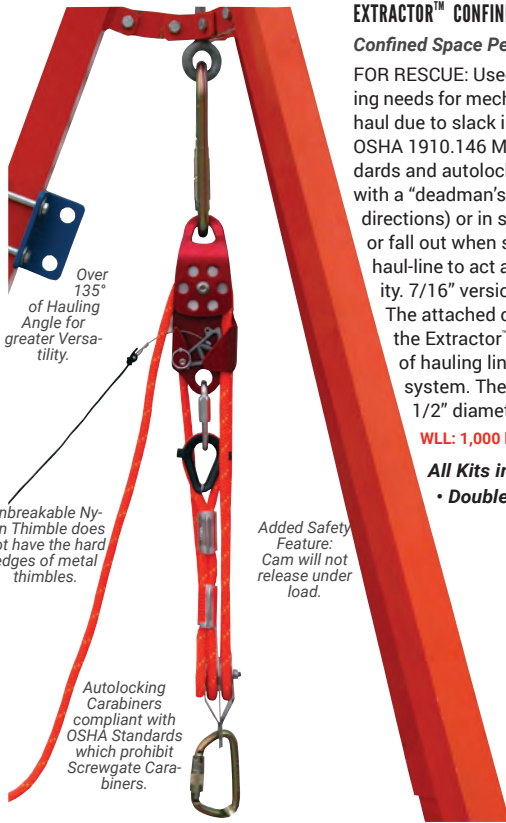

RT Extractor show with H.D. Tripod (not included with kit)

EXTRACTOR™ CONFINED SPACE RESCUE KIT

Confined Space Personnel Rescue Kit

FOR RESCUE: Used as 4:1 Block and Tackle or “piggy-backed” onto main haul line. Decreases training needs for mechanical advantage systems. Great re-direct pulley with a built-in safety. No loss of haul due to slack in a prusik cord or external camming safety. **FOR INDUSTRY:** Easy to use. Meets OSHA 1910.146 Mechanical Retrieval Device standard. Meets ANSI Z359.1 vertical lifeline standards and autolocking carabiner requirements. **LIFTING SAFETY:** Unit works as a hauling system with a “deadman’s” safety. Included safety pin holds cam in either open (rope will run freely in both directions) or in safety position. Rope will move in hauling direction only and cannot be removed or fall out when safety is engaged. Extractor™ may be used horizontally and can be attached to a haul-line to act as a 4:1 hauling system. 1/2” version available in 37 ft., 50 ft. and 66 ft. lift capacity. 7/16” version available in 50 ft. and 100 ft. lift capacity. **REMOTE LOWERING CAPABILITY:** The attached cable allows remote control of the safety cam. This makes it possible to place the Extractor™ unit where it cannot be directly accessed. Extractor™ design provides over 135° of hauling line movement. It does not limit hauling team to standing “in-line” with the rope system. The pulley sheaves are equipped with Oilite™ bushings and will accept ropes up to 1/2” diameter. The Extractor™ frame is constructed of high tensile aluminum alloy.

WLL: 1,000 lbs. EXTRACTOR Pulley Dimensions: 9” x 3” Color: Red

All Kits include: • ACCESS Lifeline w/ sewn eye (1) • EXTRACTOR™ CSR Pulley (1) • Double or Single Pulley (1) • Autolocking Carabiners (1) • Rope and Equipment Bag (1)

1/2” EXTRACTOR™ CSR KIT

With Rope / Equipment Bag

614481200xx	4:1 Extractor x 200'
614481150xx	4:1 Extractor x 150'
614482200xx	4:1 Extractor Swivel x 200'
614482150xx	4:1 Extractor Swivel x 150'
614381200xx	3:1 Extractor x 200'
614381150xx	3:1 Extractor x 150'

Swivel Kits complete with lower swivel pulley.



7/16” EXTRACTOR™ CSR KIT

With Rope / Equipment Bag

614471200xx	4:1 Extractor Kit x 200'
614472200xx	4:1 Extractor Swivel x 200'
614371200xx	3:1 Extractor Kit x 200'
614371300xx	3:1 Extractor Kit x 300'

4:1 / 5:1 EXTRACTOR™ LOAD TRANSFER KIT

This kit is a mechanical advantage system that allows the user to safely transfer a load. It provides the security of a built-in safety cam. 4:1 Kit complete with 40 feet of rope for 10' of lift. Available with Autolocking or Screwgate carabiners. Complete with storage bag.

Meets NFPA 1983/ANSI/OSHA strength requirements.

	Length
614422	Autolock
614425	Screwgate

4:1 HAULING KIT

Block and Tackle System

Complete hauling kits that are ready to use. Each kit contains 1/2” Rescue rope & prusik cord, high strength pulleys, Gibbs Ascenders and RescueTECH Carabiners complete the system. 4:1 Block and Tackle pulley system is packaged in Rope and Equipment Bag, and is ready for the rescuer to simply reach in and grab the carabiner to attach to the rigging point.

Meets NFPA 1983/ANSI/OSHA strength specifications.

	Length
610604	150'
610624	200'



Extractor Kit with Bag.





The HaulerBiner can be used in a number of ways:

- As part of a pick-off system
- On a structure, pull down on the system and achieve a 6:1 (theoretical) MA
- When suspended in a harness, pull up on the system and achieve a 7:1 (theoretical)
- As a tensioning system for short/low load lines
- As a stretcher management device, using two or more HaulerBiners to easily change or adjust the orientation of the stretcher
- The HaulerBiner is load rated to 140kg (310lbs) but it has an MBS of at least 16kN/3500lbs tested as a complete system. Light Use

ISC HAULERBINER

With RescueTECH Rappel/Rescue Rack

The HaulerBiner has three pulley wheels incorporated into each Karabiner, creating a compact and lightweight 6:1 or 7:1 Mechanical Advantage system. The HaulerBiner also has a purpose-designed progress capture cam with an 'on/off' position. The HaulerBiner utilizes purpose-developed 6mm (1/4") rope, for strength and easy handling/best grip. The kit is supplied in a two-pouch bag, for easy deployment. The HaulerBiner is load rated to 140kg (310lbs) but it has an MBS of at least 16kN/3500lbs when tested as a complete system. Kits are available in three standard lengths; 105cm (41"), 165cm (65") or 300cm (118"), with custom lengths available on request. The length of the system, when fully contracted is only 32cm (12")!

- VANGUARD II Rescue Harness (1) • R5SL Rescue Helmet (1) • Pixa2 Headlamp (1) • Knee Pads (1 pair) • Uniform Emergency Belt (1) • Presewn Prusik Sling, 20" (1) • Presewn Prusik Sling, 30" (1) • Rescue/Rappel Rack (1) • Cyalume Lightstick (White) (3) • Pro Leather gloves (1) • Glove Cinch (1) • 1 in. Orange HD Web, 20 ft. (1) • Technical Rescue Field Guide (1) • 1/2" Access Lifeline (10') (1) • Zorber Shock Absorber (1) • Transfer Sling (1) • Adjustable Rigging Sling (1) • RD70™ Rescue Carabiners (5) • Rescue Gear Bag (1)

Items shown for illustration purposes - Not to Scale. Items subject to change if new/improved components become available.

201408105	41" (105 cm)
201408165	65" (165 cm)
201408300	118" (300 cm)

DELUXE TEAM MEMBER SET

With RescueTECH Rappel/Rescue Rack

- VANGUARD II Rescue Harness (1) • R5SL Rescue Helmet (1) • Pixa2 Headlamp (1) • Knee Pads (1 pair) • Uniform Emergency Belt (1) • Presewn Prusik Sling, 20" (1) • Presewn Prusik Sling, 30" (1) • Rescue/Rappel Rack (1) • Cyalume Lightstick (White) (3) • Pro Leather gloves (1) • Glove Cinch (1) • 1 in. Orange HD Web, 20 ft. (1) • Technical Rescue Field Guide (1) • 1/2" Access Lifeline (10') (1) • Zorber Shock Absorber (1) • Transfer Sling (1) • Adjustable Rigging Sling (1) • RD70™ Rescue Carabiners (5) • Rescue Gear Bag (1)

Items shown for illustration purposes - Not to Scale. Items subject to change if new/improved components become available.



29982191



DELUXE MEMBER SET - D5

With with Petzl I'd

Same item list as 2998291 but with the substitution of a Petzl I'd for the rack descender.

- VANGUARD II Rescue Harness (1) • R5SL NPFA Helmet (1) • Pixa 2 Headlamp (1) • Knee Pads, Pair (1) • RescueTECH Uniform Belt (1) • Presewn Prusik Sling 30" (1) • Presewn Prusik Sling 20" (1) • RD70™ Rescue Carabiners (5) • Pro Leather gloves (1) • Glove Cinch (1) • ISC D5 (1) • Technical Rescue Field Guide (1) • Rescuer Gear Bag (1) • Shock Absorber (1) • Transfer Sling (1) • Adjustable Rigging Sling (1) • 1 in. Orange HD Web, 20 ft. (1)

Items shown for illustration purposes - Not to Scale. Items subject to change if new/improved components become available.

29982197

Deluxe Team Member Set - D5

DELUXE TEAM MEMBER SET I'D

With with Petzl I'd

Same item list as 2998291 but with the substitution of a Petzl I'd for the rack descender.

- VANGUARD II Rescue Harness (1) • R5SL NPFA Helmet (1) • Pixa 2 Headlamp (1) • Knee Pads, Pair (1) • RescueTECH Uniform Belt (1) • Presewn Prusik Sling 30" (1) • Presewn Prusik Sling 20" (1) • RD70™ Rescue Carabiners (5) • Pro Leather gloves (1) • Glove Cinch (1) • Petzl I'D (1) • Technical Rescue Field Guide (1) • Rescuer Gear Bag (1) • Shock Absorber (1) • Transfer Sling (1) • Adjustable Rigging Sling (1) • 1 in. Orange HD Web, 20 ft. (1)

Items shown for illustration purposes - Not to Scale. Items subject to change if new/improved components become available.



29982192

Deluxe Team Member Set I'D

USAR PACK DELUXE RESCUE SET

An equipment set designed to provide equipment for basic rigging, access, and rescue. • 1/2" NFPA Rope x 200 ft. (1) • RescueTECH Large D Carabiner (12) • Gibbs Ascender, Free Running (2) • 1/2" Rescue Ascender (2) • NFPA Rescue 8 Descender (1) • Rescue Rack (1) • Anchor Sling w/ D, 6 foot (4) • 2.5 PMP Rescue Pulley (4) • 1 2.5" Double PMP Rescue Pulley (1) • 2 Rope Guard, 18" (2) • Delta Rapid Link (1) • Technical Rescue Rigging Plate (1) • 10" Steel Cable Sling (1) • Red HD Web, 25 ft. (2) • Orange HD Web, 20 ft. (2) • Blue HD Web, 15 ft. (2) • Yellow HD Web, 12 ft. (2) • Green HD Web, 5 ft. (2) • 8mm Prusik Cord, Long (4) • 8mm Prusik Cord, Short (4) • USAR Pack (1)
 Items shown for illustration purposes - Not to Scale. Items subject to change if new/improved components become available.



	Color
350566	Blue
350564	Red

DELUXE EQUIPMENT PACK SET

A set of equipment designed to meet the basic needs of rescuers. Use this set of equipment with two life safety ropes and create a raise / lower system with belay system. Multiple mechanical advantage systems can be built as well as specialized rigging systems. • Deluxe Equipment Pack (1) • 8mm Prusik x 6' (2) • Rescue Rappel Rack (1) • Aluminum D, S/G (1) • Delta Rapid Link (1) • RD70 Carabiner, S/G (10) • 2.5" Single PMP (3) • 2.5" Double PMP (3) • Rope Guard, 18" (2) • Anchor Sling, 8' (2) • Anchor Sling w/ D, 6' (2) • 1" H.D. Web x 20' (2) • 1" H.D. Web x 25' (1) • Load Release Strap (1)
 Items shown for illustration purposes - Not to Scale. Items subject to change if new/improved components become available.

Items shown for illustration purposes - Not to Scale. Items subject to change if new/improved components become available.



29983420

Deluxe Equipment Pack



PERSONAL CSR / TRANSFER KIT

Built-In Safety Cam

Great tool for rescuers transferring the victims load to a new rescue line. Can be used as either a 4:1 or 5:1 system. Works like a "power-assist" pick-off strap. Utilizes the Micro CSR Pulley for hauling safety. Complete with storage pouch that will attach to rescue harness.

WLL: 600 lbs. Weight (48" version): 41.6 oz.

614433	Autolock, 48" Lift
614436	Screwgate, 48" Lift
614433-10	Autolock, 10 ft. Lift
614436-10	Screwgate, 10 ft. Lift



MINI-HAUL - LIGHT

Includes Storage Bag

A mini 4:1 / 5:1 Hauling system for those time when you don't need to deploy your long ropes and heavy pulleys. Perfect for litter attendants, edge transitions, and much more. Comprised of our 7/16" ACCESS Lifeline (30'), RescueTECH Double Mini Pulley (2), OD50 Carabiners (2), Prusik Cord, and pouch (will attach to harness).

Tested Strength to Prusik failure: 5,500 lbf. Ultimate Strength: 7,000 lbf. Light Use. WLL: 600 lbs.

614405	Screwgate
614406	Autolock



MINI-HAUL - GENERAL

Includes Storage Bag

A full-sized 4:1 / 5:1 Hauling System for all types of rescues. Perfect for load transfer, short haul distances, pre-rigs, and much more. Comprised of our 1/2" ACCESS Lifeline (30'), RescueTECH Double PMP (2), OD50 Carabiners (2), Prusik Cord, and pouch (will attach to harness).

Ultimate Strength: 9,000 lbf. General Use. WLL: 600 lbs.

614412	Screwgate
614413	Autolock



R-ALF 5:1

R-ALF 3:1



R-ALF RESCUE KIT

The R-ALF Pulley is the latest innovation in Rescue, Confined Space working and Work Suspension Systems. The R-ALF Pulley has an over-speed brake built in so that the Pulley will lock and hold when a fall occurs. The load rated Becket Eye on the R-ALF means that it can be used in combination with Prusik Pulleys to create a 3:1 or 5:1 Mechanical Advantage System. The unique design of the R-ALF (design patent applied for), means that an external brake is not required and therefore it is capable of several thousand cycles and many arrests (minimum 12 mostly service intervals apply). Kits are complete with rope for a 33 ft. (10m) lift.



29984313150	3:1 R-ALF Kit
29984315200	5:1 R-ALF Kit

SLINGS & LANYARDS SUPERIOR WEBBING

RescueTECH Slings and Lanyards outperform the competition

RescueTECH webbing and rope slings are engineered to be stronger and outwear similar brands of straps. We have chosen higher strength webbing that gives better performance and adds to the trust that you can have in your systems. From our Heavy Duty Anchor slings that use a 10,000 lbf webbing with wear indicators to our Super Duty Anchor Slings, you can trust RescueTECH slings for all of your rescue needs.



HEAVY DUTY ANCHOR SLING

Strongest 1" Heavy Duty Double End Rigging Sling

Eliminates wasted rigging time spent tying knots in rigging lines. Made from 1" solid weave, high strength nylon webbing. The special webbing has RED tracers to indicate cuts in the webbing. Available in multiple lengths, each sling has a sewn loop at each end to provide maximum versatility. Anchor points may be wrapped single, double, triple, etc., to suit particular rescue situations. Anchor Slings exceed all standards and regulations for Light Use Life Support lines. When looped like a basket hitch, anchor slings meet General Use load requirements.

End-to-End Tensile Strength: 8,500 lbf. Color: Yellow Basket Strength: 15,000 lbf. (67 kN) WLL: 850 lbs. Loop Size: 6" Rating: General Use

	Length
7550032	3'
7550042	4'
7550052	5'
7550062	6'
7550082	8'
7550102	10'



HEAVY DUTY ANCHOR SLING W/ WIDE "D" RING

Manufactured from heavy duty TECHWeb flat webbing (Tensile Strength: 10,000 lbf.). Each sling has a standard "D" ring (proof Load: 5,000 lbf.) and a Wide "D" sewn at the ends to provide maximum versatility. Anchor points may be wrapped single, double, triple, and rigged choker-style to suit particular rescue situations. Although webbing tensile strength is high, overall tensile strength is limited by the "D" rings.

NFPA Tensile Strength (Basket): 15,760 lbf. (70.1kN) Choker Strength: 7,240 lbf. (32.2kN) Color: Yellow End-to-End Strength: 8,660 lbf. (38.5kN) Rating: General Use

	Length
75941032	3'
75941042	4'
75941052	5'
75941062	6'
75941082	8'
75941102	10'
75941152	15'



SUPER DUTY ANCHOR SLING

Strongest Webbing Slings in the Rescue Industry

Manufactured from 2" wide solid weave high strength webbing. Special RED internal tracers function as edge cut indicators that are exposed when the webbing edge is abraded, cut, or torn. Large heavy duty forged steel links on each end will allow end-to-end, basket, and choker use of the sling. Exceed all standards for two person lifeline strengths.

End-to-End Tensile Strength: 15,000 lbf Color: Yellow Basket Strength: 28,000 lbf (125 kN) WLL: 1,500 lbs. Rating: General Use

	Length
756504	4'
756506	6'
756508	8'
756510	10'



QUIK-RIG HD ANCHOR SLING

New quick-attach rigging point that eliminate off-axis loading of rigging carabiners. Simply wrap the sling around the rigging point to form a basket, then attach the Forged Eye Autolocking Steel Carabiner to the Rigging ring. Not designed for Choker attachment.

Ring Strength: 10,000 lbf. (44.5 kN)
Carabiner Strength: 10,000 lbf. (44.5 kN)
Sling Strength when rigged into Rigging Ring: 10,000 lbf. (44.5kN)

	Length
75952044	4 ft.
75952064	6 ft.
75952084	8 ft.
75952104	10 ft.



RESCUE SYSTEM CHANGE-OVER SLINGS

Great Addition To Pre-Rig Systems

Allows rescuers to extend a Z-rig past the lowering device without having to tie a "green" sling.

Super Strong: 8,500 lbf. WLL: 850 lbs.

753105	Dogbone Z-Rig Sling, 16"
7531052	Dogbone Z-Rig Sling, 21"



RESCUE SYSTEM CHANGE OVER SLING W/ "D"

Change-Over Sling w/ "D" Great Addition To Pre-Rig Systems

Allows rescuers to extend a Z-rig past the lowering device without having to tie a "green" sling.

Super Strong: 16,000 lbf. Weight: 28 oz.

753106	Super H.D. Z-Rig Sling
--------	------------------------



STEEL CABLE SLING



The highest quality life support slings made from flexible 3/8" steel cable. Manufactured with Flemish eye splices with steel swages per OSHA/ANSI standards. Each unit is tagged with date of manufacture, size, and working load in tons. Steel slings are excellent in areas of extreme high/low temperatures, chemical exposure, and abrasion.

Proof Tested: 5,400 lbf. WLL: 2,700 lbf. Rating: General Use

	Length
759304	4'
759306	6'
759310	10'
759315	15'

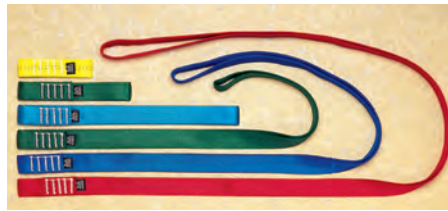

STANDARD RESCUE LOOP



High Strength Continuous Loop

High strength 1" Tubular Webbing (4,500 lbf.) provides a high strength loop. Because of the high strength and abrasion resistance of the Rescue-Spec™ Tubular webbing RescueTECH Standard Rescue Loops will outlast conventional tubular webbing slings.

End-to-End Strength: 7,400 lbf. WLL: 740 lbs. Colors: Assorted

	Length
7612012	12"
7612024	24"
7612036	36"
7612048	48"
7612060	60"



HEAVY DUTY ANCHOR LOOP



Heavy Duty Continuous Loop

Constructed of same heavy duty webbing as the Anchor Sling. This unit is sewn to form a continuous high strength rigging loop. Items are sold by linear measurement of the loop laid flat. Anchor Loops meet all standards and regulations for two-person life support lines.

End-to-End Tensile Strength: 13,000 lbf. WLL: 1,300 lbs. Color: Yellow Rating: General Use

	Length
7540042	4'
7540062	6'
7540082	8'
7540102	10'



RESCUE ANCHOR SET



We have packaged two of our Heavy Duty Anchor Straps with a Wear Guard and Delta Rapid Link to give rescuers a quick, secure, and hard wearing anchor sling set. Includes storage bag.

	Size	Length
29982101	Large	8'
29982102	Medium	6'



RESCUETECH MULTI-PURPOSE RESCUE STRAP



15' strap with forged adjuster buckle. Multiple uses: emergency harness, litter strap, rigging sling. Webbing

Strength: 6,000 lbf. Buckle Proof Load: 2,500 lbf. WLL: 600 lbs. Weight: 10 oz. Color: Black

756128	Multi-Purpose Strap
--------	---------------------



SCREAMER LOAD LIMITER



Multi-functional energy absorbing device. Exceptionally good for use in anchor point protection in any raising or lowering system. The load limiters not only absorb energy when a system is overloaded but they act as a very reliable rescue system overload indicator. The load limiters can be "ganged" to accommodate various activation forces (550, 950, 1200 lbf.).

Activation point is consistently repeatable to +/- 7%. Activation Point: 550 lbs Standard Weight: 2.4 oz.

753400	Standard Duty
--------	---------------



RESCUE SHOCK ABSORBER



This is the highly efficient webbing tear-stitch type shock absorber utilized on our lanyards. The Zorber absorbs energy by means of a controlled destruction. Two layers of webbing are woven together. Limits OSHA style loads to a maximum force of 900 lbf.

Initial Length: 10" Extended Length: 52" Minimum Tensile Strength: 6,000 lbf.

Meets all ANSI, OSHA standards and CSA construction requirements.

		Weight
A. 753420	Loop & Loop	8.8 oz.
B. 753424	Loop & Snap	15 oz.
C. 753426	Snap & D Ring	28 oz.



Includes Storage Keeper

TRANSFER SLING



Ideal for Rescue Pick-Off

Manufactured with heavy duty TECHWeb 1 3/4" flat webbing and has a forged "D" ring sewn in one end and an adjustable "V" ring on the other end. Adjusts by pulling on the hand loop. The "V" ring adjuster buckle slips at 4,500 lbf. Hardware Proof Load: 2,500 lbf.

Weight: 14.4 oz. Length: 10" - 54" Rating: General Use

756103

Transfer Sling



Includes Storage Keeper

2:1 PICK OFF STRAP



Built-in Mechanical Advantage

Used for patient pick-off situations. Configuration allows for 2:1 and 3:1 mechanical advantage for easier handling of loads. Materials: 1 3/4" Heavy Duty TECHWeb webbing with Forged D-Ring and Adjuster Buckles.

Strength: 7,000 lbf. Weight: 20 oz.

756104

2:1 Pickoff Strap



QUIK-PIK STRAP



An updated version of our 2:1 pick-off strap. We have added an aluminum autolocking snap to the patient end of the unit allowing for rapid attachment and adjustment of the unit. Strap design provides mechanical advantage and will help lift load.

Strength: 5,000 lbf. Weight: 18.4 oz.

75610434

Quik-Pik Strap



ADJUSTABLE RIGGING SLING



With Heavy Duty TECHWeb

An adjustable length rigging sling. Manufactured of heavy duty TECHWeb 1 3/4" flat webbing and has a forged "D" ring at each end. Adjusts with a slide adjuster.

Webbing Strength: 10,000 lbf. Tensile Strength: 8,000 lbf. WLL: 800 lbs. Length: Adjustable Weight: 24 oz. Color: Gold

	Length	Weight
756106	2'- 6'	24 oz.
756105	2'- 9'	29.6 oz.



Includes Locking Carabiner

HEAVY DUTY LOAD RELEASE RESCUE STRAP



The Load Release Strap uses 15,000 lbf. Large rigging "D" Rings (3" x 2.55") and a standard 1.75" forged "D" on the adjustment part. 10,000 lbf. TECHWeb is used to provide superior strength and abrasion resistance over units using type 13 webbing. Designed to prevent the adjustment end of the webbing from sliding through the rigging "D" rings. Includes Oval Steel Screwgate carabiner to secure "tail".

Weight: 23.2 oz.

7562032

HD Load Release Strap, Deluxe



LARGE RING LOAD RELEASE RIGGING STRAP



The Load Release Strap uses 15,000 lbf. Extra-large rigging "D" Rings (5" x 3.35") and a standard 1.75" forged "D" on the adjustment part. 10,000 lbf. TECHWeb is used to provide superior strength and abrasion resistance over units using type 13 webbing. Designed to prevent the adjustment end of the webbing from sliding through the rigging "D" rings.

Weight: 34.4 oz.

756202

Large Ring Load Release Strap



WEBBING LANYARDS



Manufactured from heavy duty 1" wide nylon webbing and two double locking snaps at each end. New labeling and easier to use autolocking snap.

Minimum Tensile Strength: 5,000 lbf.

Meets all ANSI, OSHA standards and CSA construction requirements.

	Length
752042	2'
752043	3'
752044	4'
752046	6'



WEBBING LANYARDS WITH LADDER HOOK



Manufactured from heavy duty 1" wide nylon webbing with a double locking snap at one end and a double locking ladder hook (2.5" gate opening) at the other end. Now available with integral shock absorber (Zorber™). New labeling.

Minimum Tensile Strength: 5,000 lbf.

Meets all ANSI, OSHA standards and CSA construction requirements.

		Length
752056	Snap / Hook (shown)	6'
752348	Adjustable, Snap / Hook	3'-6'
752346	Adjustable, Snap / Snap	3'-6'



Twin Leg Tower Lanyard, AutoLock

TWIN LEG BYPASS LANYARDS



100% Tie Off

Special design Lanyard with Zorber to be used for 100% tie-off method of climbing safety. One end has a double-locking safety snap or rapid link that attaches to harnesses. The "Legs" of the lanyard are complete with large 2.50" opening double locking Ladder Hooks. Meets all ANSI, OSHA standards and CSA construction requirements.

752265	AutoLock, Steel
752265A	AutoLock, Aluminum
752275	Aluminum with Rapid Link
752264	AutoLock with Shock Absorber



WARNING

Technical rescue and safety is potentially hazardous. Any person using equipment sold by RESCUE TECHNOLOGY in any manner is personally responsible for learning the proper techniques involved, and assumes all risks and accepts full and complete responsibility for any and all damages or injury of any kind, including death, which may result from the use of any RESCUE TECHNOLOGY equipment



SHOCK ABSORBING LANYARDS WITH LADDER HOOK



Manufactured from heavy duty 1" wide nylon webbing with a double locking snap at one end and a double locking ladder hook (2.5" gate opening) at the other end. Manufactured with integral shock absorber (Zorber™). Minimum Tensile Strength: 5,000 lbf.

Meets all ANSI, OSHA standards and CSA construction requirements.

		Length
752156	Snap / Hook / Zorber	6'



ADJUSTABLE TOWER LANYARD W/ SHOCK ABSORBER



Ideal for Tower/Ladder operations.

The Tower Strap allows the firefighter enough length to complete ventilation or perform window rescues while remaining secured to the bucket or ladder. Used in conjunction with the Truck / Escape Belt or Ladderman's Class II Harness. Adjusts from 4 - 6 ft. and equipped with autolocking snap and ladder hook. Integral Zorber shock absorber limits forces in case of fall. Notice: This product must be protected from temperatures above 250 degrees Fahrenheit and direct flame impingement. (Use Fire Resistant Truck Lanyard if in doubt of heat resistant needs)



LANYARD "I"

Made from super-durable 11 mm kernmantle rope. Ideal for rope access technicians. Lengths are color-coded at the ends.

	Length	Color
7515171024WR	24 in.	Orange
7515171032WR	32 in.	Blue



ACCESS LANYARD "V"

It is used for working at height, especially for self-protection when moving from one place to another. The middle loop is attached to the harness with carabiners and energy-absorbing device. Shrink tubing protects each seam. Lanyard V has to be used as a component of a fall arrest system. Available in white/red.

	Size	Leg 1	Leg 2
751531323WR	Medium	13"	23"
751534040WR	Large	40"	40"



SITE

Work Positioning Lanyard

The work positioning lanyard with great handling makes your work safe and efficient. 11 mm rope sewn-in unopenable version of LOCKER - rope clamp. Rope covered with tubular webbing to increase wear resistance. Parking cam for locking in required position.

	Length
238910112	78"
238910114	157"



Technical rescue and safety is potentially hazardous. Any person using equipment sold by RESCUE TECHNOLOGY in any manner is personally responsible for learning the proper techniques involved, and assumes all risks and accepts full and complete responsibility for any and all damages or injury of any kind, including death, which may result from the use of any RESCUE TECHNOLOGY equipment.



REACTOR "Y"

Ideal for Rope Access

A Twin-Leg static kernmantle rope lanyard with integrated webbing shock absorber. 1000 lbf. maximum impact force. Complete with Ladder Hooks with 2.25" gate opening.

500 activation force Minimum breaking strength: 3,375 lbf.

2389441155	Reactor "Y", 62 in.
------------	---------------------



REACTOR "I"

with Shock Absorber

A Single Leg static kernmantle rope lanyard with an integrated webbing shock absorber. Complete with 1 autolocking lanyard hook.

1000 lbf maximum impact force 500 activation force Minimum breaking strength: 3375 lbf.

	Length
2389422155	Reactor "I" 62"



SINGLE RIG WEBBING LADDER

The Webbing Ladder offers the simplicity of a traditional 1" etrier but with increased comfort. Built in spreader and individual stays in the steps insures that steps remain open without causing "foot pinching". Built-in wrist loop. 6 steps.

WLL-Step: 300 lbs. WLL-Unit: 600 lbs.



758621

Height
6'



DOUBLE RIG WEBBING LADDER

Multi-Unit Connect Ability

The Deluxe Webbing Ladder offers the features of our traditional 1" Webbing Ladder plus the ability to connect multiple units together. Built in spreader and individual semi-rigid stays keeps the steps open without causing "foot pinching". Multiple ladders may be linked together. 16 steps.

WLL-Step: 300 lbs. WLL-Unit: 600 lbs.



758625

Height
15'



RESCUETECH RESCUE ETRIER

A great help in rescue. Can be used as a simple step-up or at the breakover by safety personnel. Constructed of 1" flat webbing with a protective sheath at the carabiner rigging point for extra abrasion resistance. Double thickness of webbing keep steps open and hand loop at top.

Tensile Strength: 5,000 lbf.



RESCUETECH DAISY CHAIN

Strong Rigging Loops

Traditional multiple loop rigging sling with "directional" rigging loops for higher strength. Made from 1" Tubular Webbing. Loop strength of 1,500 lbf exceeds that of competing multi-loop straps.

Ultimate Strength: 6,800 lbs. Specify Color: 36" Black or Red (9 pockets); 60" Black or Blue (17 pockets).

	Size	Length	Color
7581361	Medium	36"	Black
7581364	Medium	36"	Red
7581601	Large	60"	Black
7581606	Large	60"	Blue

		Color
758341	4 Step	Black
758342	4 Step	Yellow
758345	4 Step	Green
758361	6 Step	Black
758364	6 Step	Red
758366	6 Step	Blue



RESCUETECH DELUXE RESCUE ETRIER

Attached Rigging Sling

A modified version of our popular 4 Step Rescue Etrier. We have attached a 24" length of versatile RT Daisy Chain Webbing.

Tensile Strength: 5,000 lbf.

	Color
758542	Yellow
758545	Green

arachnipod

TOTAL EDGE MANAGEMENT SYSTEM



The Arachnipod, in its most basic form, is a simple tripod with the three legs independently pivoting from an anodized aluminum head. The modular head has a similar design to a door hinge. Inserting or removing a pin through the center of the head allows the quick and simple addition or removal of components to create a configuration to suit any edge management scenario.

Configuration	Height	SWL*	MBS	Configuration	Height	SWL*	MBS
Gin Pole	6' 9"	600 lbs.	28 kN	Tripod or Quadpod	8' 10"	880 lbs.	40 kN
Gin Pole	10"	330 lbs.	15 kN	Bridge-2 Meter	8' 10"	600 lbs.	28 kN
A-Frame, or	8' 10"	600 lbs.	28 kN	Bridge-3 Meter	8' 10"	500 lbs.	28 kN
Offset A-Frame, or	8'	750 lbs.	34 kN	Bridge-4 Meter	8' 10"	385 lbs.	28 kN
A-Frame w/ Lazy Leg	7' 6"	880 lbs.	40 kN	Handrail Recovery Monopole**		600 lbs.	19 kN

* 10:1 Safety Factor with External anchor point ** Dependent upon handrail rating

- A. Offset A-Frame
- B. Handrail Recovery Monopole
- C. Bipod
- D. High Directional Tripod w/ remote haul system
- E. Bridge System with controllable Trolley
- F. Gin Pole/Monopod
- G. Quadpod with Steps

ARACHNIPOD MULTIPOD

Intuitive Design - a Multipod for All Rescuers

Innovative design that captures multi-functional capabilities. Simplicity and robust engineering provide the world's most versatile and strongest modular total edge management system (TEMS). The Arachnipod (APOD) is one height safety edge management device that can easily adjust into multiple configurations, providing users with a safe, effective total edge management system. The Arachnipod is based around the concept of an high strength tripod however this product is much more than just a tripod. NFPA testing and certification is underway and should be complete in 2013.

Components can be added or removed as required so that the APOD complements existing structural or natural features. The unique design of the patented modular head means the Arachnipod can be constructed into many different configurations including a gin pole/monopole, bipod, tripod, quadpod, bridge system and handrail recovery monopole.

The Arachnipod has been drop test rated for a 616 lbf. rescue load. It has a tested head that has the capability of holding a high directional load as

well as a belay system. The recommended rescue belay as tested with a 280 kg rescue load is the Traverse 540 ° Belay Device.

Features:

- Easy set up
- Pins are secured to APOD with coated stainless steel cable.
- Leg stops will not allow lower portion to fall out of end.
- Rectangular Tubing and Large Pins mean less time to adjust
- 2 rigging swivel rings per basic tripod

Ideal for:

- Rescue and emergency services
- Construction
- Military
- Utility services
- Mining
- Film industry
- Maintenance personnel



ARACHNIPOD MULTIPOD SYSTEMS

PRE-BUILT KITS

Pre-built systems are ready for use upon delivery. These full systems are fully customizable with the addition of the Standard & Pulley Quadpod Add-On Kits and accessories. The components and accessories may vary from one kit to another. Please review each System's component list before placing your order.



ADVANTAGE-BASIC MULTIPOD

Standard legs with 2 Rigging Eyes

The Advantage-Basic model is the starting point for rescue and work use. Based on a traditional tripod design, the Advantage-Basic has 2 swivel rigging points underneath the "head". It is easily upgraded to a Quadpod choosing the appropriate Quadpod Add-on Kit.

Weight: 57 lbs.

Systems Built:

Tripod with 2 rigging points, Lazy Leg Tripod, Bipod/A-Frame, Lazy Leg A-Frame

Components Included:

- Standard Leg with Swivel Anchor (2) • Lazy Leg with Adaptor (1) • Feet Restraining Rope (1)
- Padded Storage Bag (1) • Manual (1)

24481105

Basic

ADVANTAGE-BASIC PLUS MULTIPOD

The "PLUS" upgrade to the Advantage-Basic adds the necessary components to increase the capabilities of the already versatile Advantage-Basic Multipod. The system adds a Gin Head, Rigging and Quad Plate, and a Reverse Head to the Advantage Multipod system.

Systems Built:

Tripod with 2 rigging points, Offset A-Frame with standard rigging point, Lazy Leg Tripod, Gin/Monopole, Bipod/A-Frame, Lazy Leg A-Frame

Additional Components Included:

- (1) Rigging Plate • (1) Quad Plate • (1) Reverse Head • (1) Gin Head

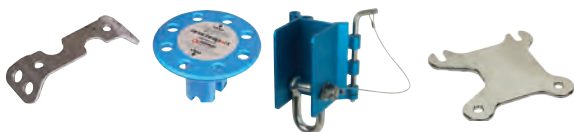

24481106

Basic Plus

ADVANTAGE MULTIPOD

Pulley leg adds over-the-top Capability

The Advantage Multipod is a step up from the Basic Multipod. The exchange of a Pulley Leg for the Standard Leg gives rescuers over-the-top capability for rope and cable systems while retaining a swivel rigging point. It is easily upgraded to a Quadpod choosing the appropriate Quadpod Add-on Kit.

Weight: 60 lbs.

Systems Built:

Tripod with pulley head and 1 rigging point, Lazy Leg Tripod, Bipod/A-Frame, Lazy Leg A-Frame, Handrail monopole

Components Included:

- Pulley Leg (1) • Standard Leg with Swivel Anchor (1) • Lazy Leg with Adaptor (1)
- Feet Restraining Rope (1) • Padded Storage Bag (1) • Manual (1)

24481205

Advantage

ADVANTAGE PLUS MULTIPOD

The "PLUS" systems are the premier multipod systems from Arachnipod. The upgraded component list increases the versatility and gives rescuers advanced capabilities. The system adds a Gin Head, Rigging and Quad Plate, and a Reverse Head to the Advantage Multipod system.

Systems Built:

Tripod with Pulley Head, Offset A-Frame with pulley high point, Lazy Leg Tripod, Gin/Monopole, Handrail Monopole, Bipod

Additional Components Included:

- (1) Rigging Plate • (1) Quad Plate • (1) Reverse Head • (1) Gin Head



24481206

Advantage PLUS

*Legs and accessories dependent upon multipod selection.

TOTAL EDGE MANAGEMENT SYSTEM



The Arachnipod Total Edge Management System (TEMS) is an innovative multipod system that captures the functional capabilities of the Arachnipod Multipod platform and turns it into a robust all-edge management system. At the heart of the TEMS is the Advantage Multipod. To this we add the Bridge Add-on and the Full Accessory kit. These features are unique to the Arachnipod TEMS. The Bridge is used to span larger openings or voids where a regular tripod or quadpod won't work. Complete with a trolley rigging point, the TEMS allows rescuers to hoist the patient then move him to the end of the bridge out of the way of the spanned void. Use of an English Reeve System further simplifies the rescue.

The Arachnipod Total Edge Management System may be rigged as:

Gin Pole (monopole / monopod), A-Frame (Bipod), Lazy Leg A-Frame, Sideways/Offset A-Frame, Tripod, Quadpod, Lazy/Easel Leg Tripod Handrail Monopod Bridge

Items included in a kit:

- (1) Arachnipod Advantage System • (1) Arachnipod 2 Meter Bridge Kit • (1) Arachnipod Reverse Head
- (1) Arachnipod Full Accessory Kit

24481301	2 Meter TEMS
24481303	3 Meter TEMS
24481304	4 Meter TEMS

ADD-ON KITS QUADPOD

The following add-on kits function perfectly with the Advantage-Basic, Advantage, Advantage-Basic Plus, and Advantage Plus Multipod Systems. It is important to note that the aforementioned Systems must be purchased to utilize the Add-on kits. **(Bridge Kit Add-On page 68)**



STANDARD QUADPOD ADD-ON KIT

The Standard Quadpod Add-On Kit provides the components necessary to add a 4th leg to an Arachnipod Multipod.

Components Included: • (1) Arachnipod Standard Leg • (1) Quad Plate • (1) Leg Bag

24481108

Standard Quadpod Kit



PULLEY QUADPOD ADD-ON KIT

The Pulley Quadpod Add-On Kit provides the components necessary to add a 4th leg to an Arachnipod Multipod.

Components Included: • (1) Arachnipod Pulley Leg • (1) Quad Plate • (1) Leg Bag

24481208

Pulley Quadpod Kit

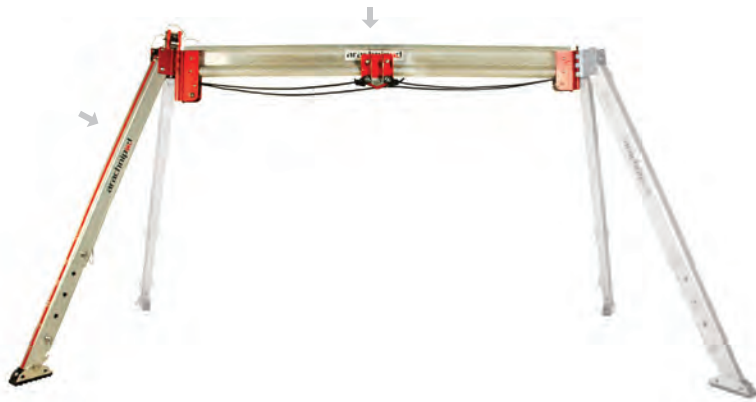

BRIDGE ADD-ON KIT

The Bridge Add-On Kits convert existing Arachnipod Multipods into a Bridge System.

Components Included:

- (1) Arachnipod Bridge • (1) Standard Leg • (1) Feet Restraining Rope

24481702	2 Meter Bridge Add-On
24481703	3 Meter Bridge Add-On
24481704	4 Meter Bridge Add-On



(top) A Frame w/ Lazy Leg & Reverse head
(bottom) Offset A-Frame

ACCESSORIES

WINCHES, KITS, PARTS



FALL PROTECTION LIFELINE WITH RECOVERY WINCH

3-Way Lifeline

Tough Aluminum housing with 3/16" galvanized steel cable with a load-indicating Autolocking Swivel Snap. Working load: 660 lbf. Meets ANSI Z359.1 and CE BS EN 360 requirements. Electrostatic powder painted. 100% inspected. Unit can be reset from winch mode back to fall protection mode. Attaches to the APOD with the mounting bracket listed below. Also, will attach to Technician Tripod (page 74) with a separate bracket.

61943050	3 Way x 50 ft.
24481690	Mounting Bracket, APOD



APOD - ACCESSORY KIT

The APOD Full Accessory kit contains many needed options for use with the Arachnipod. Included are steps that allow the user to reach the top of the tripod after set-up. Spike feet for rough terrain. A Rigging Equipment Bracket for control devices or auxiliary pulleys. Rigging Plates for stabilization. And much more.

Components Included:

- Accessory Bag (1), Spare Detent Pins (2), Spike Feet (4), Spare Leg Pins w/ Detent (1), Gin Head (1), Steps (2), Soft Ground Shoes (4), Equipment Bracket (1), Hold Down Stakes (4), Rigging Plate (1), M12 Tru-Bolts (8), Quad Plate (1), Spare Quik-Link Head Pins (2)



ARACHNIPOD WINCH

Drum winch with 6mm cable. Interfaces with pulleys or pulley in the head of the Advantage or TEMS systems.

WLL: 485 lbs.

24481620	66 ft. (20 meter)
----------	-------------------



RIGGING PLATE

The Rigging Plate is an essential piece of equipment when rigging an A-Frame/Bipod system. It provides additional lateral stabilization attachment points. The plate is for stabilization purposes and is NOT a live load rigging point.

24481211 Rigging Plate

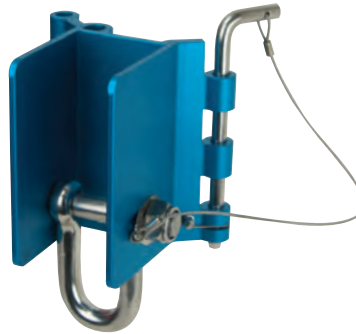

REVERSE HEAD

The Reverse Head is used to change the angle between legs. It allows a standard, equilateral tripod to be transformed into a "flat-front" tripod (Standard or Lazy Leg configurations). The Reverse Head has a large D-Shackle rigging point that centralizes the load between the opposing side legs.

24481412 Reverse Head



GIN HEAD

The Gin Head is used with the Lazy Leg to form a Gin Pole. Both Parts are colored blue to make leg selection an easy task. The Gin Head may also be used as a large rigging plate when not used in a gin pole configuration.

24481511 Gin Head



SPIKE FOOT

The Spike Foot can be used for point loading and ground penetration applications. A stainless steel tip extends the service life of the Spike Foot. Simply remove the Standard Arachnipod Foot and insert the Spike Foot into the socket at the end of the Arachnipod Leg. Foot is held in place by steel detent pin.

24481212 Spike Foot



SOFT GROUND SHOE

The Soft Ground Shoe fits over the end of the Leg and is held in place by the Spike Foot. The Soft Ground Shoe limits ground penetration.

24481515 Soft Ground Shoe



HOLD DOWN STAKE

The Hold-Down Stake can be used to secure a standard foot to the ground. The foot locating spike lines up with one of the holes in the standard foot.

24481516 Hold Down Stake



ARACHNIPIN

The ArachniPin is the new design leg pin for the Arachnipod. It is now standard on all units and replaces the original pins that were locked in place with a lynch pin. Arachnipins have a locking mechanism that is released by depressing the thumb pin. The original pins are easily replaced with the Arachnipins.

2448680054

Arachnipin

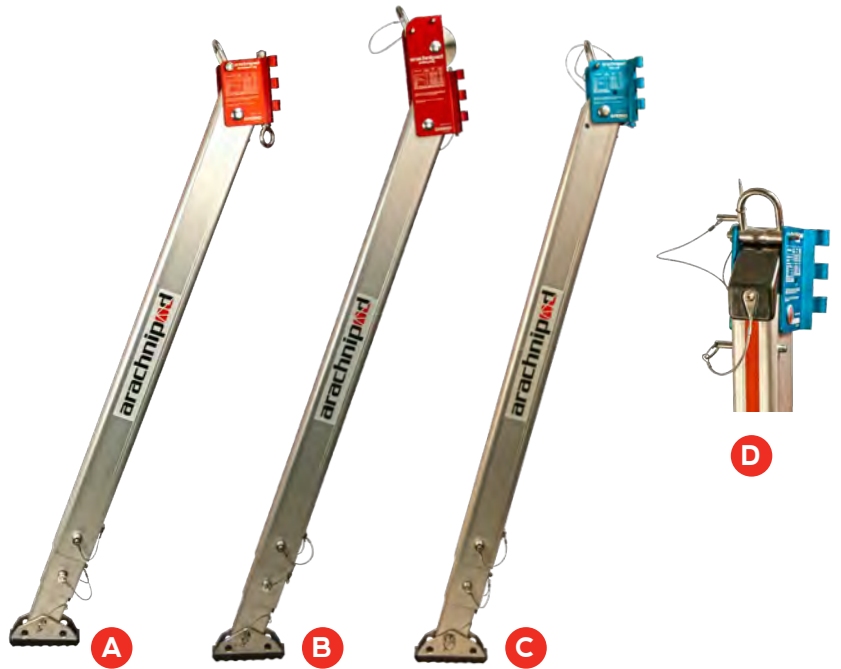

A. 24481415

Standard Leg

B. 24481417

Pulley Leg

C. 24481416

Lazy Leg

D. 24481512

Lazy Leg Adaptor

24481419

Lazy Leg Extension Bracket

24481509

Carry Bag, Single Leg

24481213

Ladder Foot



QUAD PLATE

The Quad Plate is used whenever 4 legs or heads are used together, such as a quadpod or lazy leg / reverse head configurations. The Quad Plate stabilizes the 4 head to maintain the square configuration created.

24481520

Quad Plate



LEG RIGGING BRACKET

The Equipment Bracket is attached to the lower leg section for use with mechanical advantage rigging. It can be rigged inward for use with the swivel rigging points or outward for use with the pulley head.

Load ratings per leg settings: A1: 330 lbs; B2: 485 lbs.; C3: 661 lbs.

24481519

Leg Rigging Bracket



LEG STEP

The Leg Step is probably the handiest accessory for the Arachnipod. The Step can be attached to the middle or lower leg sections and is a useful aid when you need to reach the rigging points of a fully extended Arachnipod. The Steps are reversible and may be used inside or outside of the leg. The Step is not rated for rescue load applications.

24481518

Leg Step



Over-the-Top sheaves accommodate cable or rope.

Swivel Eye Rigging Points (2)

Spring-Lock Mechanism Locks Legs into Place

DELUXE TECHNICIAN TRIPOD

Pulley Sheaves in Head for Rope/Cable

2 Swivelling Rigging points. Spring loaded leg locking mechanisms hold legs in place. Sheaves on head of tripod allow for integration of winches and fall blocks while allowing for increased height under the tripod head. Extruded head and snap out legs for quick and positive deployment. Available with optional load indicating attachment eyes. Manufactured from high strength alloy aluminum and stainless steel fittings.

Strength: 8,093 lbf. (36 kN) WLL: 809 lbs. (368 kg) Weight: 51.75 lbs (23.53 kg) Maximum Open Height: 99.6" Minimum Open Height: 70" Storage Dimensions: 72" x 8.5" x 8.5"

6194101	Tripod
6194109	Tripod Bag

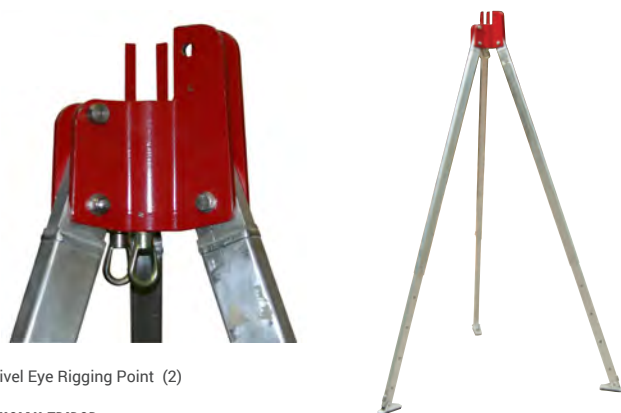

Swivel Eye Rigging Point (2)

TECHNICIAN TRIPOD

To create a lighter, more economical tripod, we removed the sheaves from the Technician Tripod. What remains is the same high strength unit with 2 swivel rigging points. You can add the Pulley sheaves back to the unit with the Sheave Kit.

Strength: 8093 lbf. (36 kN) WLL: 809 lbs. (368 kg) Weight: 48.5 lbs (22 kg) Maximum Open Height: 99.6" Minimum Open Height: 70" Storage Dimensions: 72" x 8.5" x 8.5"

6194103	Technician Tripod-Basic
6194105	Pulley Wheel Kit, each



Winch Bag shown with Tech Tripod Winch



TECHNICIAN TRIPOD WINCH

The ISC Tripod Winch is ideal for use in lifting and lowering applications. The Winch has a working length of 65ft (20m). To be used with a secondary back-up system such as the EXTRACTOR CSR Kit. Includes Steel Swivel eye, double-action Snaphook. We built the Winch Case to fit the ISC Tripod Winch. The case is built from 1000 den Cordura fabric with foam and hard plastic interior shell to increase durability.

Case dimensions: 21" x 12" x 7"

61946065	Tripod Winch, 65 ft.
61945059	Winch Case, Soft Side



WARNING

Technical rescue and safety is potentially hazardous. Any person using equipment sold by RESCUE TECHNOLOGY in any manner is personally responsible for learning the proper techniques involved, and assumes all risks and accepts full and complete responsibility for any and all damages or injury of any kind, including death, which may result from the use of any RESCUE TECHNOLOGY equipment.



LARKIN RESCUE FRAME

An uneven tetrahedron that can replace a tripod or a small rooftop derrick crane for personnel lifting/lowering. The Larkin Frame swivels on its feet and can be set up as a standard tripod or tipped as shown in the photo to reach over an edge or parapet wall. It is especially useful on horizontal tanks with half walkways. The two feet must be secured to prevent slippage away from the breakover when the unit is tipped. Made in Australia. Patented

Safe Working Load: 600 lbs. Dimensions: 8' x 10' Weight: 87 lbs. Shipping Weight: 94 lbs.

900200 Larkin Frame



SKED EVAC TRIPOD

The Sked Evac Tripod extends to 9.9 feet with three anchors at the head. Anchors, Header, and Legs are interconnected with 1/2" Stainless Steel bolts for high strength.

Extension 6' - Strength: 5,280 lbf. WLL: 528 lbs. OSHA Rating: 1 Person Bag Dimensions: 89" x 6" Weight: 71 lbs. NFPA Rating: Light Use

Extension 9' - Strength: 9,500 lbf. WLL: 950 lbs. OSHA Rating: 1 Person Bag Dimensions: 89" x 6" Weight: 71 lbs. NFPA Rating: Light Use

620510 Evac Tripod
620511 Carrying Bag for Evac Tripod



ISC MERLIN FALL BLOCK

The Merlin™ Fall Arrest Block is the next generation of Fall Protection Systems from ISC. The new design features an offset attachment hole, designed to position the block in order to keep the working line free from bends during use. Includes fall indicating snap.

WLL: 310 lbs. (140 kg) Maximum Arrest Distance: 54" (137.2 cm) Standards: EN3360:2002, ANSI Z359.14

		Weight
2014821050	Merlin Fall Block, 33 ft.	8.4 lbs (4 kg)
2014821150	Merlin Fall Block, 50 ft.	16.3 lbs (7.4 kg)



FALL PROTECTION LIFELINE WITH RECOVERY WINCH

3-Way Lifeline

Tough Aluminum housing with 3/16" galvanized steel cable with a load-indicating Autolocking Swivel Snap. Working load: 660 lbf. Meets ANSI Z359.1 and CE BS EN 360 requirements. Electrostatic powder painted. 100% inspected. Unit can be reset from winch mode back to fall protection mode. Attaches to the APOD with the mounting bracket listed below. Also, will attach to Technician Tripod (page 74) with a separate bracket.

61943050 3 Way x 50 ft.
61943059 Mounting Bracket



SKYHOOK RESCUE WINCH

The SkyHook system is comprised of an anodized aluminum two-speed self-tailing winch, handle, and mounting system. Will connect to the Sked Evac Tripod. Offers ease of raising & hauling loads without the use of bulky block & tackle-style mechanical advantage systems. Best used with 1/2" ropes.

Weight: 21.5 lbs.



615201

SkyHook Rescue Winch



SKYHOOK UNIVERSAL ANCHOR PLATE

Provides the winch a stable work platform for anchoring the winch to the ground, telephone poles, etc.

Weight: 9.7 lbs.



615205

Universal Anchor Plate

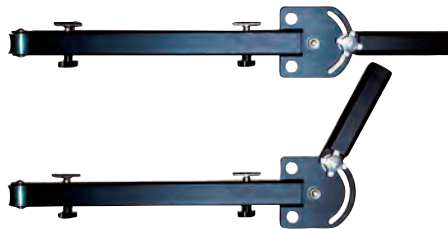

SKYHOOK RECEIVER HITCH MOUNT

Allows the SkyHook winch to be mounted to a vehicle using a standard receiver hitch. The mount will pivot up to 45° in each horizontal direction to achieve proper rigging alignment.



615202

Receiver Hitch Mount



SKYHOOK WEB ANCHORS

The SkyHook Web Anchor Set allows rescuers to quickly attach the Skyhook winch around a column, tree, abutment, etc. Very useful in Industrial and rural applications. Strong ratchet adjusters provide a tight and secure attachment.

615206

Web Anchors



SKYHOOK POWER DRIVE

An electric powered power head turns the winch head. Includes Power Drive, stainless steel drive bit, attachment bracket, and storage box. 110 VAC.

Weight: 15.5 lbs. (With case: 21.2 lbs.)

615210

Skyhook Power Drive



SKYHOOK CASE

Holds winch and winch drive system as well as Universal Anchor Plate.

615209

Skyhook Case





SKYHOOK LIGHTWEIGHT RESCUE WINCH

The new lightweight version of the SkyHook rope winch system provides the same efficient, safe, durable and user-friendly operation as the Classic model with the benefit of having a lower weight, but without losing any quality or gear ratio. The SkyHook Lightweight Winch attaches to all of the SkyHook accessory products, and can accommodate the AC or DC battery powered electric Power Head Systems. The universal anchor mount can connect quickly to a Tripod systems legs, but has the flexibility to be attached to a variety of structures via tie down holes, webbing straps or a trailer hitch where a remote work site is involved.

The lightweight 2-speed winch is CE approved.

615201L Skyhook Lightweight



TRAILTECH RESCUE WINCH

The TrailTech winch is equipped with a shaft that accommodates the double handles. Similar to a bicycle pedal system, it provides the maximum output for a manual operated winch. The double handles of the Harken winch attached to the SkyHook TrailTech bracket provides the mechanical advantage and ergonomic ease for a single-man operation to efficiently lift loads not possible by one person manually. The universal anchor mount can connect quickly to a Tripod systems legs, but has the flexibility to be attached to a variety of structures via tie down holes, webbing straps or a trailer hitch where a remote work site is involved. Because of the low profile of the TrailTech Winch handle cranks, the handles do not rotate fully when used with the Universal Anchor Plate or Webbing Anchor Ratchet Systems. The TrailTech Riser is required for use with the Universal Anchor Plate and Webbing Anchor Ratchet systems.

The TrailTech system is CE approved.

Shown with optional TrailTech Riser and Universal Anchor Plate (not included)

615403 TrailTech Winch
615403C Case for TrailTech Winch



SKYHOOK "T" OFF-ROAD FOUNDATION

This attachment gives the winch a large base for ground operations.

Weight: 4.8

615204 Ground Stabilizing Mount



TRAILTECH RISER

The anodized aluminum square Riser adapter is designed and required to raise the rear of the "TrailTech" and is required to allow the double handles to clear the flat base of the Universal Anchor Plate, and when using the Webbing Ratchet Strap Anchoring System. Shown in the images above is the raw Aluminum Riser. All SkyHook Rescue Systems Accessories accept the stainless steel 3/8" ball lock pins or the stainless steel 3/8" T bolts and anodized hand nuts security hardware.

615405 TrailTech Riser Adaptor



UNIVERSAL TRIPOD BRACKET

Designed to allow the Skyhook to fit the ISC Technicaian Tripod and the Arachnipod Multipod systems (requires 615211B Bolt Set).

615211 Skyhook UTB
615211B Bolt Set, Arachnipod



HARKEN RIGGERS WINCH 500

The Riggers Winch provides the user with a lightweight, CE certified, portable winch mounted to a robust adaptor plate. Available in two sizes the Riggers Winch 200 and 500. The Riggers Winch 500 weighs 7 kg (15.4 lb) with a 1/2 tonne working load limit, the 2 speed winch magnifies the operator pulling power by up to 40 times. The multiple mounting options provides versatility when working in difficult or remote environments. Design The mounting plate is sculpted to remove excess weight and provides multiple attachment points without compromising strength. The pigtail line lead ensures correct alignment and loading of the winch for maximum efficiency. Aluminum 40.2 winch features 17-4 PH stainless steel load-carrying gears and pins for strength and durability. The unique drum design maximizes grip on the rope. The winch is designed for use with fiber rope up to 1/2" (12 mm) in diameter, reducing weight and allowing alignment to the load. Smooth surfaces and chafe-free design. Rigging straps not included.

233623500



LOKHEAD WINCH

This man-riding portable capstan winch is designed for confined space retrieval or for use with davit systems using an unlimited length of fibrous rope. The captive head allows the winch to be used safely, and keeps the rope from accidentally releasing. The LokHead can be used anywhere a load needs to be lifted and lowered. Rigged to a tripod, it can be used for confined-space rescue, for load moving/hauling, and man-riding.

23365002



POWER DRIVE FOR HARKEN WINCH

A cordless drill adapter for use with Harken winches. Fits drill motors with 3/8" chuck.

Weight: 2.5 oz.

23367431



RATCHET RIGGING STRAP FOR RIGGER WINCH

Handy adjustable rigging straps to mount the Rigger winch to trees, columns, bridge abutments, etc. A minimum of 2 should be used to attach the Rigger Winch to a structure.

WLL: 3,330 lbs.

2336901104

10 ft.

2336901204

20 ft.

STRETCHERS & LITTERS

PATIENT TRANSPORT

RescueTECH offers the best of Rescue Stretchers and Backboards for Technical Rope Rescue. Galvanized Steel Stretchers, Stainless Steel Stretchers, Plastic Stretchers, Marine Wood Back Boards, Plastic Backboards. Includes products by RescueTECH, Traverse, Junkin. Great for High Angle Rescue, Confined Space Rescue, Water Rescue, Search and Rescue.



STRETCHER TRAILER

Aluminum Litter Trailer for litter transport. Easily disassembles for storage. Nylon Powder Coated. Sets up in approximately 3 minutes. Litter not included.

Ground Clearance: 21" Length: 72" Width: 27" or 40" Weight: 71 lbs.

Litter not included.

620350	Stretcher Trailer
620355	ATV Adapter Kit



ATV Adapter Kit



Stretcher not included

MULE LITTER WHEEL WITH HANDLES

8-Way Adjustable Handles

This is a modified version of the Original MULE Litter Wheel that adds handles to both ends of the unit. The single-wheel design allows for ease of movement in the roughest terrain. Ideally suited for narrow rough trails giving the patient a smooth ride even across slopes. The two securing straps (2 hooks per strap) are each rated to 1,000 lbf. and use a strong and durable ratchet-locking device.

Shipping Weight: 45 lbs.

620361	Mule Litter Wheel w/ Handles
--------	------------------------------



RESCUETECH TAPERED STOKES STRETCHER



The RT Stretcher provides an economical choice for the rescue professional. Cold Rolled tubing and a full length steel strip backing for strength and rigidity.

Dimensions: 84" x 23.5" x 7.25" Interior Depth: 6" Strength using standard rigging points: 2550 lbf. Weight: 34 lbs. vShipping Weight: 40 lbs.

Product features: .25" Diamond Mesh insert • Full length steel strips provide backboard-like rigidity* • Rescue-Grade Patient Straps • Electrostatic Powder Coat Finish

*Does not replace proper patient packaging using backboard, cervical collar, and headblocks. Shipped via motor freight.

620112	Tapered Stokes Stretcher
--------	--------------------------



RESCUETECH RECTANGULAR STOKES STRETCHER



The Rectangular Stretcher builds on our popular Tapered Stretcher design. It is designed to be symmetrical from end-to-end and to allow larger sized, rectangular backboards to easily fit inside. Cold Rolled tubing and a full length steel strip backing for strength and rigidity.

Dimensions: 84" x 23.5" x 7.25" Interior Depth: 6" Strength using standard rigging points: 2550 lbf. Weight: 37 lbs. Shipping Weight: 43 lbs.

Product features: .25" Diamond Mesh insert • Full length steel strips provide backboard-like rigidity* • Rescue-Grade Patient Straps • Electrostatic Powder Coat Finish

*Does not replace proper patient packaging using backboard, cervical collar, and headblocks. Shipped via motor freight.

620114	Rectangular Stokes Stretcher
--------	------------------------------



RESCUETECH CONFINED SPACE STOKES STRETCHER



An updated version of the traditional wire mesh stretcher. This version features our popular 0.25" durathene mesh insert and rescue-grade straps. Tested to 1500 lbs.

Dimensions: 81 1/2" x 18 3/8" x 7 3/4" Strength: 2550 lbf. Weight: 32.6 lbs. Shipping Weight: 38 lbs.

*Does not replace proper patient packaging using backboard, cervical collar, and headblocks. Shipped via motor freight.

620113	Stokes Stretcher
--------	------------------



RESCUETECH STAINLESS STEEL RECTANGULAR STOKES STRETCHER



A stainless steel version of our Rectangular Stokes Stretcher. Includes a special Mesh insert with a .25" diamond pattern for greater strength, and better patient packaging than .5" patterns. A new style ABS back plate provides a sturdy, yet comfortable base for the patient. We have also added rescue-grade nylon Quick-Fit Stretcher Straps for securing the patient.

Dimensions: 84" x 24" x 7.25" **Interior Depth:** 6" **Strength using standard rigging points:** 2550 lbf. **Weight:** 29.3 lbs. **Shipping Weight:** 35 lbs.

*Does not replace proper patient packaging using backboard, cervical collar, and headblocks. Shipped via motor freight.

620124

S.S. Rectangular Stokes



RESCUETECH EXTRA-WIDE STOKES



For those special rescues where the basic sized stretcher will not work. 32" wide at the rail and lined with our 0.25" diamond pattern durathene mesh. Included 4 rescue-grade patient straps*.

Dimensions: 85" x 32" x 8" **Strength:** 2550 lbf. **Weight:** 31 lbs.

*Does not replace proper patient packaging using backboard, cervical collar, and headblocks.

620125

RT Extra-Wide Stokes



RESCUETECH STAINLESS STEEL TAPERED STOKES STRETCHER



Super Strong to meet Mil-Spec

We designed this stretcher based upon Junkin's top of the line Military Stainless Steel stretcher. This stretcher meets the Mil-Spec 2,500 lb. load rating - tested from the ends of the stretcher to give a more accurate measure of strength*. We add a special Mesh insert with a .25" diamond pattern for greater strength, and better patient packaging than .5" patterns. A new style ABS back plate** provides a sturdy, yet comfortable base for the patient. We have also added rescue-grade nylon Quick-Fit Stretcher Straps for securing the patient.

Dimensions: 84" x 24" x 7.25" **Interior Depth:** 6" **Strength using standard rigging points:** 2,500 lbf. **Shipping Weight:** 33 lbs.

Shipped via motor freight. *Other brands test from rigging points to give an artificially higher strength rather than the required Mil-Spec Strength rating. **Does not replace proper patient packaging using backboard, cervical collar, and headblocks.

620122

S.S. Tapered Stokes



QUICK-FIT™ STOKES LASHING SET



Packaged set of RescueTECH's Quick-Fit Stretcher Straps. Provides rescue-grade outside lashing for the vertical environment. Complete with 4 red and 1 Yellow strap and storage pouch.

Weight: 54 oz.

6201530

Quick-Fit Lashing Set



CLIK-LOK STOKES LASHING SET



We have updated our popular Stokes Lashing set with our rescue grade Click-Lok Buckles. These buckles "click" together like a seat belt buckle. But, they are rescue strength and require that both release tabs be depressed before the buckle will open. Includes 5 Straps (1 yellow, 4 red) and deluxe storage/carrying bag.

6201535

Click-Lok Lashing Set



CONFINED SPACE LITTER



A narrow version of the Wire Basket Stretcher. Only 19" wide and fits through nearly all accessible manholes. Used with either 4 or 6 point litter bridles. Hexagon mesh wire netting. Tested to 1500 lbs.

Dimensions: 81 1/2" x 18 3/8" x 7 3/4" **Weight:** 23.7 lbs. **Shipping Weight:** 29 lbs.

Shipped via motor freight.

620103

Confined Space (JSA-300CS)

\$365.00

WIRE BASKET STRETCHER



Traditional design wire basket stretcher manufactured from rugged 5/8" tubular steel frame with 3/16" x 3/4" flat wire braces. Hexagon mesh netting (18 gauge). Used with either 4 or 6 point litter bridle. Tested to 1500 lbs.

Length: 80.5" **Widths:** 22 1/2"- chest, 22"- abdomen, 21.5"- thigh, 20.5"- calf **Height:** 8" **Weight:** 25.6 lbs. **Shipping Weight:** 31 lbs.

Shipped via motor freight.

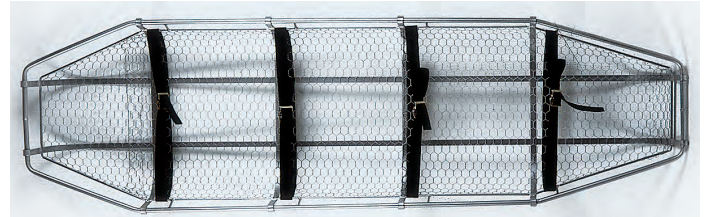

620101

Wire Basket Litter (JSA-300W)

PLASTIC STRETCHER



The Plastic Stretcher combines the open top railing desirable on standard wire basket litters with the plastic bottom desired for smooth transport. Made from yellow, high density polyethylene shell, supported by a Stainless Steel outer rail. Shell is permanently attached to rail using semi-tubular Stainless Steel rivets (not pop rivets). Steel rail facilitates handling of the stretcher at all points along sides and ends of stretcher. Includes molded runners and a sealed, closed cell foam pad. The Plastic Stretcher will accept a full size rectangular backboard.

Load capacity: 1,200 lbf. **Dimensions:** 84.5" x 24" x 7.5" **Weight:** 31.6 lbs. **Shipping Weight:** 37 lbs. **Color:** Yellow

Shipped via motor freight.

620115

Plastic Stretcher (JSA-200)



MASS CASUALTY FLEXIBLE STRETCHER



Constructed of specially compounded orange or gray 18oz. vinyl-coated nylon that is easily washed with soap and water. Highly resistant to acids, alkalis and penetration of liquids. Five (5) removable hardwood slats positioned between two layers of the 18oz. fabric provide strength and rigidity. Shorter slats are placed in torso area only to make stretcher lighter and more compact. Lightweight – 13 lbs. Compact and portable – opens to 78"L x 28"W; closes to 35"L x 6"W. Six (6) handles ergonomically placed for ease of transport. Three (3) polypropylene web patient security straps for immobilization. Load capacity – 350 lbs. Carry bag with shoulder strap. One person can carry up to ten (10) of these stretchers when responding to an incident.



Color

Orange

Grey

20701040

20701047



ADJUSTABLE LITTER BRIDLE

Vertical, Horizontal, and Low Angle Lifting

Same as our original 4-Point Litter Bridle but with 1 3/4" forged adjusters. Adjusters allow for independent adjustment of the four support straps during rescue. Complete with 3" forged "O" ring and 4 locking litter snaps. Also available without snaps to use with heavy duty carabiners for litter attachment. Converts for low angle use. Tensile Strength: 5,000 lbf. Color: Orange with contrasting straps. We suggest the 60511830 RescueTECH Large D, Steel Carabiner. Bridle Kit includes: Bridle, Tender Rope and Carrying Bag.



		Weight
620185	Bridle w/ Snaps	7.15 lbs.
620188	Bridle w/ D-Rings	4.15 lbs.
620189S	Bridle Kit w/ Snaps	8.75 lbs.
620189	Bridle Kit w/ D-rings	5.4 lbs.
6201892	Quik-Pik Bridle w/ D-rings	6.4 lbs.



CONVERTIBLE LITTER BRIDLE

Vertical, Horizontal, and Low Angle Lifting

Ideal for all standard lifting applications. Designed for single rope rigging, the 4-Point Litter Bridle attaches directly to the railing of all types of stretchers. Two 1" heavy duty type 18 nylon slings (Webbing Strength: 6000 lbf.) are looped through a 3" forged steel lifting ring to allow end-to-end height adjustment. Connects to litter with four forged locking snap links (included).

WLL: 600 lbs Weight: 4.75 lbs. Color: Red



620180 4-Point Convertible Litter Bridle



LITTER ATTENDANT SLING

A handy adjustable sling that attaches to litter railing with a girth hitch. Similar in design to our standard transfer sling. V-ring adjuster attaches to rescuer. Great for litter transport.

Extended Length: 40" Weight: 8 oz.



756111 Litter Attendant Sling



2-PIECE LITTER PRE-RIG

The Pre-Rig is a fully adjustable bridle intended for use with any Stokes litter. The unique "Y" suspension system drastically reduces congestion at the upper attachment point. Adjustable to a minimum height of 18" above the litter for the tightest helicopter evacuations and a maximum length of 5 feet. One half of the Pre-Rig can be used as a low angle evacuation stretcher harness, eliminating the need to purchase separate harnesses. Combines with a rescuer rigging rope or Transfer Sling for a complete litter/rescuer system. Litter Pre-Rig is made of 6,500 lbf. webbing and quick adjust Mil-Spec forged hardware.

Strength: 5,000 lbf. Weight: 3 lbs.

All webbing and hardware meet NFPA strength specifications.



620183 2 Piece Litter Pre-Rig



LOW-ANGLE LITTER BRIDLE

Ideal for scree-slope and other low angle litter operations. Provides stable, secure connection. Manufactured of high strength webbing and forged steel hardware. Attaches to sides and end of litter.

Strength: 5,100 lbs. Weight: 2.3 lbs. Color: Black



620181 Low-Angle Litter Bridle



STRETCHER EQUIPMENT PACK

Holds all Harness and Hardware

A new equipment pack designed to hold all items needed for securing patient and stretcher movement in a vertical environment. Two zippered pockets hold webbing, hardware, litter bridles, victim harnesses, and much more (not included). Come complete with carrying handle. Stretcher attachment system is complete with high strength buckles.

Dimensions: 18" x 10" x 5" Weight: 27 oz.



620172 Stretcher Equipment Pack

PATIENT STOKES HARNESS



Special design harness that provides inside patient lashing. Designed to stay attached to stretcher then attached to patient. Complete with chest and seat harness section. Easily donned. To be used in addition to a rescue-grade wire basket or plastic stretcher with proper technical rescue patient lashing. Stretcher and Manikin not included.

Weight: 40 oz.



6201540

Patient Stokes Harness

PATIENT PACKAGING SET



Complete system for patient restraint in the vertical environment. Set includes Stokes Harness, Patient Lashing Set (Clik-Lok or Quick-Fit), and Stretcher Equipment pack. Stretcher and Manikin not included.

Weight: 7.35 lbs.



*Manikin and Stokes not included

299842121

Quick-Fit™ Patient Packaging Set (shown)

299842125

Clik-Lok Patient Packaging Set



Clik-Lok



Quick-Fit



STRETCHER HARNESS SET

An upgraded version of our original Patient Packaging set. We have added Litter Bridle and equipment for the attendant(s). Stretcher and Manikin not included.

- Stretcher Patient Harness (1) • Clik-Lok Stretcher Lashing set (1) • Stretcher Equipment Pack (1) • RD70 Carabiners (4) • OD50 Carabiner (1) • Litter Attendant Sling (4) • Gibbs Ascender (2) • Deluxe • Rescue Etrier (1) • Adjustable 4 pt Litter Bridle Kit (1)



299842130

Stretcher Harness Set



STRETCHER BLANKET

Traditional Packaging Tool

The finest cot and stretcher blanket available for patient packaging. Provides excellent insulation characteristics. Note: Proper basket litter operations require a minimum of two blankets. 70% Wool, 30% Synthetic Fiber.

Size: 82" x 62" Weight: 42 oz.

620160 Stretcher Blanket



HEAVY DUTY SPACE BLANKET

Lightweight Superinsulator

Reflects and retains up to 80% of radiated body heat to prevent post trauma shock resulting from an accident or natural disaster. Waterproof, windproof and durable. Multiple layers are flexible even in sub-freezing temperatures.

Dimensions: 84" x 60" Weight: 12 oz.

620165 Heavy Duty Space Blanket



EMERGENCY BLANKET

Known for years as a Space Blanket, this mylar sheet works great as a thermal insulator. Small enough to fit in your shirt pocket, yet opens to a full 56" x 84" size. Stays flexible in freezing temperatures. Wind and waterproof.

Weight: 1.5 oz.

2282127032 Emergency Blanket



CMI DRAG HOOK

Manufactured of forged steel eyebolt and five 4140 chromemoly steel tines. Each tine is heat treated to resist a load of approximately 2,000 lbf. Each Drag Hook is sandblasted and coated with baked-on epoxy coating. Available Deployment Bag is specifically designed for use with the Drag Hook.

Dimensions: 12.75" x 8.5" Weight: 2.75 lbs. Color: Black

624100 Drag Hook
624105 Deployment Bag



STADIUM SEAT

For use in fast, safe transportation of victims from stadiums, sport facilities, arenas, theaters, or anywhere multiple steps create problems in removing patients. Lightweight - weighs only 4.5 lbs. Strong - accommodates up to 350 lbs. Durable - made of 18oz. vinyl and hardwood slats. Compact - folds to 20" x 7" in carrying bag. Safe - 2 nylon seat belts secures patient. Portable - can be stored in a minimum of space. Easy to use - 5 web handles for lifting and carrying.

20700059 Stadium Seat



LITTER COVER

Protects Stretcher from the Elements

Manufactured from durable vinyl coated polyester for extra strength and durability. Double stitched seams and Vislon Zipper. Compression straps secure the bag to the stretcher. Zippered opening of 1/2 of the top panel eases insertion of the stretcher. Fits all standard and confined space stretchers.

Dimensions: 90" x 30" x 10"
Stretcher not included.

620175 Litter Cover



BASKET STRETCHER FLOTATION KIT

For use with all basket stretchers to provide flotation during patient handling in water. Easily attached with hook and loop fastener to any Stokes type stretcher. Flotation bats are Dow EthaFoam and covered in Cordura™ Nylon. Kit is ready to attach to any Junkin stretcher.

Weight: 5 lbs. Color: Orange.

620321 Flotation Kit

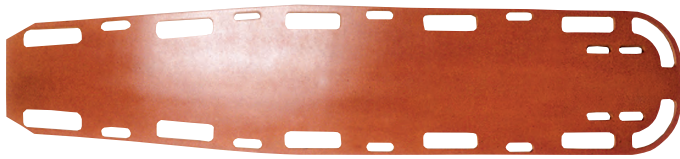

MARINE PLYWOOD BACKBOARD

Manufactured of 3/4" weather-proof Marine Plywood finished with two coats of clear varnish. Large hand cut-outs for easy handling. 3/4" runner on bottom for easy lifting. Special shape fits inside Wire Basket Stretcher. Speed clip version requires purchase of up to 5 Speed Clip Straps.

Shipping weight: 23.5 lbs. Dimensions: 73" x 17" x 3/4" Weight: 18.3 lbs.



620231 - Speed Clip Straps

620201	Full Length
620202	Full Length, Speed Clip Pins
620212R	14" Confined Space (runners)
620231	Strap for Speed Clip Boards



LIGHTWEIGHT BACKBOARD

X-Ray Translucent Molded Plastic

Manufactured from the highest grade PVC. Special design is lightweight and easy to clean. Compatible with Patient Restraint Straps and Backboard Strap.

Shipping Weight: 22 lbs. Color: Yellow Dimensions: 73" x 17" x 3/4" Capacity: 400 lbs. Weight: 18.3 lbs.



620210	L/W Backboard
620211	L/W Backboard w/ Pins



XTRA BACKBOARD

Standard and Pin Versions

Designed to be one of the most rigid backboards available. Fully x-ray transparent between the handholds and provides approximately 50% greater clear area at the head of the backboard. High buoyancy for water rescue. Works with all head immobilizers and strapping systems. Easily cleaned. Version with Pins has 14 pins for precise strap placement.

Shipping Weight: 20 lbs. Colors Available: Yellow (2), Orange (0), Red (4), Blue (6). Substitute number in parentheses for the "X" in the stock number. Dimensions: 71" x 15.75" Capacity: 500 lbs. Weight: 17 lbs.



2149810x	Xtra Backboard
2149820x	Xtra Backboard w/ Pins



ALUMINUM DECON POLE STRETCHER

Open Mesh Design

Ideal for decontamination. Easily set up and compact for storing. This Medical Corps type litter is light in weight with shaped hardwood handles. Cover is durable 18 oz. vinyl coated nylon.

Open Dimensions: 87" x 22" x 4.5" Folded Dimensions: 43.5" x 3.5" x 7.5"



2026601M	Aluminum Decon Pole Stretcher
----------	-------------------------------

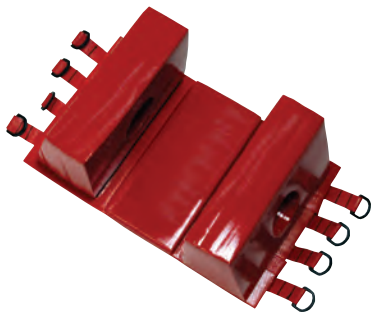

BACKBOARD HEAD IMMOBILIZER

Designed and recommended for immobilization only. Item includes: two head support pillows with ear openings; base with center pad and two backboard retention straps; straps for head positioning; and a vertical stabilization strap to maintain immobilizer placement at head of the board.

620224	Head Immobilizer
--------	------------------



AMBU PER-FIT ACE

The Per-Fit Ace adjusts to ANY adult-size neck with 16 different settings ranging from neckless to tall.

• Stores completely flat • Horizontal sizing line • Radiolucent, CT & MRI compatible • Safety buttons for maximum reliability

23466884	AMBU Per-Fit Ace, Adult
23466882	AMBU Per-Fit Ace, Pediatric

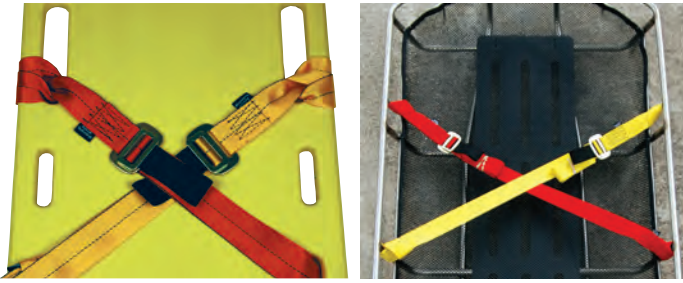

QUICK-FIT PATIENT STRAPS™

For Backboards and Stretchers

A rescue-grade strap for use with stretchers and backboards. 2 piece versions consists of two straps with a loop at one end, to girth hitch around stretcher rail, and a connector at the other end. 1 piece version is a single strap designed to wrap completely around a backboard or litter. An excellent alternative to “seat buckle” style connectors. Two-piece buckle is manufactured of steel and require movement in two planes to detach. Easy to connect and adjust. Suitable for Technical Rescue Use.

Color: Yellow WLL: 600 lbs. Length, 2-pc: 70” Length, 1-pc: 108”



		Color
6201522	2-Pc Quick-Fit	Yellow
6201524	2-Pc Quick-Fit	Red
6201521	2-Pc Quick-Fit	Black

		Color
6201532	1-Pc Quick-Fit	Yellow
6201534	1-Pc Quick-Fit	Red
6201531	1-Pc Quick-Fit	Black



CLIK-LOK PATIENT STRAPS™

For Backboards and Stretchers

Manufactured with our new Clik-Lok Buckle, the 2-Piece version is affixed to backboards and stretchers with a girth hitch. The 1-Piece wraps completely around the backboard or litter. Constructed of 1.75” flat nylon webbing (Tensile Strength: 5,500 lbf.) and Clik-Lok adjuster buckles. We recommend crossing the chest area using different color slings to aid in proper buckle attachment.

Strength: 5,500 lbf. WLL: 600 lbs. Length 2pc.: 70” Length 1pc.: 108” Weight: 11.2 oz.



		Color
6201512	2-Pc Clik-Lok	Yellow
6201514	2-Pc Clik-Lok	Red
6201511	2-Pc Clik-Lok	Black

		Color
6201562	1-Pc Clik-Lok	Yellow
6201564	1-Pc Clik-Lok	Red
6201561	1-Pc Clik-Lok	Black

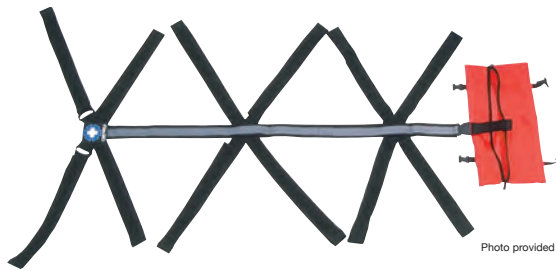

Photo provided by: Conterra

TRIPLE X BACKBOARD STRAP™

Innovative Design from Conterra

New strap system that has twelve separate overlapping Velcro® straps that quickly and securely immobilize a spine injured patient to virtually any spine board. Easy deployment. Simply align the three sets of “X” formation straps over the corresponding weight centers of the body (upper chest, pelvis, legs). Thread tie straps through the backboard holes and pull tight. Machine washable 2” webbing, 1.5” velcro. Reflective striping on center alignment strap. Complete with zippered carrying case.

Weight: 28 oz.



621131	Triple X BackBoard Strap
--------	--------------------------



Backboard not Included

STANDARD BACKBOARD MULTI-STRAP

Traditional Design

Strap system that has eight straps that quickly and securely immobilize a spine injured patient to virtually any spine board. Easy deployment from included storage bag. Thread straps through the backboard holes and pull tight. Machine washable 1.5” webbing, 1.5” velcro. Reflective striping on center alignment strap. Complete with zippered carrying bag that will attach to backboard or litter for convenient storage.

Weight: 22.5 oz.



620155	BackBoard Multi-Strap
--------	-----------------------

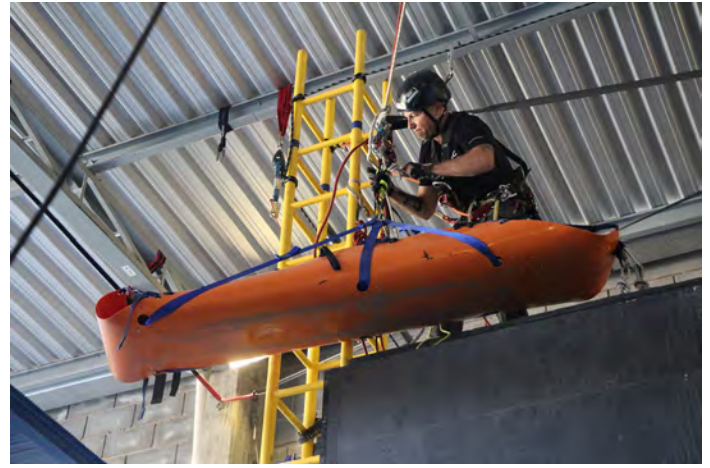

H-STR II CONFINED SPACE / RIT STRETCHER HALF-SIZED WITH INTEGRAL PATIENT HARNESS

Includes Integral Patient Lifting Harness

A half-sized version of the STR II. Ideal for confined space use and firefighter evacuation. Features patient harness, foot loops and horizontal/vertical lifting straps. Horizontal lift strap loops serve dual use as lifting handles. Color coded strap system: Patient (Yellow), Closure (Black), Lifting (Blue). Can be used to move patient out of a 90 degree turn in a pipe. Automatic rescue strength locking buckles speeds securing patient in the STR II. Features stainless steel "no pressure" system that allows the unit to envelope the patient without undue shoulder squeeze found in other flexible stretcher.

Recommended Patient Height: 4'4" – 6'9"; Recommended Patient Weight: 100 – 300 lbs.
Includes waterproof carrying Pack. Dimensions: Length: 47"; Width: 32.5" Weight: 13.2 lbs (Stretcher only)

	Color
209220410	Orange
209220411	Black

STR II FULL BODY STRETCHER

Includes Integral Patient Lifting Harness

The STR II is a versatile envelope stretcher ideal for transport and rescue of patients in many vertical scenarios – Urban, Marine, Industrial, Mountain, Industrial, confined spaces, and other difficult access locations. Made with a Double Safety System protection for head and feet. Color coded strap system: Patient (Yellow), Closure (Black), Lifting (Blue). Integral patient harness works directly on patient or may be converted to secure a patient packaged on backboard. Automatic rescue strength locking buckles securing patient in the STR II. Features stainless steel "no pressure" system that allows the unit to envelope the patient without undue shoulder squeeze found in other flexible stretcher.

Recommended Patient Height: 4'6" – 6'9"; Recommended Patient Weight: 100 – 300 lbs.
Dimensions: Length: 95"; Width: 36" Weight: 18.75 lbs (Stretcher only)

	Color
209220390	Orange
209220391	Black



SLIX100 STRETCHER KIT FOR HORIZONTAL AND VERTICAL LIFTING

A robust, compact and lightweight stretcher. The flexible material has a smooth finish allows easy sliding and permits the stretcher to be rolled facilitate transport. No webbing passes under the stretcher giving a true smooth surface for dragging. Strong, continuous handles along the length of the stretcher allows it to be more easily maneuvered through tight, confined spaces by multiple rescuers. May be hauled horizontally or vertically. Includes Carry Bag. Made in U.K.

WLL 880 lbs.

2027191100



REEVES SLEEVE

Immobilizes Patients for Transport

A unique product that converts a full size backboard into a patient immobilization device to be used for vertical and horizontal lifting. Perfect device for confined space rescue because it fits over the backboard (not included). DOES NOT CAUSE FEET TO ANGLE OUTWARD as do popular plastic lifting devices. Sleeve material is a vinyl laminated nylon that meets Mil Spec C 4300 Type 1, Class 1 anti-fungal vinyl and is resistant to acids, alkalies, and liquids. Lifting straps are constructed from 6,000 lbf. Tensile Strength webbing. Reeves Sleeve II has extra webbing reinforcement for greater strength.

Color: Orange. Storage Dimensions: 24" x 12" x 9" Full Dimensions: 76" x 24" Weight: 16.85 lbs.

Note: This product, when used with a quality backboard, provides the best medical access of any confined space immobilization devices.

620401	Reeves Sleeve
620401S	Reeves Sleeve, Metal Buckles
620401R	Reeves Sleeve, Reinforced
620402	Reeves Sleeve II
20700049	Replacement Head/Chin Strap



REEVES SLEEVE DRAG VERSION

Tough, Low Friction Bottom

A special conversion of the traditional Reeves Sleeve that adds a special drag sheet. The sheet reduces drag and protects the sleeve in rough environments.

620403	Reeves Sleeve Drag Version	\$910.00
--------	----------------------------	----------



LSP HALF BACK™

A versatile short body immobilization board designed for suspected cervical/spinal injuries during confined space rescues. Leg straps support lower body during lifting. 6 handles. Closed cell foam interior and metal back stay.

Weight: 10.75 lbs.

2322720	LSP Half Back, Color Coded Straps
2322711	Vertical Lift Straps for LSP
2322716	Half Back Carrying Case



MILLER BODY SPLINT™

Complete with a full head and body restraint harness. Rigid foam core provides both strength and buoyancy (will float 250 lbs. in fresh water.) Split leg design.

2154700	Miller Body Splint
2154720016	Carrying Case

SPEC PAK™

Includes Horizontal Lifting Bridle

Unique Patient Packaging and Extrication System combines' backboard immobilization of a "Short Board" along with the suspension and support of a full body harness. The Spec Pak System utilizes an integrated polyethylene board along the back of the harness system to reduce wear and allow for a smooth sliding surface for confined space operations. Grab handles located on the sides and head of The Spec Pak aid rescuers during movement of patient through confined spaces. The Spec Pak System is very useful for any confined space operations where a vertical environment is encountered. Spec Pak is a fully certified lifting harness (ANSI Z359.1-1992), thus eliminating the need for a separate victim harness. Unique self-adjusting cervical restraint eliminates the problem associated with lifting patients vertically while secured to a rigid backboard. NEW head pad system helps prevent hyper-extension of cervical area. Spec Pak is only intended as a limited spinal immobilization system. Spec Pak must be used with proper spinal immobilization such as the use of a "Cervical Collar" where conditions and protocols dictate.

620410	Spec Pak
--------	----------





OREGON SPINE SPLINT II

Absolutely the best spinal immobilization / extraction device available. Preferred to K.E.D., XP-1, and LSP. It immobilizes the spine and the shoulders at the same time. When applied it allows easy access to the patient's chest or abdomen for treatment or diagnosis. The chest straps hold the patient more securely than other devices, but does not restrict breathing. It folds up extremely small to fit in its carrying bag. Non-absorbent materials for easy cleaning.

Weight: 9.1 lbs.

620500

Orange (SK-300-OR)



SKED® STRETCHER

The SKED® basic system includes the SKED® stretcher, Cordura™ backpack, horizontal and vertical lift systems, tow strap and webbing handles. Requires Backboard for proper patient immobilization. Excellent in rescues which require the unit to be dragged through a narrow space.

Weight: 16 lbs.

		Color
620415	Sked Stretcher, Complete (SK-200-OR)	Orange
620415C	Sked Stretcher, Cobra, Complete (SK-200-OR)	Orange
620420	Half Sked Patient Drag (SK-220)	
620450	Sked Flotation Kit (SK-600-OR)	
620452	Sked Rapid Deployment Conversion (SK-651-OR)	



HAZ-MAT PATIENT TRANSFER SYSTEM

Includes everything needed for a rapid evacuation of mass casualties in a haz-mat environment. Includes continuous loop shuttle rope for distances of 100', 150', and 200'. The system allows as many as 4 rescuers in Level A suits to load patients onto the shuttle. System includes: 12 HMD Sked Stretchers, Rescue Winch System, 2 Knot Passing Pulleys, 14 Carabiners, Accessory Cord, 8 Rope Grabs, and 100' Extension Cord w/ Reel. Hitch pin not included.

21172520

Patient Transfer System



SKED HAZ-MAT

A SKED designed for mass casualty and Haz-Mat Use. Complete with cut-in hand holds and disposable slings. Stretcher is easily decontaminated.

620416

Sked Haz-Mat (SK-250)

620417

Body Only (SK-251)

620418

Haz Mat Straps (SK-252)

620419

Deployment Case (SK-253)



SKED SIDE-RELEASE CONVERSION

Quick Connect/Quick Release

Skedco/Cobra side release buckles that meet the needs of securing a patient into a Sked® stretcher. Buckles rated at 3000 lbf. Durable and easy to use. With these buckles you will no longer have to weave the webbing through the buckles when packaging a patient. Patient packaging is often done in about half of the time as when using the original buckles.

2117208C

RUTH LEE

RESCUE TRAINING MANIKINS

Ruth Lee Ltd has designed and manufactured high quality rescue equipment and training manikins for over 35 years in the UK. They have partnered with Rescue Technology to bring their market leading success to the US. All the different have the same basic design, with an inner body weighted with aggregate to human proportions, held inside the outer carcass. The aggregate is distributed around the body in weighted packets in such a way that slumping of the weight is prevented, allowing the dummy to maintain its form during and after use. The three main types, Firehouse (FH), Water Rescue (WR) and Duty Range (DR), all use different materials. The Duty Range replaces the original General Purpose manikins and now uses a durable Polyester fabric carcass and polyurethane foam; the FH models are made using Nomex blend material. The WR manikins use durable polyester fabric, Nylon mesh and non absorbent foam. All manikins apart from the FH models are



*Features may vary on manikin models.



FIRE & RESCUE - GEN2 TRAINING MANIKINS

Now with high strength polyester fabric shell

Rugged, realistic in size, weight distribution and handling characteristics. Manufactured using a flexible inner core, a high strength polyester outer shell, and protective overall. The inner core is weighted to human proportions using 4.4 lb. weight packets. For structural integrity, the packets are sewn to a nylon "inner dummy" with all the body parts (arms, legs, chest, etc.) held in place with webbing. The outer layer is manufactured of durable, abrasion resistant polyester fabric that outwears the canvas shells used in competing brands.. All seams are double stitched and reinforced with webbing for improved abrasion resistance. The included protective coveralls protect the manikin from dirt and abrasion and are reinforced with high strength webbing in high stress areas. All manikins 44 lbs and up are supplied with lug sole boots that are secured to the manikin. Optional weight vest fits underneath the coverall and allows weight to be added or removed as needed to achieve the desired Manikin weight.

		Weight	Height
2395001005	Infant	11 lbs.	2' 3"
2395001010	Toddler	22 lbs.	2' 10"
2395001020	Youth	44 lbs.	4' 3"
2395001020A	Extra Light Adult	44 lbs.	5' 11"
2395001030	Light Adult	66 lbs.	5' 11"
2395001050	Standard Adult	110 lbs.	5' 11"
2395001070	Heavy Adult	154 lbs.	5' 11"
2395001080	Heavy Adult	176 lbs.	5' 11"
2395001090	Extra Heavy Adult	198 lbs.	5' 11"
2395006100	Drop Test, Adult	220 lbs.	5' 11"

Replacement Reinforced Coveralls	
2395050105	Repl. Coverall - Infant
2395050110	Repl. Coverall - Toddler
2395050120	Repl. Coverall - Youth
2395050170	Repl. Coverall - Adult
23959701	Replacement Boots
23959702	Replacement Boot Strap



SHOUTBOX EXTRICATION-GEN2 MANIKIN

Manikin PLUS User Recordable Talk Unit

We have combined our Multi-Trauma Manikin and the Shoutbox manikin voice box to create an advanced extrication training manikin. The Multi-Trauma manikin is clothed in a special reinforced coverall (not shown) and will allow simulation of full and partial amputations of the right arm and right lower extremity. The manikin also has a thoracic impalement feature. The include Shoutbox manikin voice box adds to the realism with looping or sound activated victim response. The Ruth Lee Manikins give the most accurate representation of a trapped victim. All anatomical proportions are correct in length, size and weight.

	Size	Weight
239586030	Adult	66 lbs.
239586050	Adult	110 lbs.



RUTH LEE SHOUT BOX

The ShoutBox™ can be used in conjunction with any Ruth Lee Adult Training Manikin with an anatomically shaped head and will radically change the way in which rescue training is carried out. The ShoutBox™ is an interactive voice recorder which allows the instructor to record a message specific to the day's training exercise. For example, in a search and rescue exercise, the instructor can have the manikin call out a pre-recorded message to rescuers or make coughing sounds to alert the rescuers of its presence. The ShoutBox can emit sounds in a loop (with user-selectable repeat intervals) or have the message play by sound activation. The ShoutBox™ comes complete with hood with mesh front to avoid distortion of sound and carries CE certification. Fits adult-sized General Purpose, Haz-Mat and Multi-Trauma Manikins. Manikin not included.

23959510	ShoutBox™ Kit (ShoutBox and Hood)
23959511	ShoutBox™ Only
23959515	ShoutBox™ Hood

FIREHOUSE-GEN2 TRAINING MANIKIN

All New Heat Resistant Design

The Fire House Manikins demonstrate a good balance between temperature and abrasion resistance. The Fire House manikin is perfect for fire and general training. The manikin carcass is constructed using heavy duty canvas, reinforced with 38mm Nomex webbing as opposed to the polypropylene webbing found on the general purpose range – standard Polypropylene webbing will go brittle and melt at the high temperatures this manikin is designed to withstand. The protective coveralls are constructed using a Nomex blend material which offers good protection against high temperatures - it is permanently non-flammable and most commonly used in protective clothing to protect against heat and flames. The protective coveralls are also reinforced using Nomex webbing to improve the abrasion resistance and strength – the overalls are fitted using 20mm Kevlar ties, as the standard Velcro fastening melt at these high temperatures. The ends of the arms, which have been identified as a high stress area, are reinforced with 5mm leather to provide extra protection. The Fire House Manikins are designed to withstand temperatures of 280-320°F (140-160°C), the average temperature at floor height for hot fire cell training and only starts to 'fail' at temperatures in excess of 350°F (180°C).



SHOUTBOX DUTY RANGE-GEN2 MANIKIN

Manikin PLUS User Recordable Talk Unit

The Shoutbox GP Manikin combines the original Ruth Lee General Purpose Manikin with the Shoutbox manikin voice box. It give an economical solution to interactive training.

		Weight
239581020	Youth	44 lbs.
239581020A	Adult	44 lbs.
239581030	Adult	66 lbs.
239581050	Adult	110 lbs.

		Weight
2395005005	Infant	11 lbs.
2395005010	Toddler	22 lbs.
2395005020	Youth	44 lbs.
2395005020A	Adult	44 lbs.
2395005030	Adult	66 lbs.
2395005050	Adult	110 lbs.
2395005070	Adult	154 lbs.
2395050505	FH Coveralls, Youth	
23959850	FH Coveralls, Adult	





RUTH LEE CONSCIOUS CASUALTY MANIKIN

After two years of development, several prototypes and extensive testing Ruth Lee created the Conscious Casualty Manikin. It is designed to behave like a swimmer with arms upraised making it the ideal manikin for training with boats and Personal Watercraft. Bright orange overalls and SOLAS reflective tape on the head make the manikins very conspicuous in open water. Polyethylene strips running from the shoulders to the knees allow flexibility in and out of the water but prevent the manikin from being too 'floppy'. The Conscious Casualty Manikin is 5 ft tall to be more manageable for a range of rescuers. In water weight is

44 lbs. Out of water weight when wet is around 88 lbs. Center of gravity is low to improve stability in rough water. Includes a hanging loop for storage. Protective overalls are user replaceable and greatly extend the life of the manikin.



MANIKIN FACE MASK

A realistic slip-on facemask that makes any adult training manikin look much more lifelike. Available in standard or wig versions. Velcro opening for easy donning.

23959505	Facemask, Standard
23959506	Facemask ,Wig



BERNARD" K-9 MANIKIN

After many requests, the folks at Ruth Lee created the "Bernard" K-9 Manikin to help rescuers deal with either K-9 victims or Working Dogs in the vertical environment. "Bernard" fits into K-9 harnesses for medium sized dogs (terriers, Malinois, etc.).

2395021001	Weight
	22 lbs

2395018020



LIGATURE AIRWAY MANIKIN

Tragically, death by suicide is an increasing problem in society. Institutions within the fields of Mental Health Care, Learning Disability, Police, Prisons, Care Homes and other high risk environments who face and need to manage suicides and self-harm on a regular basis. They must equip their staff with the right training to safely and sensitively manage such scenarios, including the use of a hook knife to properly release a ligature. The manikin has anatomical landmarks including the sternum, rib cage, and substernal notch. The trainer also contains teeth, uvula, vocal cords, glottis, epiglottis, larynx, arytenoid cartilage, trachea, oesophagus, inflatable lungs and stomach. It allows for placement of a nasogastric tube and accepts Combitube®, E.O.A., E.G.T.A., P.T.L. and i-gel® airways. The Ligature Manikin also features realistic knee joints promoting correct manual handling techniques including preservation of the C-spine. A special D-ring feature enables easy suspension without damaging the manikin. Height: 5'10" Weight: 55 lbs. Stock number: 2395021025"

2395021025	Weight	Height
	55 lbs.	5'10"



2395022055



CASUALTY EVACUATION MANIKIN

"A new manikin with special add-on features making it excellent for Physical training and evaluation. While the Casualty Evacuation Manikin was designed specifically for the UK Fire Fighter Recruitment Test and the CFOA FireFit Role Based Fitness Test, it work well for agencies outside of the UK as well. Constructed in the same flame retardant Polyester used in Police ballistic/stab vests, which typically has 4 times the strength and abrasion resistance of 16oz canvas or P.V.C (the materials previously used) – making the manikins even stronger than before.

Features & Benefits:

- Anatomically correct weight distribution gives the 'feel' of an unconscious casualty.
- Strong webbing loop allows easy handling, hauling aloft, storage and suspension for drying.
- Supplied complete with leg protectors making it perfect for drag tests.
- Water repellent material, making it suitable for wet or foul conditions.
- Soft body joints eliminate the risk of pinch welts and bruising; common injuries when using plastic bodied manikins.
- Also comes complete with boots, which are easily replaced if damaged.

2395022055	Weight
	121 lbs.



DIVE RESCUE / RECOVERY-GEN2 MANIKIN

Designed for water victim recovery training.

Constructed using a reinforced, heavy-duty Nylon mesh for the carcass with non-absorbent closed cell foam for buoyancy. The mesh allows the water to flood out of the body as it is being recovered and also allows better ventilation when the manikin hung up to dry. Polypropylene strips running from the shoulder area to the knee joint allow flexibility in and out of the water, but do not allow the dummy to bend in half when using stretchers or recovery devices like the Jacob's Cradle. The addition of the facemask and wig gives a realistic look and feel and aids the identification of a human body in poor visibility. The adult manikin has a dry weight of 106 lbs. (48 kg) out of the water and will sink quickly to the desired position. The closed cell foam adds to the buoyancy, giving a weight of 22 lbs (10 kg) in the water providing a realistic training weight for a body in the water. Supplied complete with user-replaceable boots and protective overalls to protect the manikin.

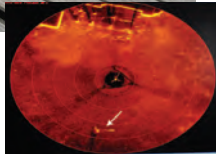

Sonar image of Recovery manikin

2395019010	Toddler, 22 lbs.	2' 10"
2395019030	Youth, 66 lbs.	4' 3"
2395019050	Adult, 110 lbs.	5' 11"



RUTH LEE BARIATRIC-GEN2 TRAINING MANIKIN

400 lbs of Realistic Flabby Performance

Designed to achieve a 'fluidity of movement' that simulates an obese patient. The Large Gentleman is based around a 220 lb. General Purpose Manikin, the extra bulk is built up with several weighted layers separated by Nylon coated padding. Rather than just adding a 180 lb. 'lump', we have distributed the extra weight around the body in 170 x 1 lb. packets of steel shot (a very time consuming process!). The Nylon coating on the padding allows the different layers to slip and slide over each other creating a real feeling of 'flabby skin'. Includes Reinforced Coveralls and Boots AND Drag Sheet.

Weight: 198 - 595 lbs.; Approximate Height: 5'11"

Ships via Motor Freight Only.

		Weight
2395008090	Large Gentleman	198 lbs.
2395008180	Larger Gentleman	400 lbs.
2395008270	Enormous ED	595 lbs.
29963144	Bariatric Drag Sheet	
2395008905	Bariatric Pajamas	



OSCAR MAN OVERBOARD-GEN2 MANIKIN

Ruth Lee Model MK2

Built to the same tough construction standard as the General Use Manikin, the water rescue is built to simulate an unconscious victim in the water, floating at an angle of 45 degrees with just the head and shoulders above the water. The head is color-coded with a yellow "face". Strong plastic strips in the manikin run from the shoulders to the knee and maintain overall flexibility but don't allow the manikin to "flop" in half. The outer carcass is constructed of heavy duty open mesh reinforced with webbing. SAR Hoody may be added to the standard adult Man Overboard manikin to decrease visibility. Thermal Imaging Hood allows the user to put 4 small hand warmers into the slots for thermal imaging practice with the Man overboard Manikins.



Manikin Hoodie

Adult: 5'11" Youth: 4'3"

		Size	Color
2395015005	Infant	11 lbs.	Orange
2395015010	Toddler	17.6 lbs.	Orange
2395015020	Youth	44 lbs.	Orange
2395015021	Youth	44 lbs.	Black
2395015040	Adult	88 lbs.	Orange
2395015041	Adult	88 lbs.	Black
23952049	SAR Hoody for Man Overboard Manikin		
23959693	Thermal Imaging Mesh Hood, Adult		
23959691	Standard Mesh Hood		

See our website for Replacement Coveralls



TECH RESCUE-GEN2 CPR MANIKIN

Allows for realistic body-weight CPR training in more difficult situations (i.e. confined spaces or with the manikin trapped under a vehicle or collapsed building etc.) This manikin takes CPR / Medical training out of the clean, classroom environment and integrates it into a realistic technical rescue training situation. Can be placed into confined spaces, trapped under a vehicle or train, or under concrete or wooden beams etc; These are situations where rescuers might actually come across casualties, where they may not be able to move them into a 'convenient' position to carry out CPR. This manikin adds an additional dimension to technical rescue and CPR training. The torso isn't actually fixed to the manikin and can simply be lifted out for cleaning or maintenance. The chest cavity of the manikin is also padded to protect the CPR torso, when used in difficult situations. The torso is constructed of soft, realistic vinyl plastic over polyurethane foam. The manikin features the following:

- Long torso for realistic abdominal thrusts.
- Realistic head tilt and chin lift for opening airway.
- Anatomical landmarks including sternum and ribcage plus substernal notch.
- Easily manipulated airway to simulate airway obstruction or choking situations.

	Size	Weight
2395007201	Adult	44 lbs.
2395007501	Adult	110 lbs.



WATER-FILLABLE BARIATRIC SUIT

For Ruth Lee Adult Manikins

Light enough for one person to carry into position and set up the training scenario. Simply place the suit over your existing manikin, attach a hosepipe and fill it up with water to achieve the required weight. Up to 330 lbs of additional weight can be added using water. This process takes 15-20 mins from arrival at the venue, to having the manikin set up to train with (depending on water pressure at your venue). When the training is over, use the special valves and a hosepipe to empty the water! Includes bag for easy Storage. Once filled, these manikins are designed to be carried by a team of at least 4-6 people. Includes Soft Boots.



FEATURES & BENEFITS

- Specially designed suit converts any adult Ruth Lee Duty Range manikin into a Bariatric Manikin.
- Innovative design allows one person to carry the equipment needed and position the 'manikin' in place.
- The suit is constructed from an extremely high specification Trilaminatate of Cordura /Butyl/ Polyester fabric. This combination makes it fully waterproof, but more importantly, very hard-wearing and flexible.
- All seams are triple-stitched and taped by hand with 38 mm Aquatape for extra security against leakage.
- British manufactured and handmade.
- Must be moved using a bariatric carry sheet. Do not drag manikin / bariatric suit. Fabric is not indestructible.
- Optional Pyjamas and Carrying Sheet (WLL 1320 lbs.)

2395008901



WARNING

The Water-Fillable Bariatric Suit is for use on Ruth Lee Manikins. **NOT FOR HUMAN USE.** Serious injury or death may occur if used on humans.

Technical rescue and safety is potentially hazardous. Any person using equipment sold by RESCUE TECHNOLOGY in any manner is personally responsible for learning the proper techniques involved, and assumes all risks and accepts full and complete responsibility for any and all damages or injury of any kind, including death, which may result from the use of any RESCUE TECHNOLOGY equipment



RUTH LEE FIRE MARSHAL MANIKIN

This Fire Marshal Manikin allows you to teach 'knock down' drills using fire blankets or portable fire extinguishers when responding to somebody on fire. This manikin can also be used to demonstrate the hazards associated with wearing loose and flammable clothing when near an open flame and to demonstrate methods of extinguishing clothing using a smothering technique - it can bring real excitement to your courses to keep trainees interested and engaged. Optional accessories include: Support stand and Protective vest.

FEATURES & BENEFITS

- The Fire Marshal Manikin is extremely robust, but applying the gel to the protective vest will greatly extend the life of the manikin.
- The chest section of the manikin can be set alight and will withstand temperatures up to + 700° C with no damage.
- Can be used with or without the support stand - the stand has a semi circular base to allow for 'knock down' drills. (Please note that this stand is only suitable for the Fire Marshal manikin)

2395013014	Fire Marshal Manikin
2395013901	Support Stand
2395013902	Protective Vest
239501399201	Fire Gel, Low Smoke, 20 kg
239501399041	Fire Gel, Low Smoke, 4 kg
239501399014	Fire Gel, Low Smoke, 4 x 1 kg



URBAN SEARCH & RESCUE MANIKINS

Designed specifically for Urban Search & Rescue (USAR) training but this manikin has many other applications. Now constructed in the same flame retardant Polyester used in Police ballistic/stab vests, which typically has 4 times the strength and abrasion resistance of 16oz canvas or P.V.C (the materials previously used) - making the manikins much stronger than before. Same construction as the best-selling Fire & Rescue Manikins. The Polyester fabric is waterproof, making it suitable for wet or foul scenarios such as Hazmat/ CBRN as it can be more easily cleaned and dried than canvas models. The USAR manikin is purpose-built to hold the included Shoutbox unit which provides the manikin with the power of speech. Can replay a personalized message of up to 60 seconds depending upon the selected interval setting. When using the Vox option, the Shoutbox will respond to the sound of a voice. Supplied with the 2 x AA batteries.

2395009030	Adult, 66 lbs.
2395009050	Adult, 110 lbs.
2395009070	Adult, 154 lbs.



Includes Coveralls & Boots



Simulates Full and Partial Amputation of Leg and Arm



OFFSHORE-GEN2 MANIKIN

Designed as an amalgamation of the HazMat and Man Overboard Rescue Manikin the Offshore Manikin is a versatile product designed for water and general rescue training on offshore platforms and vessels. The P.V.C carcass and increased weight make this model stronger and more suitable for simulating rescues from accommodation areas, engine rooms or drilling platforms - used in conjunction with the tough protective overalls, this model will withstand the rigours of general training.

While this manikin will float well in static water it is advisable to use some form of buoyancy aid in open seas or rough water. Weighing in at a respectable 60 kg when dry the offshore manikin is constructed using a P.V.C carcass with mesh to the ends of the arms and legs to aid drainage. As standard with any Ruth Lee Water Rescue manikin there is a polypropylene webbing loop on the back for hauling and hanging to dry as well as SOLAS reflective tape on the head. The

standard protective overalls are included. The Offshore manikin is supplied complete with protective coveralls, draining sturdy rubber boots; the boots help protect the legs if the manikin is dragged along metal gangways and corridors.

Height: 5' 11"

MULTI-TRAUMA-GEN2 EXTRICATION MANIKIN

The Multi-Trauma Rescue Manikin evolved from the Blast and Impaled Victim manikin to combine all the features of these manikin in one product. Additionally, the head has been redesigned to allow the fitting of an extrication collar. So now you have in one manikin a General Purpose rescue manikin that can also simulate an amputated arm and leg, an impaled torso and a suspect neck injury. The hole on the left of the torso allows a spike to be firmly held in place. The right arm and right leg are fully detachable to simulate an amputation, or by partially releasing the locking straps the limb can be weakly attached and will fall off if the rescuer does not correctly assess and support the injury. The manikin is supplied complete with sturdy boots that greatly protect the legs if the manikin is dragged along the ground, and are user-replaceable if badly damaged.

Height: 5' 11"

Multi-Trauma Training Manikin shown with C-Collar (not included), also Includes Coveralls (not shown).

	Weight
2395004030	66 lbs.
2395004050	110 lbs.
2395004070	154 lbs.
2395050470	Replacement Coveralls

	Weight
2395017060	Offshore, 132 lbs.
2395051760	Replacement Coveralls



WORKING AT HEIGHT MANIKIN

An extremely tough manikin for all Working at Height training.

Used globally by Special Rescue teams, Arborists, Health & Safety trainers, Industrial Rescue teams and many more. Similar in construction to the Duty Range manikins but utilizes closed cell foam to the trunk to provide greater rigidity and reduce 'slumping' when using a rescue harness. Tough Polypropylene plastic strips running from the shoulders to the knees (as in the Offshore model) prevents excessive flexing when used aloft. Anatomically correct weight distribution gives the 'feel' of an unconscious person - perfect for pole top or tower rescues. Realistic sizes and weights - will demonstrate the difficulties of dealing with an adult unconscious casualty.

Height: 5' 11"

		Weight
2395011030	Adult	66 lbs.
2395011050	Adult	110 lbs.
2395011070	Adult	154 lbs.



RUTH LEE MASS CASUALTY TRAINING MANIKIN

Perfect cost-effective choice for a large, multi-agency exercise were a large number of casualties/bodies are required to be seen but not necessarily rescued. Constructed in a lightweight water resistant polyester and filled with flame retardant foam pieces and is Strong enough to be buried under concrete or steel lintels with no damage. Clothing not included.

Height: 5' 11" tall (1.8m) Light Weight - 17.5 lbs. (11Kg)

2395014008



Removeable / Replaceable Wrist Protectors

RUTH LEE PRISONER SECURITY GEN2 MANIKIN

The latest addition to the Ruth Lee range is the 110 lb adult Handcuff training manikin. Anatomically correct, the Handcuff Manikin is ideally suited to police and prison services to train for the evacuation of restrained unconscious casualties in an emergency situation. Made in the same way as the Duty Range manikin, the Handcuff manikin has slimmer wrists to accommodate handcuffs. The wrists are reinforced with a heavy duty PVC to prevent damage and there is also a PVC removable cuff that will prolong the life of the manikin. Once this removable cuff has been damaged by handcuffs it is easily removed and replaced.

2395003050	Prisoner Security Manikin	110 lbs
2395003070	Prisoner Security Manikin	154 lbs
2395003090	Prisoner Security Manikin	198 lbs
23956159	Replacement Wristlet	



AVALANCHE MANIKIN

The Avalanche Manikin was developed after a request from Scottish Mountain Rescue. The standard manikins were too heavy to be able to carry up a mountain to set a training scenario for body recovery following an avalanche. The manikin is made from durable PVC and is filled with foam to give the bulk and firmness of a body while also being lightweight (22 lbs) and easy to maneuver. The manikin also comes complete with a backpack that enables the manikin to be folded in half and easily transported. Features the RECCO avalanche recovery system.

- Light Weight – 22 lbs (11Kg) • 6 ft tall (1.83m) • 'Spongy resistance' when probing • Secure pockets for Avalanche transceivers • Lifelike facial features with mouth cavity and balaclava • Water resistant and non-absorbent

2395010011

Avalanche Manikin



CASUALTY TRAINING ARMBANDS

Provides Identification of Injuries

MCI casualty Armbands for Training manikins or patients used in drills. Includes one each: Head, Arm, Leg, Neck, Back, Chest.

23959501

Arm Bands, set of 6



DRAG HARNESS FOR RESCUE MANIKIN

A Full Body Harness with added shoulder handles for use with the Training manikins. Fits all Adult Ruth Lee and Simulaids manikins.

718130

Manikin Drag Harness



TRAINING MANIKIN WEIGHT VEST

For Adult Training manikin

Special Low-Profile design fits underneath manikin coveralls. Quickly and securely fitted to manikin. Allows one manikin to do the work of many. Now, both heavy and lightweight training needs may be met with a single manikin. (Shown outside of coveralls for clarity).

*Nominal weight

23959215

Weight

15 lbs*

23959225

25 lbs.*

23959236

36 lbs.*



MANIKIN STORAGE BAG

A custom-designed bag to fit the youth - Heavy Adult Sized Ruth Lee Training Manikins. Features Heavy Duty PVC material and nylon straps. Includes shoulder straps and end lifting handles.

23959104

Storage Bag, Youth / Adult



MANIKIN DRAG PROTECTOR

These leg protectors protect the manikins when being dragged - particularly during Firefighter drag training. Constructed using tough, heavy duty nylon with a disposable Polypropylene plastic strip. The plastic strip is held in place with 4 heavy duty snap and will last for many exercises before needing to be replaced. Additional plastic strips can be bought in packs of 5. The leg protectors include a harness and two 'dragging' loops. It also include two loops to hold the manikins arms in place to prevent them dragging on the ground; polypropylene webbing and quick release buckles quickly and easily secure the leg protectors to the manikin.

23959310

Drag Protector, Complete

23959311

Replacement Protectors, set of 5



THERMAL IMAGING TRAINING VEST



Vest designed to aid in thermal imaging training. Low profile design fits underneath coveralls of Manikin. (Shown outside of coveralls for clarity).

23959301

Thermal Imaging Vest

23959303

Thermal Packs, Set of 2



TI RESCUE RANDY



Thermal Imaging Training Manikin

Ideal for rescue training in buildings or search and rescue in the field, Rescue Randy TI will stand out from the background thermal image. TI Rescue Randy has been tested in smoke and steam-filled spaces for firefighting environments, with demonstrated realistic simulation for rescue and extraction training.

Special heaters in the face and hands operate off of standard 110V or 220V power outlets and reaches desired temperature in 15 minutes. You can set the temperature you want on TI Rescue Randy and he will be visible on scanner for over 45 minutes unplugged. In real world environments, the manikin is not likely to be presented with the entire body or torso exposed for easy heat signature definition. Therefore, you should train with smaller presentations such as the head and hands.

Size: 55" x 27" x 13". Weight: 165 lbs.

240320165

Thermal Image Randy

240321482

Thermal Image Baby

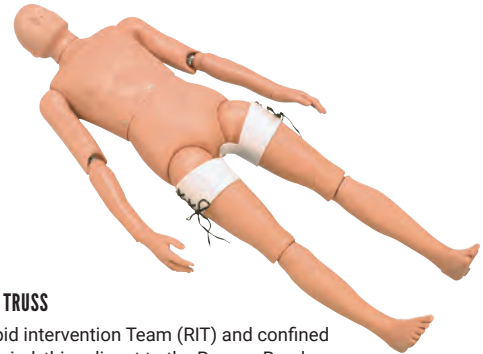

RAPID INTERVENTION TRUSS

Designed with Rapid intervention Team (RIT) and confined space rescues in mind, this adjunct to the Rescue Randy eliminates strap pressure applied to the groin area of the Randy. Harness or waist straps that are passed through the groin during exercises will not hinder the structure of the manikin skeleton, which causes degradation of the pelvis. Use this inexpensive product to protect the investment you made in your Rescue Randy.

21541479

Randy Intervention Truss

FLEXIBLE RESCUE RANDY

This standard-sized Rescue Randy unit has been developed especially for the aerospace industry and wing tank fuel cell rescue training, but it can be utilized in any confined space rescue. The waist flexes and the head twists to allow positioning of the manikin in tight spots. Flexible 5 ft. 5" Rescue Randy.

Size: 50" x 21" x 12" Shipping Weight: 60 lbs.



21542710

Flexible Rescue Randy

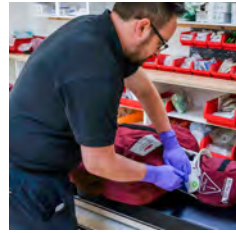

REPLACEMENT HEAD COVER

Sometimes your head just wears out. The Ruth Lee Replacement head covers extend the life of your manikins. Each cover is printed with the manikin weight. Easily slips on and closes with velcro.

	Weight
2395901050	110 lbs. (50 kg.)
2395901070	154 lbs. (70 kg.)
2395901090	198 lbs. (90 kg.)
2395901100	220 lbs. (100 kg.)

PATIENT HANDLING MANIKIN

A versatile manikin for all Health & Safety training within the Hospital and Care sector, including: early mobilization, emergency evacuation and working with lifting/transfer/evacuation equipment and general moving and handling exercises. Help your staff avoid the risks - train them to avoid the back injuries associated with unsafe, high risk moves by training with these realistic 'patients'. Now constructed in Polyester: conforms to BS EN ISO 6330), OEKO-TEX® Standard 100 and ISO 17050-1 - the new material is tough, safe to handle and very easy to clean. Anatomically correct weight distribution gives the 'feel' of a real patient/client - adult size and 'real world' weight for realistic training. The Patient Handling manikins totally eliminate the risk of the pinching associated with the joints of the plastic bodied manikins. Supplied with washable, maroon Polyester overalls.

	Size	Weight	Height
2395025020	Youth	44 lbs.	4'3"
2395025030	Adult	66 lbs.	5'11"
2395025050	Adult	110 lbs.	5'11"

FULL BODY AIRWAY MANIKIN

Airway Management training is usually carried out in a well-lit, carpeted classroom with plenty of space - how would your staff manage in a confined space or other difficult circumstances such as a road traffic collision (RTC) or if the manikin was trapped by the legs! Would they even be expecting to carry out Airway Management outside of a classroom? If you introduced this manikin into a routine training exercise what effect would it have - it would certainly make them stop and think and would definitely test their preparedness! The Full Body Airway Management manikin features the Simulaids Adult Airway Management torso. The Airway Management torso is not fixed and can easily be removed for cleaning. A padded jacket is supplied to protect the torso and to aid installation and removal from the carcass. Adult sized at 1.8m for realistic training. Supplied with replaceable, washable protective overalls. Supplied in a tough storage/carrying bag, making storing and handling the manikin far easier - they also protect and keep the manikins clean when not in use. The Simulaid torso features anatomical landmarks including the sternum, rib cage, and substernal notch. The torso also contains teeth, uvula, vocal cords, glottis, epiglottis, larynx, arytenoid cartilage, trachea, esophagus, and inflatable lungs and stomach whilst allowing nasogastric tube placement and accepts Combitube®, E.O.A., E.G.T.A., P.T.L. and i-gel airways.



		Weight	Height
2395024020	Adult	44 lbs.	5'11"
2395024050	Adult	110 lbs.	5'11"



RESCUE RANDY

Official Manikin of the Firefighter Combat Challenge

Molded of durable vinyl plastic. Built with 4,200 lbf. test plastic coated cables. Articulated Joints. Weight distribution according to human weight distribution chart. Used by U.S. Military, Fire and Police Departments, Safety Teams, and Emergency personnel for rescue and extrication. Ideal for Tower, Confined Space and Trench Rescue.

			Weight	Height
21544175	Rescue Randy IAFF	#1475	165 lbs.	6' 1"
21544165	Rescue Randy Combat Challenge	#1435	165 lbs.	6' 1"
21544145	Rescue Randy Combat Challenge	#1434	145 lbs.	6' 1"
21545200	Rescue Randy, Large Body	#1437	200 lbs.	6' 1"
21545175	Rescue Randy, Large Body	#1436	175 lbs.	6' 1"
21545125	Rescue Randy, Large Body	#1433	125 lbs.	6' 1"
21545165	Rescue Randy, Standard Body	#1345	165 lbs.	5' 5"
24031344	Rescue Randy, Standard Body	#1344	145 lbs.	5' 5"
21544105	Rescue Randy, Standard Body	#1335	105 lbs.	5' 5"
21544055	Rescue Randy, Standard Body	#1338	55 lbs.	5' 5"
21541355	Rescue Jennifer	#1355	16 lbs.	4'
21541355R	Rescue Jennifer II	#1355S	38 lbs.	4'
21542094	Storage Bag, Combat Challenge	#2094		
21543100	Storage Bag, Rescue Jennifer	#3100		

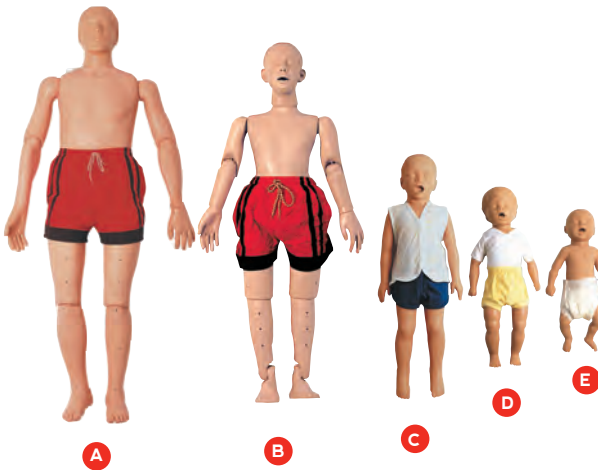

WATER RESCUE TRAINING MANIKIN

Used by the U.S. Coast Guard, Sheriff's Departments, Lifeguard Trainers and Emergency Personnel for both on water and in water rescue and retrieval. Manufactured of durable vinyl plastic with rust resistant steel skeleton (adult and adolescent models). Articulated joints on Adult and Adolescent. When filled with water manikin will submerge to neck. Add an additional 5 - 10 lb. weight (not supplied) to sink.



COMBAT CHALLENGE KID

Challenging children creates character. Put your kids to the test with this down sized version for the Fire Fighters Combat Challenge, kid style.



24031460

Combat Challenge Kid

			Weight	Height
A. 21541350	Rescue Cathy, Infant	Model# 1350	5 lbs.	20"
B. 21541352	Rescue Billy, 6 - 9 Month	Model# 1352	7 lbs.	25"
C. 21541351	Rescue Timmy, 3 Year Old	Model# 1351	10 lbs.	32"
D. 21541327	Adolescent	Model# 1327	22 lbs.	4' 0"
E. 21541326	Adult	Model# 1326	52 lbs.	5' 5"



SIMULAIDS / I.A.F.F 50 LB. TRAINING WEIGHT VEST

A specially designed (with the assistance of the I.A.F.F.) weight vest to aid in firefighter physical ability testing. The 50 lb. vest simulates the weight of protective clothing and SCBA. Pouches on shoulders accept additional 25 lbs of weight to simulate hose bundle. New design offers better fit and greater comfort for firefighter.

	Size
21541118	Small
21541120	Medium/Large
21541125	XLarge
21541000	Extra Shoulder Wgts, 25lbs.



RESCUE RANDY HARNESS

Moving large rescue manikins of any weight is a challenge. The Fire Fighter Combat Challenge staff developed this Rescue Randy harness to move the manikins back to the starting position. Constructed of 2" nylon webbing, the harness makes grabbing hold of manikins and the arms a simple process. Use the harness to handle manikins in your day-to-day operations. DO NOT USE the harness for hoisting, rescue operations, or any victim use.

24031470

Rescue Randy Harness

EQUIPMENT BAGS & PACKS

STOWABLE PADDED SHOULDER STRAPS

RescueTECH Shoulder Pads are produced with the highest quality structural webbing, soft and supportive foam, and breathable padding. The system stows in an integral compartment to keep the straps secure during storage; yet are easy to deploy when needed.



USAR-TECH ROPE & EQUIPMENT PACK

A full backpack style equipment storage/carrier. Features a rope bag section with room for 200 ft. of 1/2" ACCESS Lifeline PLUS space for a pre-rig rescue system (or a single 300' length of ACCESS Lifeline). This feature is easily accessible without opening the main compartment. The main compartment features RescueTECH's exclusive "expanding compartment" storage system. The system effectively doubles the storage space for webbing, slings, and rope guards by placing a divider in the main compartment. Adjustable Shoulder and waist straps will accommodate all rescuers. Waist pads will actually expand to fit larger waists. The semi-rigid internal frame supports gear. All straps may be tucked into special storage areas to prevent tangling with other equipment in the compartment. Manufactured in our Georgia facility from fabric made from Dupont Cordura Brand fibers.

Dimensions: 20"h x 18"w x 10"d.



Rope and Pre-Rig Accessible from exterior through our rapid access opening



First equipment section opens to show webbing, sling, and rope protector storage section



Opening the divider reveals additional sling storage and mesh compartments for hardware and rigging supplies.



Breathable Padded Shoulder strap.

Equipment not included

808320	Color	Orange
808326	Color	Blue
808324	Color	Red
808321	Color	Black



USAR-TECH II ROPE & EQUIPMENT PACK



An upgraded version of our original USAR-TECH Pack. We've added exterior zippered pouches to hold quickly needed equipment. The main compartment features RescueTECH's exclusive "expanding compartment" storage system. The system effectively doubles the storage space for webbing, slings, and rope guards by placing a divider in the main compartment. Adjustable Shoulder and waist straps. The semi-rigid internal frame supports gear. All straps may be tucked into special storage areas to prevent tangling with other equipment in the compartment. Manufactured in our Georgia facility. Available with 2 Interior storage styles - the original heavy duty mesh pouches or webbing equipment storage straps. Extremely durable YKK self-healing zippers and the highest quality side-release buckles for long term use. Holds 200' of 1/2" Access and pre-rig or 300' of 1/2" Access.

Outside Dimensions: 20" H x 22" W x 10" D Interior Panel: 19.5" H x 16.5" W



Mesh Pocket System: Original RescueTECH mesh equipment storage compartments.



Web Strap System: New webbing attachment panel with snap loops and equipment multiloop.



Exclusive Interior Expanding Storage may be detached to transport needed equipment

8083510	Mesh System	Color	Orange	8083520	Web System	Color	Orange
8083511	Mesh System	Color	Black	8083521	Web System	Color	Black
8083514	Mesh System	Color	Red	8083524	Web System	Color	Red
8083516	Mesh System	Color	Blue	8083526	Web System	Color	Blue



USAR-OPS ROPE & EQUIPMENT PACK

Now in 2 Sizes

A slightly smaller version of our popular USAR Rope and Equipment Pack, the Standard Rescue pack is durable and versatile. 3 interior mesh pockets securely hold small items. Outside 'slash' pockets and full width interior pockets give ample storage space for rope pads, slings and webbing. Horizontal strap system allows for attachment of pulleys and carabiners. Standard size holds 200 ft. of 1/2" ACCESS Lifeline and the Large holds up to 300 ft. rope. The USAR-OPS Pack also accommodates a pre-rigged system in rope section. Padded shoulder straps and waist strap are comfortable and easily stowed for bag storage.

Dimensions: Standard: 20"H x 16"W x 10"D Large: 24"H x 16"W x 10"D



Side View: Padded Shoulder Straps and Slash Pocket



Back View: Stowed Shoulder Straps.



Interior View: multiple mesh pouches, attachment straps and slot pocket.



Interior View: multiple mesh pouches, attachment straps and slot pocket.



Side View: Padded Shoulder Straps.



Back View: Stowed Shoulder Straps.

RESCUER EQUIPMENT PACK



A larger version of our Deluxe Equipment pack. Larger dimensions along with our Expanding Compartment Storage System gives rescuers extra room for needed equipment. 5 Mesh Pockets and 2 equipment loops. Padded stow-away shoulder straps. Self-Healing #10 industrial zipper.

Dimensions: 20"h x 16"w x 6"d.



	Description/Color	Cap.
8083134	Standard/Red	200'
8083136	Standard/Blue	200'
8083131	Standard/Black	200'

	Description/Color	Cap.
8083144	Large/Red	300'
8083146	Large/Blue	300'
8083141	Large/Black	300'

	Color
808344	Red
808346	Blue

BASIC ROPE & EQUIPMENT PACK

Single Storage Compartment

A Downsized version of our Deluxe Rope & Equipment Pack. The Basic Pack features the same looped webbing storage panel of our deluxe but in a single pack compartment design. The pack has a webbing carrying-handle and padded contour shoulder straps. A false back stores the shoulder straps when not in use. A front outside compartment is 16"H x 12"W x 6"D. The compartment has a sleeve for a rescue rack.

Weight: 2.2 lbs.

Equipment not included.



	Color
808200	Orange
808204	Red
808206	Blue

DELUXE ROPE & EQUIPMENT PACK



2 Compartments

An innovative pack designed to provide organized storage and convenient transport of rescue equipment. The main compartment (16"H x 12"W x 8"D) is fully padded with closed cell foam and has webbing loops to attach equipment. The pack has a webbing carrying-handle and padded contour shoulder straps. A false back stores the shoulder straps when not in use. A front outside compartment is 16"H x 12"W x 2"D. The main compartment has a sleeve for a rescue/rappel rack.

Weight: 2.2 lbs.

Equipment not included.





EQUIPMENT CACHE PACK

A handy storage pack for quickly needed rescue equipment. Padded sides, 4 Mesh Pockets, 8 equipment loops. Padded ergonomic shoulder straps store out of the way when not in use.

Dimensions: Closed: 23" x 12" x 4" Open: 23" x 24" x 2"

81133924

Equipment Cache Pack



EQUIPMENT SADDLE BAG ORGANIZER

Organizes Equipment

A modular accessory for our rope bags. Organizes technical gear into a convenient deployment package. Fits our medium, large, and extra-large size rope bags. The Saddle Organizer pockets are 8" x 4" x 20" with #10 zippers and a clear vinyl window for inventory lists. External Mesh Organizers for quickly needed items.

Weight: 1.25 lbs.

Rope Bag not included.

Color

808901	Equipment Saddle Bag Organizer	Black
808904	Equipment Saddle Bag Organizer	Red
808906	Equipment Saddle Bag Organizer	Blue



PACK ID LABELS

RescueTECH Packs are now produced with an attachment system for ID Patches. Starting in June 2010, the USAR-TECH, USAR-TECH II, USAR-OPS, and the Deluxe and Basic Rope & Equipment Packs can be used with our ID Patches. The high quality embroidered panels can identify function, ownership, and much more. Panels may be changed when packs are repurposed. Custom Patches are available, call for Pricing. Label size: 6" x 2".

Compatible with the following packs*:

USAR-TECH II • Deluxe Equipment • USAR-TECH • Basic Equipment • USAR-OPS • Rescuer Equipment

80899101	USAR
80899102	HAUL
80899103	MAIN
80899104	BELAY
80899105	RIGGING
80899106	RESCUE
80899107	CONFINED SPACE



EQUIPMENT CACHE RESCUE SET

A compact set of equipment suitable for rigging anchor, haul / lower, and belay systems.

• Equipment Cache Pack (5) • RescueTECH Technical Rescue Rigging Plate (1) • H.D. Load Release Strap (2) • Oval Steel Carabiner, Screwgate (3) • RescueTECH Rope Pad, Wide (1) • RescueTECH 2.5" PMP (5) • RescueTECH Rescue Rappel Rack (5) • OD50 Rescue Carabiner, Screwgate (10) • 1" H.D. Flat Webbing x 12' (YE) (2) • 1" H.D. Flat Webbing x 20' (OR) (2) • Presewn Prusik, 18" (YE) (5) • Presewn Prusik, 28" (RD) (2)



29983425

Equipment Cache Rescue Set



USAR TASK FORCE MEMBER PACK

A Multi-Use Personal Equipment Pack

Designed at the request of a Southeastern USAR Team, the pack keeps Helmet, Class III harness, Carabiners, Webbing, Gloves, Accessory Cord, Goggles and other personal gear ready for deployment. Manufactured of High Strength Polyester fabric. Padded on all sides to protect contents. "D" rings on end accept shoulder straps. We can even fill it with the equipment that you need.

Dimensions: 24 x 12 x 10"



Equipment Not Included

29962101
809790

USAR Member Pack
Shoulder Strap



PERSONAL GEAR BAG

A Multi-Use Personal Equipment Pack

Constructed with heavy-duty welded urethane bottom to prevent outside moisture from leaking in. The 1000-denier Cordura® upper closes with a heavy-duty zipper. Two generous zippered outside pockets and two large inside zippered mesh pockets help you keep smaller items organized. Comfortable carry handle, ergonomic shoulder strap, compression straps over the closure zipper and external D-rings and attachment loops round out the features of this great bag.

Dimensions: 25" x 15" x 14"

20843084
809790

Personal Gear Bag
Shoulder Strap



RESCUER GEAR BAG

We took the time to design a bag that a rescuer could keep personal gear ready to go. The main section has a zipper system that allow quick and full access to the contents. The large end pouch will hold an R3 Kiwi helmet, but can also be used for a change of clothes, harness, and other rescue items. The small end pouch works great for gloves, slings, etc. Side pockets hold other personal gear. A zippered see-through panel can be used for personal identification and allows the bag to be used and marked as a specific use rescue kit. Includes adjustable shoulder strap. Made in USA.

Dimensions: 24 x 10 x 10"

809741
809744

Black
Red



RT DUFFEL BAG

A traditional cylinder bag built with the same high quality and durability as all of our rope and equipment bags. Manufactured from our RescueTECH™ super tough fabric. Seams are double-stitched and taped for superior strength.

Large: 20" x 12"		Extra Large: 24" x 15"	
	Color		Color
8063140	Orange	8063150	Orange
8063141	Black	8063151	Black
8063144	Red	8063154	Red
8063146	Blue	8063156	Blue
		809790	Shoulder Strap, Adj



RIVER RESCUE DUFFEL

Organize your river hardware into one convenient duffel. This bag was designed with the rescue professional in mind while addressing the needs of the larger boating community. Manufactured from 600 denier polyester material. Full-length zipper provides quick access to gear. The 3" deep end compartment makes for easy organization of smaller gear. Sturdy handle and shoulder strap made with webbing that includes 3M® reflective tape makes the bag easy to find in low light situations.

Dimensions: 30" x 16" dia.

208430864

River Rescue Duffel



RT GEAR BAG

Heavy Duty Carrying Handles on Ends

A large Duffel design easily stores turnouts, helmet and boots. Great for all rescue personnel. The two-way wrap around zipper allows you to open bag all the way for easy access to contents. A large zipper pocket outside gives you extra storage for personal items, gloves, tools and goggles. Two inch webbed handles wrap completely around the bag to give extra support. Black version does not have the retroreflective stripe.

Dimensions: 12" x 16" x 24" Color: Red, Orange, Black Weight: 1.5 lbs.

	Color
809700	Orange
809704	Red
809701	Black



RT GEAR PACK

Stowaway Padded Shoulder Straps

Based on our popular Gear Bag design, we added shoulder straps to make it easier to move this pack around. Easily stores turnouts, helmet and boots. Great for all rescue personnel. Two-way wrap around zipper allows you to open bag all the way for easy access to contents. A large zipper pocket outside gives you extra storage for personal items, gloves, tools and goggles. Two inch webbed handles wrap completely around the bag to give extra support.

Dimensions: 12" x 16" x 24" Color: Red Weight: 1.5 lbs.

809844

Gear Pack



RESCUETECH PRE GEAR PACK

Deluxe Personal Rescue Equipment Pack

Our PRE Gear pack is designed to fit your needs for personal rescue equipment storage. Fully padded backpack shoulder and waist straps allow this pack to better distribute the weight between the shoulder and hips. Overall dimensions: 22" x 12" x 12".

Features: • Padded shoulder and waist Straps • Helmet pouch • Removeable equipment tarp (48" x 30") • Removeable Equipment Panel • Durable zippered openings at both ends • Zippered mesh side pockets • Interior Multi-loop gear straps

	Color
808401	Black
808404	Red



RIGGING BUCKET

Semi-Rigid Design

The newest bag from RescueTECH features semi-rigid sides to hold the bag open while loading rigging equipment and rope. Great for litter bridges and patient lashing as well as pre-rigged hauling kits. The main compartment has the same nylon fabric closure designed to keep the smallest items from escaping. 4 cordura pockets (with elastic closure) and 1 mesh side pocket for storing quickly needed equipment. Bottom is made from Ballistic Nylon for proven resistance to abrasion.

Dimensions: 12"high x 10" diameter.

803302

Rigging Bucket



LANYARD POUCH

For lanyards, personal escape rope, gloves, and miscellaneous small equipment. Constructed of Cordura® nylon with fold over hook and loop closure. Built-in loops fit belts up to 4" wide. Holds 40 feet of 3/8" or 75 feet of 7mm nylon tag line.

Dimensions: 8" x 5" x 3" Color: Black Weight: 2.4 oz.



	Color
800101	Black
800104	Red



NYLON STUFF SACK

Lightweight bags to stow small parts, equipment and personal gear. Manufactured of 200 den pack cloth with drawstring closure. Close with spring-loaded cordlock.

Color: Blue

	Size	Dimensions
805216	Small	10.5" x 4.5"
805316	Medium	12.5" x 5"

SWIFTWATER TEAM MEMBER DUFFLE

A tough, heavy-duty duffel. Sturdy 600 denier polyester forms the bottom and ends of the bag to protect your gear from sand and grit, and will endure years of abuse. High-strength mesh allows wet gear to dry, reducing mildew other moisture-related problems.

Color: Blue



Equipment not included

	Size	Dimensions
807231	Medium	24" x 12"
807241	Large	30" x 16"



DELUXE LANYARD POUCH



Great for search kits. A larger version of our popular Lanyard Pouch. The Deluxe Lanyard Pouch features a "hinged" lid with a "hook and loop" closure. Holds up to 80 ft. of 8mm cord.

Dimensions: 11" H x 7" W x 3" D Weight: 3 oz.

	Color
8001151	Black
8001150	Orange



MESH STUFF SACK

This unique and versatile stuff sack has all of the advantages of a mesh bag with the durability of a nylon bag. Great for organizing gear or storing anything that you need to see.

	Size	Dimensions
22821452	Small	5" x 8"
22821453	Medium	6.5" x 12"
22821454	Large	8" x 15"
22821455	XLarge	10" x 18"
22821456	XXLarge	18" x 27"



DRY BAG

Tough 21 oz. PVC fabric makes this bag the ideal storage system for rescue equipment. Bag handle and straps are welded to the bag with a heavy-duty double patch system. StormStrip Closure ensures the most waterproof seal on the market.

Dimensions: 25" x 14"

	Color
208429106	Blue
208429102	Yellow
208429104	Red



Equipment not included

WATER RESCUE TEAM MEMBER BAG

A new, versatile bag for both Surface and Dive Rescue Team Members. Manufactured with side panels of strong Vinyl Coated Nylon mesh, this bag allows for excellent content ventilation. Front panel, zippered mesh-backed pockets hold fins, gloves, snorkels, and other personal gear. Interior compartment is large enough to hold Drysuit, PFD, helmet, Boots, and throw bag. Side compression straps. Top handle and Shoulder Strap D rings.

Dimensions: 26" x 18" x 10"

807542	Rescue Team Member Bag
809790	Adjustable Shoulder Strap



(left) T2 Rescue Pack shown with optional "Rescue" label
(above) T2 Rescue Pack with stowable straps

T2 RESCUE PACK

Durable pack works well as a personal equipment pack or rescue systems pack. Originally developed as a component to one of our rescue kits, this pack will hold the hardware and 300' of 3/8" rope used in our Tower Rescue Set.

Medium: 20" x 12" x 4" (960 ci / 16 l) Large: 24" x 14" x 8" (2688 ci / 44 l)

- Heavy Duty PVC coated Fabric • Molded "suitcase" handle on side • Stowable shoulder straps
- Haul Loop / handle on top end • "Daisy Chain" Equipment Storage Loops • Lid closes with quick-lock buckle • Interior collar closure keeps equipment inside • Interior equipment tarp keeps contents separated and ready to use • Accepts RescueTECH Pack I.D. Labels

		Color	Size
8088144	T2 Rescue Pack, Med	Red	Medium
8088164	T2 Rescue Pack, Lg	Red	Large



BASIC SCBA MASK BAG

A basic, envelope-style SCBA mask Bag. Made from highest quality 300 x 600 PVC coated nylon fabric for durability and water resistance. Full width hook and loop fastener keeps the contents clean and ready for use. Steel ring allows firefighter to attach this bag to turnout gear with a simple key-ring carabiner. Fits most mask-regulator style SCBA Masks (Scott®, Interspiro®, etc.) Bags may be ordered with embroidery (25 unit minimum). Call for details.

Dimensions: 14" x 10" x 4" Color: Red

8321015	Basic Mask Bag
---------	----------------



DELUXE SCBA MASK BAG

An upgraded version of our original envelope-style Basic SCBA Mask Bag. We have added structural fire rated Scotchlite Retroreflective stripes to the bag to increase visibility. Shell made from the highest quality pvc coated nylon fabric for durability and water resistance. Full width hook and loop fastener keeps the contents clean and ready for use. Steel ring allows firefighter to attach this bag to turnout gear with a simple key-ring carabiner. Fits most mask-regulator style SCBA Masks (Scott, Interspiro, Ect.)

Colors: Red w/ Yellow/Silver Stripes; Yellow with Orange/Silver Stripes Dimensions: 14" x 10" x 4"

	Color
832102520	Yellow w/ OR/SI Stripes
832102542	Red w/ YE/SI Stripes



HALL COUNTY SCBA MASK BAG™

After many months of searching and evaluation, Hall County Fire (Georgia) decided upon this design to protect their SCBA masks. Made of durable 1000d Cordura™ fit their needs to a "T". Closed with a durable #10 Zipper instead of Velcro™ for a long service life. Hall County chose to line the interior with a smooth, coated 200 denier nylon fabric instead of a fleece material. Their evaluations concluded that while the fleece was soft, it trapped dirt and contaminant in the material and between the inner and outer layer. Features a bottom grommet for drainage and a hook and loop strip to attach name plates or accountability tags. A durable 1" wide nylon webbing loop allows the bag to be attached to turnout gear or hooks in the apparatus or equipment lockers.

Dimensions: 14" x 7"

		Color
8321014	Hall County SCBA Mask	Red
83210146	Hall County SCBA Mask	Blue

WATER RESCUE

GEAR & PERSONAL PROTECTION



Water Rescue, whether swiftwater, lake, ice or ocean, is demanding on the rescuer and equipment. We have put together an selection of equipment that will help teams meet the most difficult rescue head on. From wet and drysuits to helmets to throwbags, RescueTECH can fill you equipment requirements.



FIRST RESPONDER WATER RESCUE SET

Includes equipment most often required for swiftwater rescue classes.

- Universal Rescuer PFD (1) • ATB Rescue Boots (1 pair) • Lightweight Water Rescue Glove (1 pair) • Throwbag 70' (1) • Fox 40 Rescue Whistle (1) • River Rescue Short Knife (1) • Havoc Water Rescue Helmet (1)

Deluxe Set Includes (shown below in box): Water Rescue Team Member Bag (1) • Shredder Fins (1 pair)



29982001
29982002

Standard
Deluxe

BASIC WATER RESCUE SET

The bare minimum equipment to have while working around water.

- c-Vest PFD (1) • 3/8" Throwbag x 50 ft. (1) • River Rescue Short Knife (1) • Fox 40 Rescue Whistle (1)



Whistle Lanyard Not Included

29982003

Basic Water Rescue Set



WARNING

Technical rescue and safety is potentially hazardous. Any person using equipment sold by RESCUE TECHNOLOGY in any manner is personally responsible for learning the proper techniques involved, and assumes all risks and accepts full and complete responsibility for any and all damages or injury of any kind, including death, which may result from the use of any RESCUE TECHNOLOGY equipment



FORCE 6 RESCUER

The Force 6 is a high buoyancy (26lbs) vest for rescue professionals involved in boat and shore operations or medium to high risk swift water environments. Designed to meet the Personal Protective Equipment (PPE) needs of rescuers that face the challenges of moving water, these IRIA Certified vests are made of rugged, high visibility rip stop nylon and contain extra flotation to combat the reduced buoyancy effects of turbulent water.

An integrated structural harness and single piece over-the-shoulder foam design provide extra strength, structural integrity and body protection. Multiple adjustment points provide a secure fit that prevent ride up and a "live bait" quick release belt helps the rescuer to escape dangerous situations. Fast Tabs on both shoulders act as easy attachment points for accessories such as knives, scissors or strobe lights.

	Size
237011034	M/L
237011054	XL



NRS RAPID RESCUER

Type III/V PFD. With 22 lbs of flotation, adjustable to fit chest sizes from 30 to 58 inches, and all the features you will ever need in a rescue vest. Two huge front pockets stretch to hold anything from a GPS to a VHF. Three lash tabs on the front are great for a knife, whistle or anything else you need to keep handy. A rear D-ring, strobe holder, and tether attachment round out the attachment points on the front with a safety light stick holder on the back and reflective tape everywhere. 8 adjustment points to ensure a secure fit.

	Color/Item Description
208421492	Yellow
208421494	Red
20842163	Leg Straps, Pair

FORCE6 RESCUETEC PFD

The Best Equipment for the Worst Conditions

The RescueTec PFD is feature loaded including a removable left-front pocket, dual 1 1/2 in QR belts for throw bag attachment, waist belt with Gripp-Loc to prevent ride up. Adjustable shoulders with dual AustriaAlpin anodized aluminum buckles, Moulded extraction handle, 4 inch Velcro name attachment back-band, Heavy duty YKK front entry zipper, 12 elastic strap container bands, rear hydration attachment points, neoprene neck water damn, lapel strap tunnels, and reflective material on both the front and the back.



Shown with optional (right front pocket)

- UL listed and United States Coast Guard approved Type 5 Professional Swiftwater Rescue PFD
- 26 lbs. minimum flotation on both the S/M and L/XL models
- Gripp-Loc on waist belt to reduce ride up
- Left Front Pocket (optional)
- Swim Harness (Leg Straps) (optional)
- Right Front Pocket (optional)
- Shell Fabric - High tenacity 420 Denier Fabric

S/M (28" - 40" Chest) | L/XL (40" - 52" Chest) | Extrication Leash (Cowtail) (OPTIONAL ACCESSORY)

	Description	Color
24905216434	S/M	Red
24905216444	L/XL	Red
2490521604	Extrication Leash	
2490521648	Back Pocket	Black
2490521651	Front Left Pocket	Black
2490521654	Front Left Pocket	Red
2490521664	Front Right Pocket w/ Holster	Red



MUSTANG UNIVERSAL SWIFTWATER PFD

The Universal Swift Water Rescue Vest is a high buoyancy (25lbs) USCG approved Type V SAR PFD. Developed with ongoing feedback from the water rescue community to meet the Personal Protective Equipment (PPE) needs of rescue professionals. With an easy to adjust donning system and layered flotation foam, this vest provides a comfortable and secure fit, which improves operational performance both in and out of the water. Over 62 sq. in. of SOLAS tape with fluorescent yellow-green accents, 500 denier Cordura outer shell, MOLLE webbing on shoulders and back provides attachment points, Drag Handle, Durable harness with 2" webbing (730 lbs). All buckles, thread, stitch count, strap material and webbing are UL tested and certified. Quick donning with 7 adjustment tabs fits chest sizes from 32" - 52". Two large self-draining pockets on front. Quick-Release belt

	Color
2049150312	Black w/ Fluorescent Yellow



NRS ZEN RESCUE PFD

The Zen Rescue Life Jacket is a great choice for paddlers and guides who want a great fitting, comfortable PFD with swiftwater rescue features like a quick-release belt. Low profile with 17.5 pounds of flotation. 1.5" quick-release rescue belt with stainless steel attachment ring. Side entry for easy donning. Large front pocket. Carabiner and strobe attachment loops. Lash tab for rescue knife. US Coast Guard Certification, through testing by Underwriters Laboratories (UL).

	Color	
2084400302x	Small/Medium	Red, Charcoal, Black
2084400304x	Large/XLarge	Red, Charcoal, Black



UNIVERSAL HI-FLOAT

Universal Size high flotation vest

The U22 fits chest sizes from 30 - 56 inches. Its generous divided side pockets, external D-rings, and lash tabs allow attachment of multiple accessories. A 3 buckle closure system, generous reflective tape and 8 adjustment points create an excellent high-flotation option for water rescue and support teams.

Design Flotation: 23 lbs.

USCG Approved, UL Listed Type III PFD

	Color
350734	Red



CVEST PFD

cVest Life Jacket has lots of reflective tape and a cool mesh back that works great with high-back seats. Six pockets, including one for a radio, provide lots of handy storage. An accessory lash tab and lanyard loops on the front, plus a beacon loop on the back, give you even more options for outfitting this vest. Flotation is concentrated up front and behind the shoulders, with a mesh lower back that lets you recline, relax and stay cool. SOLAS reflective tape on front and back provides outstanding low-light visibility. Eight adjustment points ensure a snug, secure fit. Large arm openings allow for unobstructed movement while paddling or rowing.

Design flotation: 16.5 lbs.

	Size	Color		Size	Color
20844002822	SM/M	Lime	20844002824	SM/M	Red
20844002842	L/XL	Lime	20844002844	L/XL	Red
20844002862	XXL	Lime	20844002864	XXL	Red



TYPE V PFD

Universal Size high flotation vest

The Type V is a high flotation jacket with a universal fit that wraps easily around anyone's torso. Four front buckles make entry, exit and adjustment simple and quick. Universal Plus fits: 30" - 58" chest. Six side adjustments and two shoulder adjustments hold the PFD securely in place. Flotation collar helps keep your head above water while floating on your back.

Design Flotation: 25 lbs. Size: Fits 30" - 58" chest

	Color
208412520	Orange
208412522	Yellow
208412524	Red



K-9 PFD

Canine Flotation Device

Whether your dog jumps or falls in the water, the Canine Flotation Device (C.F.D.) keeps them on the surface. With a tough 1000-denier Cordura® shell and heavy-duty straps, the C.F.D. can take the worst your dog can dish out! With the flotation on the back, your dog stays cooler. Wide, soft under-straps for comfort; durable grab loop and leash ring for security. A zippered pocket for a leash, snacks, etc. Reflective safety tape for visibility.

	Size	Chest	Weight	Flotation
208421402	S	22"-28"	20-40 lbs.	3.4 lbs.
208421403	M	26"-30"	40-60 lbs.	4.9 lbs.
208421404	L	30"-37"	60-80 lbs.	6.4 lbs.
208421405	XL	36"-41"	> 80 lbs.	7.9 lbs.



WATER RESCUE TOW TETHER



Constructed of Heavy Duty Tubular Webbing, elastic, and steel ring. One end has a 2" ring to attach to the waist strap of Rescue PFD's. The other end is attached to a lightweight non-locking aluminum carabiner.

351101	Short Tether (35" Max)
351105	Long Tether (54" Max)



LONG TOW TETHER, AUTOLOCKING



Constructed of Heavy Duty Tubular Webbing, elastic, and steel ring. One end has a 2" ring to attach to the waist strap of Rescue PFD's. The other end is attached to our Forged Aluminum Autolocking Snap with eye for extra security.

351205	Long Tow Tether, Autolocking
--------	------------------------------



JUMBO MESH PFD BAG

The Mesh PFD Bag makes it easy to transport and store your damp and difficult-to-carry gear. The top of this bag is made with the same 2-1/2" square mesh netting so that everything inside dries quickly. The bottom is 500 denier PVC for durability. Two sturdy handles and a quick-cinch draw cord opening allow you to pick up and go. Room enough for all your friends' gear, too. Holds up to 18 PFDs.

Dimensions: 40" W x 40" L x 30" H

20843094	Jumbo Mesh PFD Bag
----------	--------------------



DELUXE MESH PFD BAG



Made for storage and transporting PFD's, the Deluxe Mesh PFD Bag is made from polyurethane coated mesh. The bottom is durable PVC coated nylon mesh for durability. Two sturdy handles are included and makes this bag extremely portable. Holds up to 10 Full sized PFDs(not included).

Dimensions: 35" L x 24" W x 18" H

Equipment not included

8063282	Deluxe Mesh PFD Bag
---------	---------------------

RESCUETECH THROW BAGS

Complete with Throwline and Ready to Use

Our Water Rescue Throwbags have been completely redesigned to give more features and make them easier to use. All bags utilize our Progressive Sewing Technology to give greater strength and resistance to abrasion. All ropes float - even when wet.

All of our bags feature:

- Double Stitched Seams • Reinforced Bottom Seams • Quick-Adjust Bucket Handle • Drawstring with Durable Cord-Lock • Drainage Grommets



STANDARD WATER RESCUE THROW BAG

Standard bags are manufactured with a urethane-coated 400 Denier water-resistant nylon for superior abrasion resistance.



		Length	Strength	Rating	Weight
598301050	3/8" Pro-Poly	50'	2,960 lbf.	Throwline	1.8 lbs.
598301075	3/8" Pro-Poly	75'	2,960 lbf.	Throwline	2.7 lbs.
598301100	3/8" Pro-Poly	100'	2,960 lbf.	Throwline	3.4 lbs.
598302050	3/8" Standard Poly	50'	1,900 lbf.		1.25 lbs.
598302075	3/8" Standard Poly	75'	1,900 lbf.		2.0 lbs.
598302100	3/8" Standard Poly	100'	1,900 lbf.		2.3 lbs.
598303050	8mm NFPA	50'	4,300 lbf.	Throwline	1.2 lbs.
598303075	8mm NFPA	75'	4,300 lbf.	Throwline	1.7 lbs.
598303100	8mm NFPA	100'	4,300 lbf.	Throwline	2.3 lbs.



DELUXE WATER RESCUE THROW BAG



The Technical bags give the rescuer a top of the line throwbag. Manufactured of 1000 denier Cordura in the bottom end and 400 denier in the sides and open end. The "Tech" bag also features Reflexite retro-reflective trim and elastic lightstick holders.

(Lightstick not included.)

		Length	Strength	Rating	Weight
598311050	3/8" Pro-Poly	50'	3,500 lbf.	Throwline	1.95 lbs.
598311075	3/8" Pro-Poly	75'	3,500 lbf.	Throwline	2.4 lbs.
598312050	3/8" Standard Pro-Poly	50'	1,900 lbf.		1.25 lbs.
598312075	3/8" Standard Pro-Poly	75'	1,900 lbf.		2.0 lbs.
598313050	8mm NFPA	50'	4,300 lbf.	Throwline	1.41 lbs.
598313075	8mm NFPA	75'	4,300 lbf.	Throwline	1.81 lbs.



RESCUE STICK

Throwable Emergency Rescue Inflatable

The Rescue Stick™ provides rapid flotation assistance to a person at risk of drowning. Simply remove the baton shaped Rescue Stick™ from its waterproof bag and throw near the person. Once contact is made with the water it inflates in seconds to a large horseshoe shape. Measuring only 14" in length and weighing 15.5 oz., the Rescue Stick™ is the most versatile rescue flotation device available. Easily stowed in a boat, vehicle, backpack or by the pool.

The Rescue Stick™ is an invaluable tool for first responders to provide emergency flotation when no water rescue gear is available. Rescue Stick Kit includes Rescue Stick (4), 50' Water Rescue Throwbag (1), and a waterproof storage case.

Weight, Rescue Stick: 25.6 oz.

2049101	Rescue Stick
2049105	Rescue Stick Rearm Kit
59849107	Rescue Stick Kit



LSP CINCH COLLAR

Easy to use - The victim simply enters the harness with head and arms extended before tension is applied by the rescuer. The victim's weight will release the connector and allow the collar to cinch around him, preventing him from slipping out in the event he becomes unconscious. Durable-The interior of the Cinch is a non-absorbent, closed-cell foam. The outer covering consists of a tough, stain-resistant, washable Cordura which provides protection and comfort to the victim.

21542010

LSP Cinch



EXTREME SAR DRYSUIT

Energlo arms help for low or no light conditions. 400-denier TriTon fabric will hold up to years of abuse. Cordura® exterior material reinforces seat, elbows and knees for rugged protection in high-wear areas. Neoprene padding in the elbows and knees provide extra protection while working in the field. Liquid neoprene coating protects latex wrist and neck gaskets from UV rays. TriTon fabric socks. Internal suspenders. Self-draining thigh pocket and a splash proof arm pocket. Heavy-duty YKK® waterproof men's relief zipper and entry zipper seals out water. Neoprene outer cuffs with adjustable hook-and-loop closures on the neck, wrist and ankles protect the latex gaskets. Reflective material on the wrists and piping. Pull cord waist adjustment allows for a more custom fit.

	Size	Color	Size	Height	Weight
20842252924	S	Red	S	5'2"-5'6"	115 - 140 lbs.
20842252922	S	Hi-Viz	M/L	5'5"- 6'0"	130 - 195 lbs.
20842252934	M/L	Red	XL/XXL	5'5"- 6'4"	185 - 245 lbs.
20842252932	M/L	Hi-Viz	Grizzly	5'11"- 6'4"	260 - 305 lbs.
20842252954	XL	Red			
20842252952	XL	Yellow			
208422529G64	Grizzly	Red			
208422529G62	Grizzly	Hi-Viz			

MUSTANG WATER RESCUE DRYSUIT

The Mustang 576 is the next evolution of Mustang Survival's constant wear "cache" dry suit. This suit is ideal for cache equipment. This suit includes:

- YKK metal entry zipper • Comfort fit relief opening • Closed comfort system AS neck seal • Reinforced wrist and ankle overcuffs with Velcro® closures for adjustability • 1050 Denier ballistic nylon wear protection • Two-point attachment removable suspender system for an improved fit, mobility and comfort • GORE-TEX® waterproof & breathable dry suit fabric • Integrated GORE-TEX® dry socks (size XL+ come with jumbo socks) • Adjustable waist band • SOLAS retro-reflective tape on the arms for increased visibility • Reinforced knee pads and elbow pads help prevent injury • Nylon reinforced seat

	Size
204904576322	S
204904576332	M
204904576342	L
204904576352	XL
204904576362	XXL

FRONT ENTRY DELUXE DRYSUIT

Breathable GORE-TEX® Technology

3-Layer GORE-TEX® IMMERSION® Technology fabric is completely waterproof, breathable, and durable. Tightly woven fabric is tough as nails, yet quiet and comfortable. Complete with Gore-Tex® booties, Relief Zipper, Latex gaskets, neoprene trim, metal tooth waterproof zipper. 500 den Cordura® seat and knee patches. Self-draining pockets. Womens' version features "drop-seat" relief zipper.

Color: Mango/Cobalt.



	Description	Size
2309012X	Men's	S-XL
23090126	Men's	XXL
230903X2	Womens	S-XLS

MEN'S			WOMEN'S		
Size	Height	Weight	Size	Height	Weight
S	5'2"- 5'6"	115 - 140 lbs.	S	5"- 5'4"	100 - 120 lbs.
M	5'6"- 6'0"	140 - 175 lbs.	M	5'4"- 5'8"	130 - 150 lbs.
L	5'10"- 6'2"	175 - 200 lbs.	L	5'6"-6'	160 - 180 lbs.
XL	6'0"- 6'4"	200 - 240 lbs.	XL-S	5'4"-5'8"	180 - 200 lbs.
XXL	6'4"- 6'6"	220 - 260 lbs.			



ANKLE WEIGHT SET

For Use with Drysuits

Fully adjustable length with quick-release buckle for safety. Neoprene. Sold in pairs.

Color: Black Weight: 4 lbs. (2 lbs. each)

46001521

Ankle Weight Set



ICE COMMANDER

The suit of choice for Coast Guard, SAR, Fire, and all Ice Rescue Professionals. Its Integral chest harness, ice awl pockets, gloves, reinforcements and non-slip soles keep you prepared for any emergency. Highly visible welded nylon shell and removable AirSoft® foam liner. It's 45% lighter than conventional neoprene suits, giving maximum flexibility and performance.

Size: Adult Universal Body Mass: 110 - 330 lbs. Height: 4'11" - 6'7" Color: Yellow

20499000	Ice Commander
20492001	Replacement Bag
2049228202	Replacement Liner
20492290	Repair Kit



COLD WATER IMMERSION SUIT

Designed for use in commercial operations, the new Immersion Suit from Mustang Survival is the ideal ship abandonment suit for workboats, transport vessels, drilling rigs, supply ships, steamships and commercial fishermen. Also suitable for the sailing community. Color-Coded storage bags indicate sizing.

- Easy to don in stormy conditions
- Five-fingered insulated gloves
- Inflatable head pillow give optimal float angle
- Water-tight face seal
- Wrist and ankle adjustments for a better fit
- 5mm fire retardant neoprene
- Triple-sealed seam construction
- SOLAS grade reflective tape
- SOLAS grade hailing whistle
- Light Pocket fits a variety of SOLAS lights
- Non Slip, durable soles on foot bottom
- USCG approval PENDING; SOLAS compliant
- Includes use and inspection manual
- Includes tube of zipper lubricant

	Size	Bag Color
204923030	Universal Size	Orange
204923024	Adult Small	Red
204923055	Adult Oversize	Green
204923012	Child	Yellow



EXPEDITION UNION SUIT

The Expedition Union Suit delivers ultimate insulation for those cold-water, chilly-air days. Polartec® Power Stretch Pro® fleece provides outstanding warmth, wicking and comfort. 4-way stretch fabric and paddling-specific cut lines allow for a snug and pleasant fit without sacrificing mobility. Form-fitting design allows layering without the added bulk of other mid-weight thermals. "Touch points" on the fabric inner surface draw off the sweat. Then it's quickly wicked to the outer surface where it spreads and evaporates rapidly, to keep you warm and comfortable. Double-stitched seams will withstand years of use and abuse. Double-pull zipper for easy entry and convenient relief.

	Size
2084101322	S
2084101323	M
2084101324	L
2084101325	XL
2084101326	XXL



DRYSUIT UNDERGARMENTS

The next generation of next-to-the-skin layering garments. Made from anti-microbial fabric for warmth, comfort and breathability. These high performance pieces are designed to provide a comfortable, wicking first layer under clothing, drysuits, and wetsuits. Mid-weight made from Polyester and Lycra. Heavy-Weight is 100% polyester fleece.

		Size
20842550x	Mid-Weight Pants	S, M, L, XL
208425506	Mid-Weight Pants	XXL
20842551x	Mid-Weight Shirt	S, M, L, XL
208425516	Mid-Weight Shirt	XXL
228256338x	Heavy-Weight Pants	S, M, L, XL
228256337x	Heavy-Weight Shirt	S, M, L, XL

WETSUIT SIZING

Size	Height	Weight
Men's		
Small	5'2" - 5'6"	115-140 lbs.
Medium	5'5" - 5'8"	135-165 lbs.
Large	5'7" - 6'0"	150-195 lbs.
XLarge	5'10" - 6'2"	185-225 lbs.
XXLarge	6'1" - 6'4"	215-245 lbs.
XXXLarge	6'3" - 6'5"	230-255 lbs.
XXXXLarge	6'4" - 6'6"	245+
Women's		
XSmall	4'8" - 5'2"	90-115 lbs.
Small	5'1" - 5'6"	110-135 lbs.
Medium	5'5" - 5'8"	130-155 lbs.
Large	5'7" - 5'10"	150-180 lbs.
XLarge	5'9" - 6'0"	175-210 lbs.
XXLarge	5'11" - 6'2"	200-220 lbs.
Grizzly		
G-Med	5'5" - 5'9"	200-235 lbs.
G-Large	5'8" - 6'0"	230-265 lbs.
G-XXL	5'11" - 6'4"	260-305 lbs.
G-XXXXL	6'3" - 6'6"	275-320 lbs.

STANDARD RESCUE WETSUIT

Front Zipper



A full-coverage suit. 3 mm Dupont® neoprene provides insulation, while PowerSpan™ panels on the shoulders, back and arms increase mobility. Zippers on wrists and ankles

for easy exit from the suit after a long day. Textured raw neoprene friction zones on the sides help lock a PFD in place. 5 mm seat for extra padding is covered with ToughTex™ for durability. Molded polyurethane knees and shins for long wear and extra protection.

Reflective Lettering and Bright Yellow Panels Color: Yellow/Black. Grizzly Version provides extra room in the chest and waist area.

Standard	Size
208422132	Small
208422133	Medium
208422134	Large
208422135	XLarge
208422136	XXLarge
208422137	XXXLarge
Grizzly	Size
20842213G4	Large
20842213G6	XXLarge



FARMER JOHN / FARMER JANE

Just the essentials, at a great price. The same proven design as the 2.5mm Farmer John, but crafted with thicker 3.0mm neoprene.

• 3.0mm neoprene forms the base and is protectively backed with comfortable nylon on both sides. • Large arm holes assure you full freedom of movement. • Extra-long, double-pull YKK® front zipper for easy entry and relief. • Armored seat and knees have reinforced padding for extra durability and protection. • Zipped ankles make it easy to get over booties.

Farmer John	Size	Farmer Jane	Size
208422243	M	208422251	XS
208422244	L	208422252	S
208422245	XL	208422253	M
208422246	XXL	208422254	L
208422247	XXXL	208422255	XL
		208422256	XXL



GRIZZLY FARMER BILL

Big folks know finding the right size in water gear can be a bear. The Grizzly wetsuit is extra roomy.

• Features 3-mm Neoprene for superior insulation. • Cut large around the chest, waist, thighs and calves. • Combines the convenience of a full-length front zipper with roomy, over-the-shoulder Farmer Bill-style suspenders. • Color: All sizes are black - shoulders are color coded by size.

	Size
20842219G3	Medium
20842213G4	Large
20842213G6	XXLarge
20842219G8	XXXXLarge



2MM WETSUIT JACKET

Combine the 2mm neoprene Wetsuit Jacket with any of our other wetsuits for maximum warmth in your arms and torso. The Grizzly Wetsuit Jacket gives the greater girth needed by the barrel-chested boater. Pair these items with matching Farmer John suits for the ultimate warmth and comfort. 2mm neoprene with Titanium laminate adhesive increases warmth without adding excess bulk. PowerSpan™ under the arms gives you plenty of mobility. The extended waist and raised collar give you superior coverage and increased warmth and comfort. YKK® wrist and full-front zippers provide easy, trouble-free entry.

	Size	Grizzly	Size
208422103	M	20842210G3	M
208422104	L	20842210G4	L
208422105	XL	20842210G6	XXL
208422106	XXL	20842210G8	XXXXL



2MM SHORTY WETSUIT

The Little John and Little Jane Shorty Wetsuits give you a great combination of warmth and comfort. The cut allows more freedom of movement, while 2mm Terraprene™ neoprene provides essential core insulation without unnecessary bulk. Generous armholes give you excellent range of motion. Durable flat-lock seams lie flat on your skin for greater comfort.

• 2mm neoprene retains core body heat and offers cushioning. • Short-cut legs give increased freedom without sacrificing core warmth. • Featuring a full-length, double-pull front zipper for ease of entry and relief.

Men's	Size	Women's	Size	Grizzly	Size
208422173	M	208422161	XS	20842217G3	M
208422174	L	208422162	S	20842217G4	L
208422175	XL	208422163	M	20842217G6	XXL
208422176	XXL	208422164	L	20842217G8	XXXXL
208422177	XXXL	208422165	XL		



LIGHTWEIGHT WATER RESCUE GLOVE

Lightweight, durable glove for all rescuers. 2mm Neoprene on back for lightweight comfort & protection. Palm and fingers of reinforced Amara for durability. Stretch elastic band with Velcro closure.

Size: XS, S, M, L, XL, XXL

23703341x Lightweight Water Glove



UTILITY GLOVE

The Utility Gloves deliver an excellent combination of durability, warmth and dexterity. It's a great choice for rescue work and for the boater who wants maximum palm protection. 2 mm Terraprene neoprene provides excellent warmth for cool to cold conditions. Amara® synthetic leather armor patches on the palm and fingers provide unmatched protection and grip for paddling, rowing and rope handling. A fitted, stretchy slip-on wrist cuff makes the glove easy to put on and take off. Pairing snaps on the wrists help keep the gloves together.

Size: XS, S, M, L, XL, XXL

2084250252	S
2084250253	M
2084250254	L
2084250255	XL
2084250256	XXL



TACTICAL GLOVE

With the perfect combination of durability, warmth and paddle feel, the Tactical Glove lives up to the demands of the task at hand, whether for rescue work or play. 2 mm Terraprene™ neoprene provides warmth and cushioning. Textured armor patches on the palm and fingers provide unmatched protection and grip for paddling, rowing and rope handling. For extra grip and durability, we've added sticky GripCote™ between the armored patches. Soft brushed fleece on the thumb and wrist is handy for wiping your nose or brow. The unique elastic wrist strap secures anywhere on the fleece wrist panel.

208424392	S
208424393	M
208424394	L
208424395	XL
208424396	XXL



HYDROSKIN WETSOCK

Protect your feet and keep them warm without the bulk of other wetsocks. The HydroSkin® Socks are the ultimate wetshoe liner. The 0.5 mm neoprene core insulates and protects. 4-way-stretch Power-Span™ outer layer gives you enhanced mobility and greater durability. The ThermalPlush™ inner lining increases insulation, repels moisture and dries quickly. Titanium laminate adhesive aids body heat retention without adding bulk. DWR coating forces water to "bead" and roll off the material, reduces evaporative cooling.

Size: XS - XXL

208430011x Hydroskin Wet Sock



SEALSKINZ MID-WEIGHT MID-LENGTH SOCK

The SealSkinz Mid-Weight, Mid-Length Sock is perfect for a multitude of activities and weather conditions. It's waterproof and breathable for excellent wearing comfort. SealSkinz patented StretchDry technology creates a hydrophilic membrane that unlike anything else on the market also incorporates a huge amount of stretch. The membrane blocks liquid water while allowing sweat to pass through, keeping your skin comfortable and dry. Totally waterproof, breathable, and windproof. Merino wool lines the interior of the sock for extra warmth and moisture control. The elasticated ankle and insteps offer extra support and a comfortable fit. Y-gore heel construction provides a secure comfortable fit and the padded heel, toe and footbed absorb shock and guard against pressure and friction, reducing the risk of blistering.

Size: XS-XL

208423502	S
208423503	M
208423504	L
208423505	XL



COLD WATER DIVE HOOD

Cold water diving hood with bib. One of the most comfortable and best fitting hoods on the market. 7mm neoprene, 4mm skin-in face seal & 3mm Nylon II bib. Vent at top of hood releases excess air. Face area left unbound for custom trimming.

Size: (SM, M, L, XL, XXL)

23700116x 7mm Hood

COOL WATER DIVE HOOD

1.5mm nylon II neoprene. Face area left unbound for custom trimming.

Size: (SM, M, L, XL, XXL)

23709221x 1.5mm Hood



Standard Kit



Offshore Kit

REACH AND RESCUE POLE KITS

Specialized kits that include pre-selected poles and accessories to fit user needs.

Standard Kit includes:

Pole, Clamping Float, Crook, Body Hook, Pro Snare, Flotation Collar, Pole Bag, Kit Bag, Grappler, Carrago- Scaffold

Offshore Kit Includes:

Pole, Clamping Float, Body Hook, Boat Hook, Line Hook, Flotation Collar, Pole Bag, Kit Bag, Rescue Net, Carrago-Scaffold



	Size	
2017183205	Standard Kit	5 Meter, Carbon Fiber Pole
2017183209	Standard Kit	9 Meter, Carbon Fiber Pole
2017183213	Standard Kit	13 Meter, Carbon Fiber Pole
2017183217	Standard Kit	17 Meter, Carbon Fiber Pole
	Size	
2017184205	Offshore Kit	5 Meter, Carbon Fiber Pole
2017184209	Offshore Kit	9 Meter, Carbon Fiber Pole
2017184213	Offshore Kit	13 Meter, Carbon Fiber Pole
2017184217	Offshore Kit	17 Meter, Carbon Fiber Pole



REACH AND RESCUE ULTRALITE RESCUE POLE

To accurately deploy flotation devices or other tools. The telescopic poles have adjustable clamps. Each clamp releases the section above in a smooth action enabling fast extraction / retraction.

201718205	5 meter
201718209	9 meter
201718213	13 meter
201718217	17 meter



REACH AND RESCUE WADING POLE

The Wading Pole is used as a depth and stability aid when wading through unknown terrain and deep waters.

Material: Fiberglass Color: Yellow w/ Black Handle Length: 5.9' (1.8M) Weight: 2.4 lbs. (1.1 kg)
Pole Diameter: 1.25" (3.2 cm)

2017185151	Wading Pole
------------	-------------





REACH AND RESCUE FLOTATION COLLAR

This is a buoyancy aid that is designed to capture and automatically tighten around a victim in the water. It can also be used to lift a human or animal up to a height while providing a cushioned hold.

2017185102

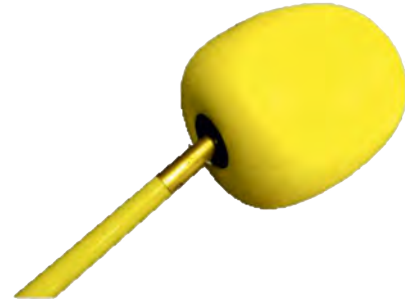

REACH AND RESCUE CLAMPING FLOAT

The clamping Float is the main flotation device for use with the Reach and Rescue Pole system. The main function of the clamping float is to support the pole on the surface of the water. Can act as an individual body buoyancy aid.

2017185101



REACH AND RESCUE RESCUE NET

Used for the safe rescue of small animals. Sturdy but very light weight construction. The soft mesh is knotless and ideal for catch and release purposes. The sleeve fitting should be regularly tested on the pole top fitting as damage will render the attachment from securely fitting.

2017185142



ROPE BLADE

The rope blade attachment is used to cut other materials i.e harnesses, strapping, fishing wire and netting. Safe deployment with capability to sever heavy lines at length.

Weight - 0.2kg | Depth - 3cm (mouth opening - 6cm) | Blade length - Standard "Stanley" blade | Material - Aluminum

2017185134



REACH AND RESCUE KIT BAG

For storing attachments for your Reach and Rescue Pole kit and or other rescue tools. Drawstring opening for quick release, easy to store.

2017185146



REACH AND RESCUE THROWBAG

The throw bag is tossed to a person from a stable position into swift water/rapids enabling the swimmer to grab the rope and get pulled to safety.

2017185143



REACH AND RESCUE POLE BAG

Holds and protects Reach and Rescue poles and closes via velcro flaps. Keep clean and grease free. Check the velcro for function.

2017185145-05	5 meter
2017185145-09	9 meter
2017185145-17	13 / 17 meter



REACH AND RESCUE CARRAGO, SCAFF HOOK

The Carrago attaches a fixed line and Scaffold Hook to a distant eyelet allowing heavy retrieval. This is a large lightweight aluminium Scaffold Hook for larger diameter anchor points and to be used with poles over 13m.

2017185131



REACH AND RESCUE STAINLESS STEEL GRAPPLER

The sleeved fitting is designed to slide over the pole top fitting which secures it in place using a double sprung button mechanism. Use by extending the pole to the casualty with or without the clamping float (depending on distance). Once engaged, normal procedure applies.

2017185123

Grappler



COLOR INSPECTION CAMERA

Used for searching underwater and out of the water.

It has a powerful 12 LED light to illuminate murky waters and confined spaces. It utilizes a powerful, rechargeable Lithium Ion Battery and displays via a clear 7" TFT display. Utilizes a Sony 1/3" CCD with a 135 degree wide angle view. Waterproof to IP68 specifications. Monitor resolution: 800 x 480 pixels with MPEG-4 video compression. Can record both video and audio onto a SD Card (32 GB max file size). Standard cable length: 65 ft. (20 meters). Included 14" diameter cable spool stores and rotates inside the storage case.

2017185160

Color Inspection Camera



REACH & RESCUE STAINLESS STEEL CROOK

The sleeved fitting is designed to slide over the pole top fitting which secures it in place using a double sprung button mechanism. Use by extending the pole to the casualty with or without the clamping float (depending on distance). Once engaged, normal procedure applies.

2017185122



REACH & RESCUE BODY HOOK

Attach the Body hook attachment by sliding onto the gold collar of the pole. This will secure into place with the spring buttons. Extend the pole to desired length and hook the body hook around the casualty's waist and retrieve.

2017185121



REACH AND RESCUE BOAT HOOK

Attach the boat hook attachment by sliding it onto the gold collar. This will secure into place with the spring buttons. Extend the pole to desired length and use accordingly.

2017185120



REACH AND RESCUE LINE HOOK

Attach a line to the eyelet of the carabiner. Attach the Line Hook by sliding the Line Hook over the gold collar on the pole. This will secure into place with the spring buttons. Approach - with the claw point and push through the structure - Engaged - the crossbar snaps shut - Installed - by pulling back the pole, the line threads around the structure.

Pole not included.

2017185128

Stainless Steel

2017185129

Carbon Fiber



REACH AND RESCUE PRO SPRING SNARE

This tool attaches to the universal sprung button sleeve. It is a spring loaded design which needs to be reset after each snaring. The target is placed inside the loop and a light tug on the pole will release the snare locking onto the target. This tool is designed to quickly ensnare an inanimate object or when the operator has no co-operation from the target i.e animal control and unconscious human retrieval.

2017185127



CHAOS SIDE CUT WATER RESCUE HELMET

The Chaos Helmet is your custom-fit solution to whitewater safety. The Chaos Helmet shell is sized and utilizes the Dial*Fit system to let you quickly and easily customize the fit to accommodate almost any head size. An adjustable chin strap ensures comfort and security. Plush FIT pads in key contact points provide extra comfort. Eight ventilation/drainage ports let air in and water out. ABS plastic shell is lightweight and durable and features a glued-in EVA foam liner offers excellent impact protection.

Color: Red, Yellow, White, Blue, Black

Certified to CE En 1385 Helmet Standards.

	Size	Fits Head Circum.
2084426052x	Small	21.3" - 21.9"
2084426053x	Medium	21.9" - 22.6"
2084426054x	Large	22.6" - 23.4"
2084426055x	XLarge	23.4" - 24"



CASCADE WATER RESCUE HELMET

Multiple impact polypropylene, patented liner system. Closed cell foam won't absorb moisture. 4 point chin strap. 13 ventilation / drain ports. Stainless Steel hardware.

Weight: 17.6 oz. Colors: Red, Yellow, White, Blue

	Size / Item Description	Dimensions
48042x	Small	21.6" - 22.25"
48043x	Medium	22.5" - 23"
48044x	Large	23.25" - 23.75"
48045x	XLarge	23.75" - 24"
48046x	XXLarge	25" - 26"
480499	Reflect. 'RESCUE' Crescent	
480498	Reflect. 'WATER RESCUE' Crescent	



HAVOC WATER RESCUE HELMET

Universal Fit

The Havoc Helmet is your one-size-fits-most solution to whitewater safety. The ratchet-adjust DialFit system lets you custom fit the Havoc with the simple twist of a knob. Plush FIT pads in key contact points provide extra comfort and are fixed, so they won't get lost. Ten ventilation/drainage ports let air in and water out of the lightweight, durable ABS plastic shell. Glued-in EVA foam liner offers excellent impact protection. Meets CE 1385 standards for whitewater safety.

Fits a range from 53-62cm (20.86"-24.4") and has an adjustable chin strap.

	Color
208420421	Black
208420422	Yellow
208420424	Red
208420426	Blue
208420429	White



CHAOS FULL CUT WATER RESCUE HELMET

The Chaos Helmet Full Cut Water Rescue Helmet features a shell designed to provide side protection for ears. As with the Side Cut version, it is sized and utilizes the Dial*Fit system to let you quickly and easily customize the fit to accommodate almost any head size. An adjustable chin strap ensures comfort and security. Plush FIT pads in key contact points provide extra comfort. Eight ventilation/drainage ports let air in and water out. ABS plastic shell is lightweight and durable and features a glued-in EVA foam liner offers excellent impact protection.

Color: Red, Yellow, White, Blue, Black

Certified to CE En 1385 Helmet Standards.

	Size	Fits Head Circum.
2084426062x	Small	21.3" - 21.9"
2084426063x	Medium	21.9" - 22.6"
2084426064x	Large	22.6" - 23.4"
2084426065x	XLarge	23.4" - 24"



SEAL XP2 SWIM MASK

This is the mask that revolutionized the water industry by adding fit, functionality, and comfort to aquatic eyewear. Patented curved lens provides 180-degree peripheral vision without distortion. Dive quality silicone skirt provides a comfortable watertight fit. 100% UVA and UVB protection.

46010221	Clear Lens
46010223	Smoke Lens



MAUI DIVE MASK

Low volume, single window design. Black Silicone Skirt. Popular Mask for military and professional divers.

2370503350	Maui Dive Mask
------------	----------------

IMPULSE 3 FLEX SNORKEL

Improved and streamlined. Patented Impulse Dry™ valve stops water from entering the snorkel. Large bore contoured barrel for unrestricted breathing. Self-draining purge valve for use when switching from scuba to snorkel. Pure soft silicone patented Comfo-Bite™ mouthpiece. Includes snorkel keeper.

4601053	Impulse 3 Snorkel
---------	-------------------

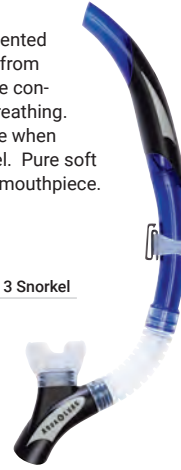

MILITARY FLEX SNORKEL

Classic neoprene rubber design with flex tube. Used by military units worldwide for its versatility and performance. Ideal for rescue and recover dive teams. Includes keeper for mask strap.

23706930	Military Flex Snorkel
----------	-----------------------



HELMET LINER

Much of your body heat escapes through the top of your head. Protect yourself with the NRS Mystery Side Cut Helmet Liner. Under your helmet this liner will keep you warm and comfortable. 1mm of neoprene provides the core insulation for this helmet liner. The GlideSkin™ exterior reduces evaporative cooling, increasing heat retention. Titanium laminate adhesive reflects and retains body heat for superior warmth. Lined with soft ThermalPlush™ fabric for all-day comfort.

		Size
208420263	Full Cut	SM/MD
208420264	Full Cut	L/XL
208420273	Side Cut	SM/MED
208420274	Side Cut	L/XL



ROCKA DRY SUIT SAFETY BOOT

The ROCKA has been developed as a specialist safety water rescue boot designed for use with drysuits and prolonged periods being submerged in water. The boot has a generous internal fitting which is ideally suited for use with bulky drysocks, but still provides excellent comfort, protection and traction even when underwater. It comes with a range of features including the Boa® Quick Release Closure, Kevlar stitched seams, protective toe cap, Vibram Dual Density sole, and reflective inserts. The BOA system ensures that the boot is tightened equally across the foot without being over tight. The low profile dial mechanism is easy to operate and also provides a quick release function, should the boot be required to be removed quickly and easily. The upper design has a bellows tongue, which make the boot easy to don and remove, even when using with a drysuit sock. The boot has a PU protective bump cap and the upper is a mixture of synthetic materials which are suited for use in water, providing excellent durability. The boot is also fitted with a Kevlar® midsole which provides puncture protection against a range of potential hazards. Certified EN ISO 20345:2011

Sizes: 6 - 14

205442040-xx



RESCUE WETSHOE II

Simple, sturdy, dependable. 5mm comfort insole and 2mm plastic midsole. Zippered entry. Manufactured from 3mm neoprene. Sole is wrapped with heavy duty traction pad. Toe and heel cup offer extra protection.

Sizes: 4 - 15 (whole sizes only, 1/2 sizes order next larger size)

Weight: 36 oz. (pair) Color: Black

20842310-xx

Rescue Wetshoe II



ATB DIVE / RESCUE BOOT

All Terrain Bootie combines the comfort of a sneaker with the warmth of a wetshoe. Full molded, arched sole is reinforced with a 2mm plastic midsole shim to increase stability and comfort. 7mm neoprene cushion insoles and 5mm uppers with glued and blind-stitched seams. Heel and toe caps protect from abrasion. Zippered opening.

Sizes: 6 - 14 (whole sizes only, 1/2 sizes order next larger size)

Weight: 47.2 oz. (pair) Color: Black/Gray

20842335-xx

ATB Dive / Rescue Boot



SWIFTWATER WORKBOOT

Used by river professionals, rescue agencies and Navy SEALs, the Swiftwater Workboot / Wetshoe is the hardest-working river boot on the market today. Lace-up synthetic leather and 5-mm neoprene upper provides warmth, unmatched ankle support and a secure fit. 7-mm neoprene insole absorbs the shock of every step. Heavy-duty lugged traction sole keeps you on your feet in varied terrain. Wear areas are reinforced with synthetic leather and rubber. When you need a water shoe that works as hard as you do, on and off the water, the Swiftwater Workboot is your best choice.

Sizes: 6-15 (whole sizes only, Women order one size smaller, 1/2 sizes order next size larger.) Weight: 3.1 lbs.

20842338-xx

Swiftwater Workboot



ROCKET FIN

Quick-Release Strap

One of the first vented rubber fins available. Traditional all rubber design. Popular with military and professional divers.

Dimensions: 18.5 x 8.5" Weight: 6.15 lbs / pair

2370621110

Rocket Fin



SHREDDER RESCUE FINs

Fits over Swiftwater Rescue Boots

Ultra-Light technopolymer optimizes power with up to 50% less weight and bulk. Blade design improves thrust and reduces ankle and leg fatigue. Adjustable buckle with quick-release system secures fins even in swiftwater. Designed to fit all large dive / rescue style boots.

Dimensions: 17" x 9.5" Weight: 4.3 lbs / pair

46005341

Color

46005342

Black

46005349

Yellow/Black

Replacement Strap



UNIVERSAL RESCUE FINs

Designed to meet the demands of swiftwater rescue professionals, the Universal Swim Fins also work well for riverboarding and general river snorkeling. These rigid fins are symmetrical so they fit either foot. The wide heel strap is adjustable with a quick tug of the strap end, then you can unclip the strap and your adjustment stays put. The toe piece has a removable rigid insert that lets you select the stiffness you desire. The fins will fit over your river boots - just step in, click in the heel strap and you're ready to go!

Dimensions: 19.75 x 8.5" Weight: 3.3 lbs. / pair

20841897

Universal Rescue Fins

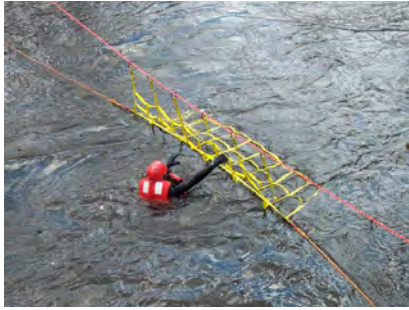

SWIFTWATER RESCUE CURTAIN

The Swiftwater Rescue Curtain provides a versatile tension diagonal grab method to use in moving water. The Curtain rests on top of the water and provides a large grab area for confused swimmers and troubled victims. The 10 ft. wide by 4 ft. tall area enables rescuers to position the Rescue Curtain within the width of a channel to catch a victim who is unable to help himself. When used with a tension diagonal, the Curtain works with the current to hold the swimmer as he or she is pulled to shore. This method reduces the amount of strength the swimmer needs to use to hold onto a device while being pulled out of the current to safety. Attaches to rescue rope with carabiners (not included).

Moving water situations for the Swiftwater Rescue Curtain:

- Tension Diagonals • Pulling victims onto a boat • Hang from a bridge (downstream) • Float in a low head dam and pull to shore

	Length
2414211	10 ft.
2414213	18 ft.



AIRTRACK INFLATABLE RESCUE PATH

The Airtrack is an inflatable rescue walkway for rescues on water, mud, ice and unstable terrain. Constructed in a catamaran type shape, the Airtrack rescue path has two pontoons running lengthways down the underside of the path. This shape provides exceptional stability on water, especially during casualty recovery, and provides extra ground clearance on ice, mud flats and unstable terrain. The unique footprint also prevents suction on to mud and soft surfaces. Several inflatable paths can be connected using the rapid extension link-up feature. Airtracks can either be connected lengthways to extend the path, or sideways to create a rescue raft. The Airtrack inflatable rescue path is compact and portable, packing away neatly into a carrying bag. It can be quickly inflated and deployed allowing water rescue personnel to have access to the casualty within minutes.

- Non-slip top surface • Strong and durable • Stable • Versatile
- Low maintenance

		Weight
2458231002	2 M, Standard	26.5 lbs.
2458231005	5 M, Standard	59.4 lbs.
2458231010	10 M, Standard	121 lbs.



FIBRE-LITE RESCUE CRADLE

For Overboard Recovery, Boarding Ladder and Emergency Stretcher

The Fibrelight Cradle is an innovative new system designed for the recovery of casualties in the water. The Cradle is secured to the craft at the inboard end, with floats attached to the outboard end. The casualty is guided onto the cradle and the outboard end is then hauled in, bring them safely on board in the medically preferred horizontal position. Manufactured from a grid of polyurethane coated polyester webbing reinforced with carbon fibre rods, the Fibrelight Recovery Cradle is exceptionally durable.

Dimensions: 52"W x 120"L

2458231501	2 M
2458231503	3 M

13' SELF-BAILING DELUXE RAFT SET

A deluxe set of Raft Equipment that includes what an existing water rescue team needs for boat operations. Large, wide raft for excellent stability. Self-Bailing Function keeps water from filling up and capsizing the raft. Raft constructed of High grade PVC coated fabric.



29981012

13' Self-Bailing Deluxe Raft Set

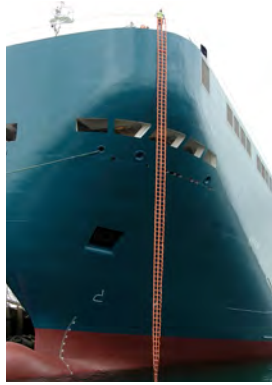

FIBRELIGHT ESCAPE LADDER KIT

The Fibrelight Emergency Ladder is a strong, durable device in use around the world on merchant ships, navy warships, super yachts, and on land in overhead cranes. Deployed by an individual during an emergency in less than a minute. Carbon Fiber inserts in the rungs provide superior rigidity. Rungs meet the ISO 799 strength test (900 kg). Integral standoffs keep the rungs away from the side of the ship making it easier to climb. SOLAS approved. Multiple attachment methods (not included).

2458232702	2 Meter (6.5 ft.)
2458232703	3 Meter (10 ft.)
2458232705	5 Meter (16.4 ft.)
2458232710	10 Meter (33 ft.)
2458232715	15 Meter (49 ft.)
2458232720	20 Meter (66 ft.)
2458232725	25 Meter (82 ft.)
2458232730	30 Meter (99 ft.)



WARNING

Technical rescue and safety is potentially hazardous. Any person using equipment sold by RESCUE TECHNOLOGY in any manner is personally responsible for learning the proper techniques involved, and assumes all risks and accepts full and complete responsibility for any and all damages or injury of any kind, including death, which may result from the use of any RESCUE TECHNOLOGY equipment



RESCUE CRAFT - MOTOR-READY

The RC4000 Rescue Craft from MFC Survival is designed to exceed the performance of a conventional Inflatable Rescue Boat (IRB), while providing the shallow draft and ease of transportation of a rescue sled. The inflatable four meter design incorporates twin keels with a rigid inflatable floor and represents the latest thinking in water rescue boat design. Used with a 25-30hp short shaft outboard motor, the Rescue Craft is capable of making headway in strong currents while the twin keels ensure excellent handling. The RC4000 can be towed or line controlled with or without the motor fitted and is light enough to be carried to where it is needed. When deflated the Rescue Craft packs into a carry bag small enough to fit it together with the motor in the back of a small van or a conventional family hatchback with the rear seats dropped. The RC4000 can carry up to 10 people, or a rescue crew of four, with plenty of room for equipment.

Length: 13 ft (400 cm) Width: 6.6 ft. (200 cm) Height: 2.6 ft (80 cm) Tube Diameter: 19 in. (48 cm) Capacity: 1760 lbs (800 kg) Pack Size: 55" x 20" x 14" (140cm L x 50 cm W x 35 cm H) Max Engine, Short Shaft: 30 hp Weight: 116.6 lbs (53 kg)

245824000	RC4000 Rescue Craft
-----------	---------------------



INFLATABLE RESCUE SLEDS

The RS Series Rescue Sled is great tool for crisis rescues. Fully inflatable, it is lightweight and portable, both inflated and deflated. It is easy to be paddled, pulled by hand, or towed by a jet ski, boat or small hovercraft. The flat bottom makes it exceptionally stable and suitable for use in very shallow water (from only 2"), making it perfect for help in flood rescue. The open, low stern assists with diver deployment and casualty recovery. 10 and 15 man sizes also available. The 3 and 5 man sleds include a removable bolster and are ideal for swift water rescue. The 10 and 15 man sleds have a large floor space and capacity, making them the perfect choice for emergency evacuation and flood rescue situations. To increase capacity, sleds can be linked together.

• Exceptionally tough and durable • Rapid inflation and deployment • Easily launched into the surf zone for sea rescue • Open stern for easy access and self-bailing • Minimal training, servicing and maintenance costs

*Exceeds working floor length of competing open end raft.

		Length
2458230103	RS3 Rescue Sled	8.5 ft.
2458230105	RS5 Rescue Sled	11 ft.
2458230110	RS10 Rescue Sled	13.3 ft.



ENDURANCE RESCUE SLED

The Swiftwater Rescue Curtain provides a versatile tension diagonal grab method to use in moving water. The Curtain rests on top of the water and provides a large grab area for confused swimmers and troubled victims. The 10 ft. wide by 4 ft. tall area enables rescuers to position the Rescue Curtain within the width of a channel to catch a victim who is unable to help himself. When used with a tension diagonal, the Curtain works with the current to hold the swimmer as he or she is pulled to shore. This method reduces the amount of strength the swimmer needs to use to hold onto a device while being pulled out of the current to safety. Attaches to rescue rope with carabiners (not included).

- Tough Hypalon® fabric construction • 3 point inflation • 3 x Pressure relief valves • Reflective SOLAS tape
- 5 x Stainless steel 'D' rings • 10 x rubberised carrying/grab handles • Flip tabs fitted underneath
- Throw bag stowage bungee • 2 x Telescopic paddles • 2 x external lifelines • 4 x boarding/engine mounts • Stowage valise • Double action hand pump

Length: 500cm x Ext Width: 120cm. • Int Width: 75cm Depth: 15cm • Packed size: 80cm x 40cm x 35cm

Weight: 48.5 lbs. (22kg)

2019380424	Red
2019380422	Yellow
2019380429	SCBA Inflation System
20193804245	Detachable Motor Transom



ICE RESCUE SLED

Thin ice is a trap and every year hundreds of people fall into that trap. The RESCUE ALIVE enables your rescuer to run over very thin ice by distributing his weight over a large surface or to paddle through open water to reach a victim quickly. The unit weighs 88 lbs. and provides 600 lbs. of flotation. This unit is deployed by releasing one Velcro strap, which is then used to tether the modified paddle. Pontoons are made from expanded polystyrene core with high density polyethylene covering.

Width: 23" • Length: 89" • Thickness: 6.25"

2414201



LIFESLED™

PWC Towable Rescue Board

Designed for Ocean, Swiftwater and Ice Rescue where a towed board is essential. Severe-duty 3-point non-invasive hookup system with replaceable components. Over 450 lbs. of deadweight buoyancy. Ten fiber reinforced, tacky-when-wet handles are anchored internally. Stows "folded-over" PWC when not in use.

Dimensions: 62" x 36" x 4.52" Weight: 38 lbs.

351511	LifeSled
351503	Rescue Sled Storage Bag



MFC PWC RESCUE BOARD, INFLATABLE

The PWC Rescue Board is an inflatable board that is designed to be attached to the back of a jet ski to aid rapid response and rescue of casualties. It is attached by a towing 'D' ring and two other 'D' rings which are located at the front of the inflatable board. The board has 10 handles fitted around the top sides to make it easier for the casualty or rescue crew to hold onto the board while in use. Double skinned underneath for excellent durability. Fully inflatable the PWC Rescue Board is light-weight and portable and can be quickly inflated when needed. The board deflates quickly and is easy to pack away into the valise provided.

2458230213



CARGO NET WITH STRAPS

Our cargo net is one of the most versatile rafting accessories on the river. It can be secured over the top of your gear to keep it in the boat, or hung between two cross-bars to create a cradle for loose gear. Built with a border of 2" webbing for strength and strap on points for securing miscellaneous gear. Nine 4" HD straps included. Large nets are for boats 16 feet or longer.

	Size	
208418023	S	60" x 80"
208418024	L	70" x 90"



RS-1000 ICE RESCUE SUIT

Rescue professionals need gear that allows them to respond safely and quickly to emergency situations. The RS-1000 Rescue Suit has been engineered to don quickly for cold water and ice rescue operations. This universal fit suit features a rugged hi-tenacity nylon shell that is stitched and taped for the ultimate in durability. A snap out, Internal laminated nylon/foam liner allows the user to easily slip the suit on and off. It has been designed as system to meet the safety, mobility and comfort needs of the rescue professional.

Color: Hi-Vis Yellow Sizes: Universal Fit

21710810002	RS-100 Ice Rescue Suit
21710810009	Armor Palm Glove



DELUXE WATER RESCUE HELMET

Rescue professionals need gear that allows them to respond safely and quickly to emergency situations. The Deluxe WRH is engineered for light weight and comfortable protection. Complies with EN 1385-2012 water helmet standard. Shell manufactured of Hi-Impact ABS with a closed cell EVA molded foam liner. Easy fit ratchet adjuster. Removable foam ear pads. 9 ventilation holes. Accessory side rails and MVG/GoPro mounting bracket.

21710610032	Hi-Viz	Sm/Med	21.0" - 22.5"
21710610034	Red	Sm/Med	21.0" - 22.5"
21710610033	OD Green	Sm/Med	21.0" - 22.5"
21710610042	Hi-Viz	L/XL	22.5" - 24.4"
21710610044	Red	L/XL	22.5" - 24.4"
21710610043	OD Green	L/XL	22.5" - 24.4"



WHITE WATER RESCUE VEST

USCG Type V Vest

The HBV-100 high buoyancy rescue vest has been designed and UL tested to safely carry the gear SAR professionals need to execute their duties. MOLLE webbing is located front and back. The leg harness system distributes load throughout the vest and provides optimum comfort.

FEATURES:

- USCG Approved with up to 22lbs of gear worn on the vest
- 3-D construction (circular) design insures optimum comfort/fit
- MOLLE System for flexibility in attaching accessories
- 3" Shoulder (length) adjustment system
- Leg Harness System
- Quick Release Rescue Belt
- SOLAS Reflective tape Front & Back
- 2-sizes fit up to 56" chest (including body armour worn beneath)

Colors: High Vis Yellow/Black, Red/Black Sizes: S/M/L 34" - 44" L/XL/XXL 46" - 54"

	Size	Color
21710810032	Med/Lge	High Viz
21710810034	Med/Lge	Red
21710810052	XL/XXL	High Viz
21710810054	XL/XXL	Red



RING BUOY

USCG Approved

Unicell soft foam. Won't rot or water log. Diameter: 24". Complete with grab lines.

Weight: 44 oz. Color: Orange

460008	Ring Buoy, 24"
460008-060	Ring Buoy w/ 60 ft. Tether
460008-100	Ring Buoy w/ 100 ft. Tether
460008M	Ring Holder



RESCUE TUBE

Yellow vinyl coating for great visibility and lightweight foam body for handling comfort. 3" x 40" with soft, nylon rope and one-piece body belt. USCG approved bronze snap hook.

Weight: 32.8 oz.

460001	Rescue Tube, 40"
--------	------------------



RESCUE CAN

Features hand grips that are secure and comfortable to grasp and help to calm a panicky swimmer. High visibility Bright Day-glow Orange color.

Dimensions: 27.5 x 8.5 x 6" Weight: 54.4 oz.

460005	Rescue Can
460006	Rescue Can, Max Flotation
460005R	Rescue Can Rack
460006R	Rescue Can Rack, Max Float



INFLATABLE RIVER BOARD

The Inflatable River Board is both compact and extremely versatile for different applications and scenarios. Primarily designed for a rescue swimmer, it is quick to deploy and can be stowed and carried in a backpack for easy deployment. It has single point inflation and can be inflated in seconds by simply using the hand pump provided. It is fitted with 4 grab handles and 3 D-rings with two fitted at the rear and one underneath. The construction is a combination of Hypalon and Drop thread materials which are widely used in the manufacture of rescue boats, sleds and rafts. The Rescue Board is supplied in its own 40L stowage bag with shoulder straps and Super 4 double action hand pump.

Dimensions: 55.5" x 23" x 3" (1.4m x 0.58m (at the widest point) x 0.070mm) · Packed Dimensions: 16"; x 12" x 8" (40cm x 30cm x 20cm) Weight: 7 lbs (3.2kg) · Buoyancy: 200 lbs (90kg);

201938054



CARLSON RESCUE BOARD

Lightweight & Maneuverable

For recreation or rescue. Solid Ethafoam with a slick bottom for performance and durability. (3-year warranty against delamination) Oversize Shipping Charges Apply.

Color: Black Weight: 11 lbs.

20841870

Carlson Rescue Board



PUBLIC SAFETY DIVER QUICK-RELEASE SNAP

A low profile Marine-Grade, Quick-Release snap to be used between Diver's Chest harness and Tender Line. Webbing release strap. Designed to be tied or girth hitched to tender line.

460135 PSD Quick Release Snap



DIVE RESCUE SEARCH LINE

Special 6mm Search Rope reduces resistance and drag as diver works search pattern. Kernmantle design virtually eliminates kinking found in monofilament "tow-line" braid. High quality bag carries 200 ft. of search line.

6mm Rope Strength: 600 lbf. 8mm NFPA Throwline Rope Strength: 3,699 lbf.

		Weight	Length
460022	6mm Search Line	48 oz.	200'
460122	8mm Search Line	68 oz.	200'



PUBLIC SAFETY DIVER CHEST HARNESS

A must for all PSD dive operations. Made with 2" Chest Webbing, 1" Shoulder webbing, and steel D rings. Shown with Diver's Quick-release connector and rope (not included). NOT for high Angle Rescue.

460133 PSD Chest Harness



PRO GUARDIAN WAIST THROWBAG

Strong Dyneema Rope

Features an internal throw rope in a bag that pulls completely free from the waist belt. Includes 55 feet of extra-strong 1/4" Dyneema® rope. Clips securely around your waist with an adjustable belt and a quick release buckle. Webbing loops along the belt are provided for carabiners. Maximum load indicated is for the rope alone.

Rope Length: 55' Rope Size: 1/4" Dyneema® Rope Strength: 2,608 lbs. (max)

208418282 Pro Guardian Throwbag



GUARDIAN WAIST THROWBAG

Lightweight Polypropylene Rope

The Guardian Bag is worn on your waist, so whether you're in your boat or walking the banks, the throw bag is always at your fingertips. Features an internal throw rope in a bag that pulls completely free from the waist belt. Contains 55 feet of 1/4" polypropylene rope. Clips securely around your waist with an adjustable belt with quick release buckle. Webbing loops along the belt are provided for carabiners. Maximum load indicated is for the rope alone.

Rope Length: 55' Rope Size: 1/4" Polypropylene Rope Strength: 950 lbs. (max)

208418281 Guardian Throwbag



PELICAN FLOAT

Marker Recovery System

Reusable Buoy made of structural foamed resin. Includes over 100 ft. polyethylene 225 lbs. test line. Includes 6 oz. non-drag dispatchable anchor.

Color: High-visibility yellow with day-glow rings Weight: 16 oz.

460020 Pelican Float

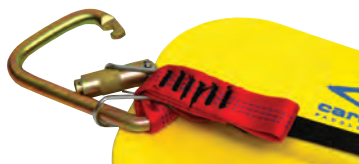

SUPER CLIP - PADDLE

Extends Reach

Superclip Paddle is designed to slip over a paddle blade and hold a carabiner. Now the paddle can be used to extend your reach to a pinned boat or person needing aid. Carabiner and sling not included.

2462003 Super Clip, Paddle



RAFT PADDLE

The industry standard! This 1-1/8" aluminum shaft extends well into the blade for added strength and is covered with polyethylene to provide a warm, secure grip. The 8" x 20" molded blade uses super-strong polypropylene for a powerful yet lightweight paddle.

208415054 60" Paddle



AKUA RESCUE KNIFE

New Water Rescue knife with many features. Quality 420 Stainless Steel, 3" (76mm) Blade Length is the perfect size for a "short knife". Features: Line Cutter, Blunt Tip, Serrated edge, easy quick release sheath with webbing mounts and removable belt clip.

Weight: 6.8 oz.

6301212	Color
6301211	Lime Green
	Black



BLUE TANG DIVE KNIFE

The Blue Tang is a full size, rugged, multifunctional knife designed to meet the basic needs of every diver. Features Power Grip, hooked edge line cutter, 5 inch hollow ground double edge blade. Blunt tip and Steel end cap makes the Blue Tang the perfect work tool for Dive/Rescue.

Dimensions: 10 x 2.2" Weight: 9 oz. Color: Black/Yellow

630125	Blunt Tip
630126	Drop Point



DIVE RESCUE SHEARS

Great for Rescue Diver Safety

EMT Shears in a Pouch that secures to BC Shoulder Strap or autoinflator hose. Includes Stainless Steel 7.5" EMT shears and adjustable pouch.

630111	Dive Rescue Shears
--------	--------------------



SQUEEZE LOCK KNIFE

A classic dive knife. Blade made from 304 stainless steel or high grade Beta Alloy Titanium. Patented Locking mechanism securely locks knife in sheath, but releases easily with a squeeze of the handle. Included mounting components allow the knife to be mounted to grommets, hose straps, or belt. Sheath has molded strap slots for use hose mounting straps.

Length: 6.5" Overall; 3" Blade. Weight: 7.2 oz.

A. 23704752	Stainless Steel Blunt Tip
B. 23704852	Titanium Tanto Tip

PILOT KNIFE

Rescue professionals will really love the features of the Pilot Knife. Features both smooth and serrated sections plus a rope cutting hook. The blunt tip design protects against unintentional punctures! The unique sheath firmly locks the knife in place and only lets it go when you squeeze both sides of the release. Contoured handle and rubberized grip. Clip on sheath attaches firmly to PFD lash tab. Built in glass breaking tip on the end of handle.

Length: 7.5" Overall; 3" Blade.

208427550	Color
208427551	Orange
	Black

FUSILIER RESCUE / DIVE KNIFE

This full feature knife is the perfect knife for rescuer/divers who do not want to carry a big knife. It is small, lightweight and designed to fit every diving style. Features: Power Grip, Serrated Edge, Hooked Edge 4 inch double edge hollow ground blade, One Hand insertion and removal.

Dimensions: 8.75" x 2" Weight: 6 oz. Color: Black/Yellow



630122	Fusilier Rescue / Dive Knife
--------	------------------------------



MECHANICAL PRESSURE GAUGE

This Mechanical Pressure Gauge helps you minimize the risk when inflating your boat and monitoring air pressure. This simple tool can save you a ton of headache and expense. This easy to read, accurate gauge helps you keep your boat inflated to the optimal pressure. Avoid costly blowouts by regularly checking your raft, cataraft, inflatable kayak, SUP board's air pressure to prevent over-inflation. The 0-20 psi capacity covers the widest range of inflatable craft. Gauge tip fits Leaffield and military valves. To use with other valves, such as Halkey-Roberts and Summit, order the optional K-Pump Kwik Check Gauge Adapter Tipcrew in gauge tip adjusts for best valve plunger depression. Gauge tip must be in the valve for reading.

208480007 Mechanical Pressure Gauge
208480084 K-Pump Adaptor



DIGITAL PRESSURE GAUGE

The easy-to read digital display of the NRS Digital Pressure Gauge helps you keep the air pressure in your inflatable raft, cataraft, kayak, SUP or body board exactly where you want it. This accurate gauge can save you a ton of headache and expense. Waterproof casing will make sure that your gauge can handle life on the river. Large, black-on-gray digital display is simple to read and displays pressures from 1.5 to 15 psi. Especially helpful for those with poor eyesight. Gauge tip fits Leaffield and military valves. To use with other valves, such as Halkey-Roberts and Summit, add the optional K-Pump Kwik Check Gauge Adapter Tip. Rubberized housing makes this gauge easy to handle and protects it from impact. Compact, sturdy design works on nearly any inflatable boat valve.

208480008 Digital Pressure Gauge
208480084 K-Pump Adaptor



ICE ANCHOR

Super Corrosion Resistant

Plated CrMo tubes with high strength hangers are the ideal anchor tool for Ice Rescue. Rigging point works like a wrench when screwing the Anchor in or out of the ice.

Length: 7.75" (19 cm) Weight: 7.2 oz.

46001919 Ice Anchor



STABILICERS

Stabilicers™ provide the traction you need to walk, lift, carry or even run on glare ice, reducing injuries in severe winter rescue conditions. Designed with Velcro® fasteners to allow easy attachment over almost any boot or sole. 34 case-hardened, replaceable steel cleats in Vibram® soles bite into ice and snow increasing safety and maneuverability.

Weight: 24 oz. (Med)

	Size/Item Description	Men's Size
208422453	M	8 - 10
208422454	L	10.5 - 12
208422455	XL	12.5 - 14
208422458	Replacement Cleats, 50 ea.	



PICK OF LIFE ICE AWLS

Pick-of-Life awls are for self-rescue, allowing you to crawl on top of the ice using the picks as traction. You can also slide them to someone who has fallen through the ice.

208422459 Pick of Life



WARNING

Technical rescue and safety is potentially hazardous. Any person using equipment sold by RESCUE TECHNOLOGY in any manner is personally responsible for learning the proper techniques involved, and assumes all risks and accepts full and complete responsibility for any and all damages or injury of any kind, including death, which may result from the use of any RESCUE TECHNOLOGY equipment

WATER RESCUE

ACCESORIES & DRYSUIT CARE

Accessories for Water Rescue Personnel. Hangers, Bags, Training Aids and more at RescueTECH.com in our Water Rescue Accessory Section.



WONDER PUMP 6

The Bravo Pump is a great top off pump. This compact pump allows you to connect to even the hard-to-reach valves on any raft. 5' non-kink hose and 7 adaptors are included with the pump. The double action pump, working to inflate on both the upward and downward motions of the handle, speeds inflation. Stroke volume of about 1.6 Gal/6 L.

Dimensions: 4" x 18.5" Weight: 2.25 lbs.

20841701 Wonder Pump 6



BRAVO 2 FOOT PUMP

Inflate small rafts and IK's without back strain. By switching attachment point, the pump works as either an inflator or deflator. Heavy-duty bellows are sandwiched between durable footplates. A convenient 4.5' hose gives you the length you need to reach more than one valve without moving. Includes 9 valve adapters.

Weight: 2.7 lbs.

20841703 Bravo 2 Air Pump



BLAST PUMP

12 vDC

Why pump by hand if you don't have to? Let the Blast Inflator Pump do the work for you. Its compact size and rugged durability will last for years. This 12-volt pump is capable of inflating to 1.5 psi for a fast and easy inflation. It also deflates making it quick and easy to get your inflatable packed back up. Comes with an adapter to fit a wide variety of valve types. Inlaid rubber insulates from heat and sound while providing a more secure grip. 12 foot power cord allows you to easily inflate your boat near your vehicle. Alligator clamps allow quick and easy connection to your vehicle's battery. Pump designed to run for up to 20 minutes without overheating.

20841726 Blast Pump



RAFT REPAIR KIT

Hypalon raft and inflatable kayak repair kit. Contains the essentials for emergency boat material and Leaffield valve repair. Repair parts are fitted in a Witz Utility Locker I Dry Box, with gasket-lined, watertight lid. This kit is intended to give you the basics to make an emergency on-the-water repair. Other items, such as Toluene and Clifton Hypalon Accelerator (sold separately), are recommended for more complete, long lasting repair jobs.

See the parts list for the included items.

- 4 oz Adhesive • One 6"x18" Piece of Tube Material • One 6"x18" Piece of Floor Material • Roller Rasp • Round & Oval Rubber Temporary Patches • Sand Paper • Hypalon glue instructions included • Leaffield Valve Wrench • Leaffield Adapter • Plug for Leaffield PR Valve • C7 Repair Kit: Pin, Spring, Rubber Stopper

208419844 Hypalon (Red)
208419846 Hypalon (Blue)
208419769 PVC (Gray)



RAFT CLEANER

High-quality cleaner formulated specifically for PVC and Hypalon® inflatables. Removes dirt, oil, stains and frame marks. Rinse surface before applying, and apply 303® Protectant after cleaning. Biodegradable.

2084191864 Gallon



RAFT PROTECTANT

The most powerful UV screening protection ever made. Use it on everything from boats to apparel. 303 Aerospace Protectant is - "SPF 40 For Your Stuff!" Helpful in prolonging the lifetime of your raft. Don't forget to use this on your paddling apparel that have latex gaskets. For use on vinyl, clear vinyl, inflatable boats, fiberglass, rubber & all UV sensitive plastics. Easy to use - just spray on and wipe dry! Environmentally safe product that is non-toxic and biodegradable.

2084190916 16 oz. Spray
2084190932 32 oz. Spray
2084190964 Gallon Bottle



SL3 eLED DIVE LIGHT

The SL3 eLED is UK's latest high performance LED dive light designed with a divers tight budget in mind. The exclusive CPO optics guarantees a tight beam with minimum spill light and the Thermal Recovery System recycles wasted heat from the LED back into the battery for increased brightness and burn time. A non-corroding resin case, double o-ring seals, 500 foot depth rating and a rear stainless steel attachment loop as well as 98 lumens output and 30 hours run time all make the SL3 worthy of clear water diving or as an essential technical diving back-up light. Twist ON/OFF bezel sealed with two O-Rings. Beam produces a bright spot with almost no peripheral light, reducing backscatter. Stainless steel pressure relief valve releases excess pressure due to battery malfunction or flooding. Stainless steel loop clips to BC accessory snap clips. Made in USA.

Weight: 11.8 oz. Dimensions: 7.5" x 1.9"



MERIDIAN STROBE

The Meridian LED emergency strobe and locator light is visible for over a mile. The body is designed to be low-profile and adaptable to a wide range of uses: easy attachment to PFD, SCUBA tank or any 1" webbing is possible. The toggle switch allows for operation of red and white strobing modes. Built to withstand the rigors of diving, the light is waterproof to the IPX8 standard. Batteries included.

Power: 100 Lumens; LAMP: 1 White Maxbright LED, 1 Red Maxbright LED; BURN TIME: 100 Hours; BATTERIES: 3 AAA Alkaline; WEIGHT: 5.6 oz (101 Grams)

488307

Meridian Strobe



C-STROBE LED

Slim and lightweight design fits easily in a pocket or hangs discreetly when attached to a life jacket or backpack. The flexible lashing loops on the side of the product allow for multiple mounting options including the webbing on your backpack or straps on your life jacket. Velcro® strap can be secured around the lashing loops and creates countless additional mounting possibilities. The light also comes with a clip designed to conveniently slide over your inflatable life jacket's oral inflation tube for storing your light inside your life jacket. Also available in a water activated model. Included Velcro® strap (with carded version) used in conjunction with integral lashing loops for mounting flexibility; Included PFD clip for easy attachment to oral inflation tube.

Power: 45 Lumen White LED; Burn time >120 hours; Waterproof – tested for 24 hours at 1 meter; 2AA 1.5V batteries (not included) USCG/SOLAS approved.

238019153

C-Strobe LED

238019154

C-Strobe LED, H2O Activated



ACR HEMI LIGHT 3

Smaller than other approved lights, the HemiLight™ features rounded edges to maintain the integrity of inflatable life jackets. Attachment loops accommodate up to 5 cm (2 in) wide webbing, and the marine tough design ensures years of useful service. The high-intensity flashing LED light automatically activates for 20+ hours when it comes in contact with salt or fresh water, and can be deactivated simply by pushing the red button. Installation is quick and easy (the HemiLight™ 3 can be retrofitted to almost any style life jacket in a matter of seconds). Available in two configurations: the HemiLight™3 offers a basic strobe mode which can be activated either manually or automatically.

248837681



CYALUME LIGHT STICK

6" Lightstick give rescuers a great lighting tool. Shelf Life: 5 years. Glow time 8 or 12 hours. Individually wrapped.

24426125

12 hour Green

24426124

12 hour Red

24426120

12 hour Orange

24426122

12 hour Yellow

24426089

8 hour White



ECOFLARE

Interchangeable halogen bulb and red Ultrabright LED make the EcoFlare a flashing beacon or area an area light. Compact and waterproof. A vital part of any outdoor enthusiast's equipment bag, the Eco Flare can be set on constant, high-output, incandescent mode for use as an area/personal locator light, or on flashing, red Ultrabright LED mode for low-visibility, dark nights. The Ultrabright LED will burn in excess of 500+ hours on 2 AAA alkaline batteries. The Eco Flare can also be attached to your dogs collar for easy identification in low light conditions.

Power: 1 watt / 6 Lumens Lamp: High output bulb, 1 Ultrabright red LED Batteries: 2 AAA Alkaline Burn Time: 500 hrs. Weight: 1.48 oz (42g)

488305

EcoFlare



DIVE MASK TRAINING BLACKOUT COVER

Finally, a reusable Diving Mask Cover that works. Made from tough, coated nylon fabric and elastic drawstring adjuster. Can be easily removed in an emergency situation. Excellent access to nose cup for clearing ears.

460101	Standard Mask Blackout Cover
460111	Full Face Mask Blackout Cover



TRAINING AIDS

Rescue Diver training aid requirement. Solid rubber. For pool skills training for divers. 5" Donut rings may be used for assorted training exercises.

4600161	Block, 10 lb. (each)
4600162	Donut, 5" (each)



ZIPPER LUBRICANT

Lubricates and prolongs the life of zippers on wet-suits, drysuits and booties.

20842288	Zip Tech
----------	----------



SEA GOLD ANTI FOG GEL

Rated BEST Anti-Fog by Rodale's SCUBA DIVING Magazine! The clear choice in anti-fog gels. Our unique clear formula means long lasting anti-fog protection. Sea Gold is highly concentrated and designed for quick, simple, in-field application. Sea Gold is safe for all glass and plastic lenses and will not harm surrounding silicone or rubber support frames. Not recommended for swim goggles.

238140851

Sea Gold, 1.25 fl. oz.



ZIPPER CARE

Zip Care is the ultimate zipper care for plastic, nylon or metal zippers. Unique push-pull brush top enables the cleaner to be delivered between the teeth and physically removes harmful dirt, sand, and salt deposits that can jam the zipper. Cleans drysuits and wetsuit zippers. Mild lubricant without silicone.

20842290

Zipper Care



AQUASEAL WETSUIT REPAIR ADHESIVE

The industry standard for maximum strength repairs to wetsuits, dry suits and all water sports products. Flexible urethane formula waterproofs, seals and protects against abrasion. Hundreds of water sports and household uses. Flexible Urethane formula that waterproofs, seals and protects against abrasion. Flammable - UPS ground only.

2282572

Aquaseal, 1 oz. Tube

WETSUIT SHAMPOO

Complete, scientifically balanced maintenance system for all neoprene and water sports gear. Ideal for wetsuits, drysuits, boots and gloves, fishing waders, orthopedic supports, lycra body suits and more. Leaves neoprene articles free of organic residue, chlorine and salt deposits. Chlorine-removing agents and conditioners help prevent premature aging and oxidation.



20842249
208422481

Gallon
10 oz.

303 HIGH TECH FABRIC GUARD

Protects Drysuits and PFD's

Powerful enough to protect fabrics in the harshest environment... outdoors. 303 High Tech Fabric Guard™ helps keep your gear looking and performing like new. Restore lost water repellency and stain repellency without affecting the breathability of the fabric. Use after cleaning fabrics to revive water repellency and stop leaks. Helps to repel dirt, grease, water, oil-based stains and UV rays. Non-toxic and odorless formula is easy - spray on, let dry.

Weight: 16 oz.



2084190816

303 Fabric Guard



SUPER HANGER

Useful and economical for hanging a variety of dive equipment.

Dimensions: 9" x 16.6" x 1.2" Weight: 9.6 oz.

460012 Super Hanger \$8.10



SUPER B.C. HANGER

Keeps Expensive equipment off the floor for proper drying and storage. Supports up to 20 lbs.

Dimensions: 10" x 16" x 1.2" Weight: 8.8 oz.

460010 Super B.C. Hanger \$10.35



SUPER ACCESSORY HANGER

Ideal for drying and storing gloves, booties and hood.

Dimensions: 13" x 20" x 1.2" Weight: 14.4 oz.

460011 Super Accessory Hanger \$16.25



DRYSUIT / EXPOSURE SUIT HANGER

Wide 4.5" hanger "arms" for ultimate protection of expensive Drysuits and Exposure suits.

Dimensions: 15" x 16" x 4.5" Weight: 1.35 lbs.

460013 Drysuit Hanger \$28.50



Lanyard Not Included

FOX WHISTLE

One of the loudest whistles available. "Pea-less" design functions when wet - even under water.

Color: Orange, Yellow

2282465x	Fox 40 Whistle	\$7.00
2282469x	Fox 40 w/ Coil	\$7.80

WATERPROOF RADIO POUCH

Waterproof to 30 ft.

Total watertight protection, effectively and inexpensively, to hand-held VHF/UHF radios. Waterproofs your radio in seconds. Will float with radio inside. No loss of signal. Salt-water proof. UV-Stabilized. Operating temperatures: -25°C to +90° C. Complies with SOLAS.



		Dimensions	
811139	Standard	13" x 3.9" x 6.9"	\$36.00
811149	Large	15.7" x 5" x 7.9"	\$36.00



WARNING

Technical rescue and safety is potentially hazardous. Any person using equipment sold by RESCUE TECHNOLOGY in any manner is personally responsible for learning the proper techniques involved, and assumes all risks and accepts full and complete responsibility for any and all damages or injury of any kind, including death, which may result from the use of any RESCUE TECHNOLOGY equipment.



TRAINING

BOOKS & VIDEOS

We have collected the finest selection of books for Technical Rescuers. All of the books we offer are the most current edition and give rescuers extra resources for training and planning. From Water and Ice Rescue to High Angle, Trench and Confined Space. We have them all!



PUBLIC SAFETY DIVING
By Hendrick and Zafers
 Written for instructors, dive team captains, surface teams, and underwater personnel. Offers information on procedures for safe operations and proper methods of training. Safety is the consistent theme throughout, with an emphasis on surface support, accident prevention, contingency procedures, and standard operating guidelines. Includes methods of search in Black Water, Swiftwater, and Contaminated Water.

899130 Public Safety Diving

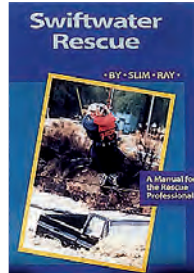

SWIFTWATER RESCUE
by Slim Ray
 An in-depth look at swiftwater rescue for the professional. Topics include basic rescuer safety considerations, river hydrology, equipment, shore-based, boat-based, and in-water rescue techniques, medical considerations, rigging for river rescue, incident command, and swiftwater training. Illustrated with line drawings and photographs.

Paperback 360 pages.

899122 Swiftwater Rescue



SWIFTWATER FIELD GUIDE
Companion to Swiftwater Rescue
 Handy 4" x 6" pocket reference to topics like basic rescuer safety, river hydrology, equipment, shore-base, boat-based, and in-water rescue techniques, knots, rigging for river rescue, helicopters, incident command, and special situations.

52 pages
 899124 Swiftwater Field Guide



SWEPT AWAY DVD
Video Guide to Water Rescue Operations
 A comprehensive rescue training film that has been specifically developed for emergency personnel who are called upon to respond to water emergencies. Swept Away provides an in-depth look at the essentials of water rescue and can serve as an invaluable training resource for both new and experienced emergency personnel.

Running Time: 30 Minutes
 899520 Swept Away DVD



STAYING ALIVE: SWIFTWATER RESCUE TECHNIQUES - DVD
 This video can be used as a training aid or as a great addition to your reference library. It contains the latest in rescue techniques, with many live footage scenes & actual rescues. Perfect for the first responder all the way up to Technical Rescue Professionals. Includes: rescue basics, gear, hydrology, river features, rescue scene management & incident size up, self rescue, and more. Also knots, anchors, lowhead damn rescue, foot entrapment & PFDs.

899521 Staying Alive, DVD



RIVER RESCUE
by Bechdel and Ray
 A must read for the weekend warrior or the hard-core pro and provides useful tools and techniques for self rescue and rescue by others. Through all editions, Bechdel and Ray's River Rescue has remained an invaluable resource for anyone who has gone boating. With even more illustrations and photographs this completely revised new edition will help you prepare for the adventure that lies ahead.

899110 River Rescue

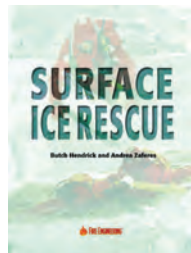

SURFACE ICE RESCUE
By Hendrick and Zafers
 This book provides practical, up-to-date information on training, team management, equipment, and techniques for ice rescue teams.

- Preplanning • Three levels of training • Managing an operation
- Ice rescue equipment • Duties and responses • Communication
- Special situations • The four processes of heat loss

200 pages
 Dimensions: 7"x 10"

899134 Surface Ice Rescue



Z-DRAG CRIB SHEET
 Durable plastic "crib sheet" is a handy reference when you need to rig a quick 3:1 mechanical advantage system. They show how to set up a Z-Drage, Vector Pull, C+Z, Double Z. Also includes important knots.
 Dimensions: 6 x 3.75"

899116 Z-Drage Crib Sheet



WARNING

Technical rescue and safety is potentially hazardous. Any person using equipment sold by RESCUE TECHNOLOGY in any manner is personally responsible for learning the proper techniques involved, and assumes all risks and accepts full and complete responsibility for any and all damages or injury of any kind, including death, which may result from the use of any RESCUE TECHNOLOGY equipment.

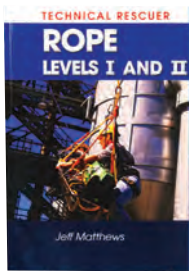

TECHNICAL RESCUER ROPE - LEVELS I & II

Practical, thorough, and current, this guide to rope rescue offers you detailed instructions for numerous rope rescue techniques, as well as industry insight on how to apply these techniques effectively on scene. Based on the 2008 NFPA Standard 1006 and

2009 NFPA Standard 1670 Technical Rescue: Rope Rescue provides expansive coverage, including commonly used knots, practical rigging methods, incident and scene management, lowering systems, tensioned rope systems, and more. With a comprehensive yet simplified approach to a wide variety of techniques, the book breaks down some of the barriers that have traditionally divided urban rope rescue teams and rural or wilderness rescue teams.



TECHNICAL RESCUE FIELD OPERATIONS GUIDE

5th Edition by Tom Pendley

Contains over 150 high quality graphic illustrations, command checklists, and easy to follow, step-by-step procedures for rope rescue, confined space rescue, swift-water rescue, trench rescue, structural collapse rescue, and helicopter rescue.

Dimensions: 4" x 6.5"



TECHNICAL RESCUE RIGGERS GUIDE

Contains dozens of illustrations and photographs to use as a quick reference for modern rope rescue techniques. This handy guide displays pulley systems, tandem prusik belays, knots, bends, hitches, litter packaging, and much more. Note: This is not an instructional text, but rather a quick reference guide for trained personnel.

Dimensions: 4" x 6"

899135

Tech Rescue, Rope I & II

899120

Technical Rescue Ops Guide

899123

Technical Riggers Guide



TECHNICAL RESCUE OPERATIONS VOLUME I Planning, Training & Command

The new rules of rescue have improved the way firefighters and other first responders are able to detect, locate, treat, and extract trapped victims in practically any situation by emphasizing factors

like innovative training, better equipment, and more intelligent planning by well-informed decision-makers. Technical Rescue Operations, Volume I: Planning, Training, and Command lays the framework for responding to technical rescues and disasters of all types in the safest and most effective manner.



TECHNICAL RESCUE OPERATIONS VOLUME II Common Emergencies

The second in a 3-volume series covers responding to, managing, and conducting rescues in the "daily" setting of fire/rescue agencies. This volume explains how to handle more complex and large-scale rescue

operations that challenge responders to apply solid rescue principals for longer periods of time, with the assistance required of additional resources and under more strict command and control because of the scope of the incident, its newsworthiness, crowds of people arriving on the scene, and getting the immediate attention of local or regional elected officials.

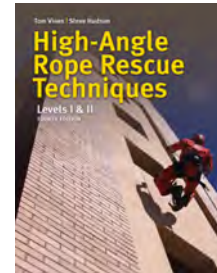

HIGH ANGLE RESCUE TECHNIQUES

4th ed. with Navigator2 Advanced Access

The classic HART book has long been a comprehensive source of all aspects of high-angle rescue, including planning, PPE and equipment, medical considerations,

evacuations, and special rescue operations. Based on the 2013 edition of NFPA 1006. Includes new protective equipment terminology and techniques, new Skill Drills, and separation of Job Performance Requirements of Rope Rescue Levels I & II. Hundreds of Photos and illustrations. Includes handy Field Guide.

Dimensions: 8.5 x 11"

899132

Technical Rescue Ops I

899133

Technical Rescue Ops II

899107

H.A.R.T w/ Field Guide



THE MORROW GUIDE TO KNOTS

A MUST book for those interested in tying or teaching knots. Excellent directions for tying nearly all useful knots. Sections on cordage, utility knots, hitches, tackle, and decorative knots. 259 pages, over 600 photographs.

Dimensions: 7.5 x 5"

899105

Morrow Guide To Knots



ON ROPE - 2ND ED.

Excellent reference for those interested in single rope techniques. Written from a recreational point of view, it is nonetheless comprehensive and very informative. Contains large glossary of rope work terms and describes rappelling, ascending, and other techniques.

Dimensions: 8.5 x 11"

899108

On Rope



WARNING

Technical rescue and safety is potentially hazardous. Any person using equipment sold by RESCUE TECHNOLOGY in any manner is personally responsible for learning the proper techniques involved, and assumes all risks and accepts full and complete responsibility for any and all damages or injury of any kind, including death, which may result from the use of any RESCUE TECHNOLOGY equipment

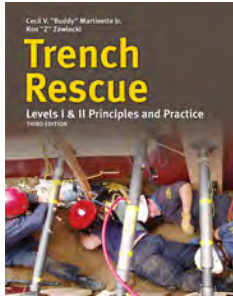

TRENCH RESCUE: LEVELS I & II PRINCIPLES AND PRACTICE

The most comprehensive textbook ever published on rescue operations in trench emergencies. Author C.V. "Buddy" Martinette covers everything from basic concepts of risk benefit

to practical procedures for technician-level trench protective systems. The Second Edition includes current information on trench tools and equipment, PPE, rescue system preparation, types of collapse, hazard control, and more. The text includes up-to-date coverage of Trench Rescue Sections of NFPA 1670, NFPA 1006, and OSHA CFR § 1926 Subpart P, Excavations. The Second Edition now helps students make more effective use of class time by providing printed PowerPoint slides directly within the text.

TRENCH RESCUE

A must read for those in trench rescue situations, this vital new resource demonstrates a systematic approach to safely and successfully carrying out a trench rescue operation. 258 pages. Over 300 step-by-step photos.

Dimensions: 8.5 x 11"



Shown on Cascade Water Rescue Helmet (not included)

899119

Trench Rescue

ESS STRIKETEAM GOGGLES

Designed for Technical Rescue and Wildland Fire Fighting equipped with a thick polycarbonate lens that has been hardcoated and anti-fog treated both inside and out. Soft open cell facefoam designed to fit over most eye glasses. Comes with flame resistant Velcro™ tabbed elastic strap which features instant fit speed clip.

Exceeds ANSI Z-87.1 and CSA Z94.3-92. Weight: 6.4 oz.

481601	StrikeTeam XTO
481609C	Replacement Lens, Clear
481608	Tear Off Lens Covers

899151

Trench Rescue: Level I & II



CONFINED SPACE RESCUE

by Chase Sargent

Bridges the gap between theory and practice. A comprehensive guide to hazardous atmospheres, detection equipment, breathing apparatus, ventilation, retrieval systems, backup teams, and operational procedures. Covers: Forming a Team, Planning, Training, Equipment, Command, Response, Entry & Rescue, and much more.

244 pages

899112

Confined Space Rescue



COMMAND BOARD

The Accountability / Command board helps keep track of rescuers and organizes your incident command structure. It features an 18" x 24" dry erase board with the ICS structure screened on it. Includes velcro strip for name tags and twin flashlight harnesses to light the board. Manufactured from padded Ballistic nylon, pockets accommodate two radios or cell telephones and zippered pockets for clipboards, command vests, and writing utensils. The case will stand by itself or hang from a vehicle window or roof gutters to make a handy command station/table.

Equipment not included.

809801

Command Board



HELMET LIGHT HOLDER

Multi-directional adjustable light holder. Three piece set designed to fit all hard hats and fire helmets without drilling or gluing. Attaches to either left or right side and does not interfere with visors. Fits VersaBrite, VersaBrite II, Mitylite and Stealthlite and Mini Q-4.

4870700	Polycarbonate
4870760	Stainless Steel



Technical rescue and safety is potentially hazardous. Any person using equipment sold by RESCUE TECHNOLOGY in any manner is personally responsible for learning the proper techniques involved, and assumes all risks and accepts full and complete responsibility for any and all damages or injury of any kind, including death, which may result from the use of any RESCUE TECHNOLOGY equipment

PROTECTIVE WEAR

FIELD OPERATIONS GEAR

From Helmets to lighting devices, our equipment protects rescuers during field operations. Durability and quality are paramount factors when choosing protective equipment and we have taken care of this for you. Our selection allows rescuers to get the best fit of equipment to the users' requirements.



R6C RESCUE HELMET

The R6C is suitable for USAR, Paramedics, Rescue/Recovery, and Bush/Wildland Fire Fighting. Features a light weight Kevlar and fiberglass reinforced composite shell that has UV-resistant hi-gloss paint finish. Headband with removable leather or merino for cleaning and replacement. Nape strap with ratchet size adjustment between 20.6"; - 25.4" (52-64cm) for comfortable fit. Nylon webbing cradle system for optimal comfort and 4-point polyester chinstrap comes with quick release buckle.

Certified AS/NZS 1801, NFPA 1951

23628053506	Blue
23628053509	White
23628053504	Red
23628053504B	Red w/ Front Bungy
23628053509B	White w/ Front Bungy



R6 DOMINATOR

Retractable Eye Protector and Dynamic Sealed Ventilation System™

The latest utility rescue helmet, featuring the open-close Pacific DSVS™ Dynamic Sealed Ventilation System. Pacific Ribbon cradle interior. Features: Light weight fiberglass reinforced composite shell with a UV-resistant hi-gloss paint finish. Headband with removable leather for cleaning and replacement. Nylon webbing cradle system and nape strap with ratchet size adjustment. 4-point polyester chinstrap comes with quick release buckle. Internal Eye Protector. ESS goggle mounts and Earmuff mounting clips.

Meets ANSI/ISEA Z89.1-2009 requirements. Certified to EN 12492, AS 1801 Type 1 & 2

23628053036	Red
23628053048	White



R5SL NFPA HELMET

Certified NFPA 1951

The R5SL Series of multi-purpose helmets are ideal for rope rescue, technical rescue, or USAR operations. The lightweight DuPont™ Kevlar® reinforced outer shell offers superior strength and durability and is backed by a 6-year warranty. The best warranty in the industry! The R5SL NFPA Helmet's lightweight DuPont™ Kevlar® and composite shell weighs less than competitive fiberglass and composite alternatives. Composite resins offer higher temperature resistance (up to 600°F) without distorting or melting. 3-point polyester chinstrap with quick-release buckle keeps helmet in place and the 6-point ribbon cradle harness offers superior comfort.

Weight: 20.8 oz.

Compliant to ANSI Z89.1 and certified to NFPA 1951 Utility Standard.

4815532	Yellow
4815534	Red
4815536	Blue
4815539	White



R3V4 USAR W/ FLIP DOWN VISOR

Certified NFPA 1951

The R3V4 USAR helmet is a natural progression of the R3 USAR Helmet. Featuring a Flip-Down visor, the helmet features lightweight DuPont™ Kevlar® and composite shell that weighs less than competitive fiberglass and composite alternatives. High-gloss paint finish available in a variety of colors. Ratchet headband with easy-to-adjust dial ratchet accommodates a variety of head sizes (54-64cm). 3-point Nomex® chinstrap with flip-down visor.

Weight: 36.8 oz.

Certified to EN443 and NFPA USAR 1951-2007. Compliant to ANSI Z89.1 (type 2).

481444	Red
481446	Blue
481449	White



R3-KIWI™ USAR HELMET

Certified NFPA 1951

Lightweight Kevlar brand fiber / composite shell. Temperature resistance up to 600° F without distorting or melting. Polyurethane impact liner with leather sweatband provides impact and thermal protection. Reflective Trim. High-gloss paint finish. Ratchet headband with easy-to-dial adjuster. 3 point nomex chin strap. Certified NFPA 1951.2007, EN443. ANSI X89.1 Type 2 compliant. Custom lettering with clear coat finish available.

Weight: 36.8 oz.

481434	Red
481436	Blue
481432	Yellow
481439	White



R5 KIWI RESCUE HELMET

Lightweight DuPont Kevlar® and composite shell weighs less than competitive fiberglass and composite alternatives. Very Lightweight with a small profile for work in confined spaces. 3 point polyester chin strap with quick-release buckle. New scallop-sided shell designed to accommodate a variety of ear muffs. Ratchet headband with easy-to-adjust dial accommodates head size 21.6" - 25.6". One Size Fits most. Light Pod version works best with UK4AA. Complies to AS 1801 and ANSI Z89.1 Type 1.

Weight: 19.2 oz. (std)

		Color
4815514	R5 Rescue Helmet	Red
4815516	R5 Rescue Helmet	Blue
4815519	R5 Rescue Helmet	White
		Color
4815524	R5 Helmet, Light Pod	Red
4815526	R5 Helmet, Light Pod	Blue
4815529	R5 Helmet, Light Pod	White



R3-KIWI RESCUE HELMET

The ultimate in comfort and protection. DuPont Kevlar® shell and full polyurethane impact headliner. Proven in the field by USAR/FEMA and Task Force One personnel. Adjustable Ratchet Headband with multi-point chin strap. Light pod version works best with UK4AA.

Weight: 32 oz.

ANSI Z89.1 Type 2 compliant.

		Color
4815314	R3 Kiwi	Red
4815316	R3 Kiwi	Blue
4815312	R3 Kiwi	Yellow
4815319	R3 Kiwi	White
		Color
4815324	R3 Kiwi, Light Pod	Red
4815326	R3 Kiwi, Light Pod	Blue
4815322	R3 Kiwi, Light Pod	Yellow
4815329	R3 Kiwi, Light Pod	White



WR5 MULTI-USE

For High Angle and Water Rescue

Shell made with Dupont Kevlar® with 9 ventilation holes. 6 point suspensions with dial ratchet. 3 Point nylon chin strap with quick-release buckle. Ratchet adjustment expands to 25". ANSI Z89.1 compliant.

Weight: 17.6 oz.

481544	WR5 Helmet, Red
481546	WR5 Helmet, Blue
481549	WR5 Helmet, White



A10 USAR EMS HELMET

Progressive Design with Flip-Down Visor

A new lightweight Dupont™ Kevlar® reinforced Jet Style Helmets that offers contemporary style with a high-tech Dupont™ Kevlar® reinforced outer shell. Pacific's Jet styles weigh less than competitive brands and include an internal retractable face shield and a 2 ply Nomex® neck protector as standard features. The Dupont™ Kevlar® reinforced outer shell is backed by a 6-year warranty. The best warranty in the industry!

• Polyurethane impact liner w/ cradle ribbons. • Leather Headband Ratchet style adjuster. • 3 point Nomex Flame retardant chinstrap • Eye Protector 1.5mm w/ nose guard. • Certified to EN443. • Compliant NFPA 1951 USAR

4813119	White
4813116	Blue



REFLECTIVE HELMET LABELS

Reflective Labels that are a great addition to helmets. Reflectivity adds to safety and identification.

482101	"Rescue" Crescent
482104	"Fire Rescue" Crescent
482103	"Instructor" Crescent
482106	"Rescue Chief" Crescent
482107	"Rescue Squad" Crescent
482108	"Haz-Mat" Crescent
482109	"Chief" Crescent
482212	Stripe, 1" x 4", pair (YE)
482222	Trapezoid, Set of 5 (YE)
482111	Star of Life Decal



Shown on R3 Helmet with Light Pod (not included)

XTRICATOR™ GOGGLES

For R3, R4, and R5 Rescue Helmets

The ideal solution for primary eye protection for extrication and forcible entry work. Snaps onto the goggle attachment points of the R3, R4, and R5 Rescue Helmets. The ESS X-tricator™ can be stored in a pocket and deployed using the Snap-On/Snap-Off™ helmet mount system, providing the performance of an ESS goggle in seconds. Includes a set of two Tear-Off Lens Covers.

Weight: 4.8 oz.

481539G

Xtricator Goggles



VIZIR™ AND VIZEN™

Protective Shield for VERTEX and ALVEO helmets

The VIZIR and VIZEN visor ensures eye protection and integrates perfectly into VERTEX and ALVEO helmets. It is installed easily with its inserts.

• Easy to mount on VERTEX and ALVEO helmets with purpose-built inserts • Scratch- and fog-resistant

23540115

VIZIR Eye Shield, Clear

235401151

VIZIR Eye Shield, Smoke

235401140

VIZEN Full Face Shield, Clear



VERTEX™ BEST

Helmet for work at height and industry

The adjustment wheel has two height positions and the chin strap can be adjusted for a perfect fit. Side slots and the above-the-ears cut of the shell allow attachment of standard hearing and eye protection. Four clips, on the outside of the helmet, correctly hold a headlamp. Polycarbonate shell, resistant to impact and wear.

Weight: 492 gms

Meets CE and ANSI Z89.1 - 2003 -Type I class E.22.4

2354011010

Color

2354011011

Orange

2354011012

Black

2354011014

Yellow

2354011016

Red

2354011019

Blue

2354011019

White



ALVEO BEST™

Lightweight helmet for work at height and rescue

A lightweight helmet for workers at height. Its un-ventilated shell ensures protection against electrical risks and molten metal splash. CenterFit adjustment system adjusts the headband and keeps it centered on the head.

Weight: 350 g Head circumference min.: 53 cm max.: 63 cm

• Lightweight with comfort foam • Shock is absorbed by deformation of the expanded polystyrene liner. • Inserts for accepting VIZIR face shield • Slot for Mounting PIXA headlamp • Four clips for mounting a headlamp with elastic headband • Available in 3 colors

Certification(s):

CE*, ANSI Z89.1-2009 Type I Class E

* - Meets the requirements of the EN 397 and EN 12492 standards for protection against impact. - Meets the requirements of the EN 397 and EN 50365 standards for electrical insulation. - Meets the optional requirements of the EN 397 standard for molten metal splash, lateral deformation and use in low temperatures.

2354012012

Color

2354012014

Yellow

2354012019

Red

White



VERTEX™ VENT

Vented for Rescuer Comfort

Comfortable and durable helmet with ventilation, meets requirements for working at height. Adjustable ventilation: 5 holes on each side, can be closed with 2 sliding shutters. Chin strap designed to decrease the risk of losing the helmet in case of impact during a fall. Polycarbonate shell, resistant to impact and wear (meets EN 397 industrial helmet standard and EN 12492 standard). Meets optional requirements of the EN 397 standard: lateral deformation and use at low temperatures (down to - 30 °C).

Weight: 465 gm

Meets CE and ANSI Z89.1 - 2003 -Type I class C.

2354011040

Color

2354011041

Orange

2354011042

Black

2354011044

Yellow

2354011046

Red

2354011049

Blue

White



ALVEO VENT™

Ventilated helmet for work at height and rescue

A lightweight and ventilated helmet for workers at height. Its ventilation holes allow air to pass through the helmet. Its CenterFit adjustment system adjusts the headband and keeps it centered on the head.

Weight: 340 g Head circumference min.: 53 cm max.: 63 cm

• Lightweight with comfort foam • Shock is absorbed by deformation of the expanded polystyrene liner. • Ventilation holes • Inserts for accepting VIZIR face shield • Slot for Mounting PIXA headlamp • Four clips for mounting a headlamp with elastic headband • Available in 3 colors

CE EN 12492*, UIAA, ANSI Z89.1-2009 Type I Class C

* Meets the requirements of the EN 397 and EN 12492 standards for protection against impact.

2354012042

Color

2354012044

Yellow

2354012049

Red

White



Shown w/ R5 Rescue Helmet (not included)

UK 4AA LITE - AS2
Fits Kiwi Light Pods

Extremely bright! Over twice as bright as premium lights of similar size. Provides 4 AA Batteries of power in a light approximating the size of lights containing only 2 AA batteries. Comfortably fits in pocket, briefcase, tool box, and other small places. Optional Helmet mounting brackets attach to industrial, fire, and climbing-style helmets. Burn Time 4-5 hours. Batteries included. FM Approved.

Dimensions: 6" x 1.5" x 1" Weight: 6.4 oz.

485342	UK 4AA Lite - AS2
485349	Spare Bulb for Mini Q-4



HEADS UP LITE
Watertight to 500 Feet

Adjustable beam with large on/off switch. Corrosion proof ABS polymer. 4 AA-cell Alkaline Batteries included. Heat resistant hypo-allergenic silicone rubber strap. Head rotates up and down - special ratchet system holds light in place. Ideal for hard hats and helmets. Includes one high and one low intensity krypton lamps.

Color: Black Weight: 5.4 oz.

UL approved intrinsically safe, CL I, Div. 2, Group ABCD, T3C)

4872600RS	Heads Up Lite
-----------	---------------



PIXA 2
Headlamp with mixed beam, designed for close-range work and for movement

The PIXA 2 headlamp is the hands-free lighting solution for working comfortably at close range and for moving around safely. May be worn on the head, mounted on the helmet, or placed on the ground. It

provides constant, stable lighting performance. Two lighting modes: close-range work: mixed beam with wide, uniform base, lights to 25 meters for 26 hours (20 lumens); Medium range: beam with focused component in upper part of the beam allows user to move around comfortably, lights to 55 meters for 3.5 hours (80 lumens). Reserve lighting when batteries are almost discharged: lights to 10 meters for a minimum of 10 hours. Easy to use, even when wearing gloves: - two-mode rotating selector dial; - lamp body can be oriented to direct the light according to need (rotation up to 45°); - fast and easy battery change. Excellent resistance to falls (2 m), to impacts and to crushing (80 kg). Battery charge indicator flashes repetitive. Resistant to chemicals. Burn time can be doubled by using Lithium Ion batteries or rechargeable Ni-MH batteries. Waterproof to -1 m for 30 minutes.

Weight: 160 g Battery type (included): AA/LR6 Battery compatibility: alkaline, lithium, rechargeable Ni-MH, rechargeable Ni-Cd

Certification(s): - CE - ATEX: CE0080, Ex II 3 GD, Ex nAnL IIB T4; - HAZLOC: class I Groups C & D div II, Class II Group G div II (certifications with alkaline batteries)

2354057802	PIXA 2
------------	--------



PIXA 3
Multi-beam headlamp adapted for close-range work, for moving around and for long-range vision

The PIXA 3 builds upon the features found in the PIXA 2 headlamp and can adapt to any situation encountered on the terrain: close-range work, moving around and long-range vision. May be worn on the head, mounted on the helmet, or placed on the ground. Three lighting modes: - close-range work: wide, uniform beam, lights to 15 meters for 26 hours (20 lumens); - Medium Range: mixed

beam with focused component allows user to move around comfortably, lights to 45 meters for 6.5 hours (60 lumens); - Long-range vision: highly focused beam, lights to 90 meters for 3.5 hours (100 lumens). Reserve lighting when batteries are almost discharged: lights to 15 meters for a minimum of 10 hours. Weight: 160 g. Battery type (2 included): AA/LR6. Battery compatibility: alkaline, lithium, rechargeable Ni-MH, rechargeable Ni-Cd. Waterproof to 1 m for 30 minutes.

Certification(s): - CE - ATEX: CE0080, Ex II 3 GD, Ex nAnL IIB T4 - HAZLOC: class I Groups C & D div II, Class II Group G div II; ANSI/NEMA FL1 (certifications with alkaline batteries)

2354057803	PIXA 3
2354057803R	PIXA 3 Rechargeable



NAO+
Ultra-powerful, multibeam rechargeable headlamp with REACTIVE LIGHTING technology that automatically adjusts brightness and beam pattern.

With REACTIVE LIGHTING technology, the brightness of the NAO headlamp adapts instantly and automatically to the environment. The headlamp thus provides maximal brightness (7 to 575 lumens), a longer burn time, along with greater usability and fewer manual interventions.

The rechargeable Lithium-Ion battery is suitable for frequent use. Weather resistant. Battery: Lithium-Ion 2600 mAh rechargeable battery (included) or 2 AAA/LR03 batteries (not included). Recharge time: 5 hours. Weight: 187 gm. Headlamp comes with rechargeable Lithium-Ion battery and 30 cm USB cable.

Certification(s): - CE - ATEX: CE0080, Ex II 3 GD, Ex nAnL IIB T4 - HAZLOC: class I Groups C & D div II, Class II Group G div II; ANSI/NEMA FL1 (certifications with alkaline batteries).

23541436	NAO
23540536200	ACCU NAO Rechargeable Battery



EOS II LED



The EOS is optimized for both close-up and distance needs. The combination of a Luxeon/1 watt L.E.D. and a special lens maximizes the beam by balancing long throw with flood light. The EOS provides a self-contained 3AAA battery system that eliminates external wires, and is equipped with (3) brightness levels. Each level provides true current regulation ensuring that the EOS will remain at constant brightness as long as the batteries have sufficient voltage. Durable and water resistant to water.

Weight: 3.7 oz with Batteries (Included). Waterproof to 1 Meter. Burn Time: High: 6.5 Hours; Medium: 12.5 Hours; Low: 60 Hours.

UL approved intrinsically safe, CL I, Div. 2, Group ABCD

21851051

EOS II LED

2185105

EOS LED



APEX LED

The Apex LED Headlamp will light up your Rescue world. The 3-watt MaxBright LED (130 lumens) will shine a spotlight beam up to 180 feet away and the four Ultra-bright LEDs will cast a steady wide beam or flashing light out as far as 75 feet. All this power in a 10-oz. package that squeezes 72 to 200 (average 150) hours of light out of four AA alkaline batteries (included). Waterproof to 1 Meter. The dual switch design allows easy access to the five modes. Submersible to 3-feet, works with alkaline, lithium or rechargeable batteries.

UL approved intrinsically safe, CL I, Div. 2, Group ABCD, T3C)

2185101

Apex LED



APEX PRO LED

The Apex Pro lightweight is a must where ultimate power and function are a demand, and durability is an expectation. In an effort to meet the unique and ever evolving needs of rescuers, The Apex Pro was developed to provide a faster and lighter option while still providing the ultimate in brightness and output. The Apex Pro is powered by 2 CR123 lithium batteries protected in a highly durable and waterproof case. 6 power modes.

Burn Time: High Power: 15 hours Low Power: 35 hours Batteries: 2 x CR123 Lithium Weight: 173 gm

UL approved intrinsically safe, CL I, Div. 2, Group ABCD, T4)

2185301

Color

Black



HEADS UP DUAL

Xenon / LED Combination

The Dual combines Pelican's bright Xenon headlamp with a long-lasting set of three (3) LED lamps. Switch controls Halogen and LED lamps. Tilt head offers 90° adjustment. Runs on 3 AA-cell batteries (included). Runs 3 hours on the halogen lamp and 50 hours on the LEDs. Complete with rubber strap.

Color: Black Weight: 4.9 oz.

UL approved intrinsically safe, CL I, Div. 1, Group CD, T3C)

4872620RS

Heads Up Dual



YUKON HL HEADLAMP

Hybrid L.E.D. Technology employs state of the art, 1-watt L.E.D. and 3 high output, 5mm L.E.D.s. The 1-watt L.E.D. rivals the output of incandescent bulbs. For long burn time switch to the 3 L.E.D. array, 10,000 hour bulb life and burn times of 44 hours from the 1-watt L.E.D. and 120 hours from the 3 L.E.D. array.

UL approved intrinsically safe, CL I, Div. 1, Group ABCD, T3C)

488145HL

Yukon HL Headlamp



QUAD HEADLAMP

Four Ultra-bright LEDs power through the darkest conditions. Tough waterproof housing that will survive severe impacts and water submersion up to one meter. Four LED bulbs operate in high, medium, low and flashing modes. Battery power meter with 24 hour burn time on high setting and 47 hour burn time on low setting. Water proof to one meter.

UL approved intrinsically safe, CL I, Div. 2 Group ABCD

UL approved intrinsically safe, CL 2 Div. 2, Group FG

2185201

Quad Headlamp



SUPER SABRELITE
Industrial Quality Work Light



Used by Army and Navy strike teams. High-tech Xenon Laser Spot provides four times the useable candle power of ordinary C & D size flashlights. Unbreakable ABS body with a high impact polycarbonate lens. Includes belt spring clip, stainless steel splitting ring and black lanyard. Meets Military specifications. Requires 3 C-cell batteries.

Dimensions: 7.75" x 1.875" **Weight:** 6.5 oz.

UL Class 1, Div. 1 Approved. FM, MSHA, CSA, AUS, and USAR approved non-incendive.

	Color
48720001	Black
48720000	Orange
48720002	Yellow
4872004	Xenon Lamp Module



STEALTHLITE

Watertight to 500 feet. Unbreakable ABS body with high impact polycarbonate lens. State of the art Laser Spot Xenon lamp module. Includes one-handed safety switch operation, double shock mounted battery compartment, and black lanyard. Operates 5 - 6 hours on 4 AA-cell alkaline batteries (not included.)

Weight: 5.3 oz.

FM, CSA, USAR approved. Class I, Div. I, Group D.

48724001	StealthLite (Black)
48724002	StealthLite (Yellow)
4872404	Xenon Lamp Module



TORRENT LED

Power meets versatility in the Torrent LED. With a 126 Lumen Maxbright LED it's got the power to be a main light source. A simple switching mechanism and a 100-meter waterproof rating ensure that the Torrent LED will be shining bright whenever and wherever you need it to go.

Power: 126 Lumens **Lamp:** Maxbright LED **Burn Time:** 30 Hours **Batteries:** 8 AA Alkaline (not included) **Weight:** 365 Grams

UL RATING APPROVED
Class I Division 2 Groups A, B, C & D

218520102	Torrent LED
-----------	-------------



LITTLE ED™ RECHARGEABLE RECOIL LED™



The Recoil uses a 1 watt LED that's aimed backwards into the reflector. 100% of the light is captured and aimed forward as a tight collimated beam that's as bright as an incandescent. The body is made of tough ABS resin that's corrosion proof and resistant to extreme temperatures. It uses a long-life NiMH battery pack for extended burn time and comes with a charger base unit that can be installed at home or work using the 110V transformer.

Packaged Weight: 1.7 lbs.

48736602	Little Ed, Rechargeable
----------	-------------------------



Clip for windows and cones

E-FLARE™ 500

E-Flare 500 Series: Professional HZ Model

• Rubber Base Included • Fluoro Yellow Body Color • Bright Clear Colors. • Low Battery Indicator • Designed for use in Class I, Div 2/Zone 2 Hazardous areas • 80 hour battery life

23625004	E-Flare, Red
23625002	E-Flare, Amber
23625006	E-Flare, Blue
2362500C	Mounting Clip
2362500M	Mounting Bracket, Magnetic
2362500B	Rubber Base



Shown: LZ Kit, Red/Blue

E-FLARE™ 5 STROBE LZ KIT

5 Strobe E-Flare LZ Kit. Kit includes 1 Blue and 4 Amber or Red Strobes.

23625100	E-Flare LZ Kit, Amber/Blue
23625104	E-Flare LZ Kit, Red/Blue



SECTOR 7 LED DIVE LIGHT

This pistol grip spotlight packs 700 lumens. Eight C-cell batteries (not included) provide 30 hours of burn time. The trigger switch is easy to pull with gloved hands; access momentary on via a half-pull and constant on via a full-pull. The trigger locks out to prevent accidental activation and battery drain while in transit or storage. Waterproof to 100 meters.

Power: 800 Lumens **Lamp:** Maxbright LED **Burn Time:** 30 Hours **Batteries:** 8 C Alkaline **Weight:** 1075 Grams

2185803102	Sector 7 LED
------------	--------------



PRO RESCUE GLOVE

Mesh Back / Leather Palm

The Pro leather gloves are perfect for those jobs that are especially hard on the hands. When anything less than a leather glove won't do. Top quality leather construction throughout. Leather knuckle panel provides increased protection. Easy entry, wide opening elastic cuff (Easy-Fit design). Anatomically-cut, leather palm and heel reinforced panels for extended durability. Smooth surface thumb improves handling of objects. Reinforced thumb and fingertips increase protection and reduce wear.

Weight: 4.8 oz.

	Color	Size	
4912x1	Black	S, M, L, XL, XXL	\$46.00
4912x2	Tan	S, M, L, XL, XXL	\$46.00



HEAVY RESCUE GLOVE

Cowhide shell/Cowhide Wear Pad

Glove design incorporates double palm with wear pad extending up the individual fingers and thumb and around to the back of the hand, leaving a single layer at the finger tips for superior tactile capabilities. This protective design utilizes no loose flaps or webs between the fingers that can trap dirt or roll up during use. Flexible design permits ease in rope handling. Leather loop allows for attachment to carabiners. Berry Compliant

Color: Black Weight: 5.6 oz.

	Size	
4905x1	S, M, L, XL, XXL	\$43.50

BARRIER 1 EXTRICATION GLOVES

A great new extrication / rescue glove. Waterproof and breathable Hipora® barrier to protect hands from micro-organisms such as TB, Hepatitis, Staph and HIV meets O.S.H.A. Bloodborne Pathogens Standards (29CFR 1910.1030). Boxed finger tip design for better fit and comfort. Elastic cuff and gaiter to keep out glass and debris. Molded TPR (Thermal Plastic Rubber) knuckle reduces impact, increases dexterity and features 3M™ Reflective fabric. Molded TPR finger knuckle and finger tip panels. Cut resistant Kevlar® palm and thumb panels, side panels and finger panels. Kevlar® stitching in high wear areas.

	Color	Size	
2022327xx	High-Viz	S, M, L, XL, XXL, XXXL	\$65.00

RESCUETECH GLOVE SIZING

Measure around widest portion of the hand.

XSmall	5 - 7"	Large	9 - 10"
Small	7 - 8"	XLarge	10 - 11"
Medium	8 - 9"	XXLarge	11 - 13"



RINGERS ROPE RESCUE GLOVES

Omni-directional stretch fabric offers flexibility and excellent airflow. Palm manufactured of Armortan® leather that can be machine washed to remove contaminant. Double thickness in palm with DuPont Kevlar® thread for long wear. Reinforced finger tip and thumb extends glove life. Precurved ergonomic shape and anti vibration gel padding for extra comfort.

Weight: 4.8 oz.

	Color	Size	
4907X1	Black	SM - XXL	\$25.00
4907X4	Red	SM - XXL	\$25.00



RIGGING GLOVE

Mesh Shell / Amara™ Palm

Breathable Mesh for Increased ventilation. Smooth surface thumb and index finger improve handling of objects. Reinforced thumb and fingertips increase protection and reduce wear. Neoprene knuckle panel provides increased flexibility and protection. Anatomically cut, foam-padded palm lessens impacts and reduces vibration. Soft, flexible, durable and breathable synthetic leather palm. Easy entry, wide opening elastic cuff. Pull cord on wrist for easy entry and for hanging gloves after use.

Weight: 3.2 oz.

	Size	
4902x1	S, M, L, XL, XXL	19.95



LEATHER 3/4 FINGER GLOVE

Genuine leather, extra gel-foam padding in palm. Great for rigging and stagehands. 2-way stretch spandex top. Flexible, soft, durable and breathable leather palm.

Weight: 3.2 oz.

	Size	
49061x1	S, M, L, XL, XXL	\$29.25



ELASTIC GLOVE CINCH

Manufactured from durable stretch cord and high quality cordlock. Elastic holds gloves in place. Girth-hitch this Cinch around gear loops, waist belts, and D-rings to keep gloves ready to use.

491902

Elastic Glove Cinch



GLOVE STRAP
with Steel Trigger Snap



Manufactured from durable nylon webbing with plated steel trigger snap. Closes around glove with quality hook and loop fastener.

491901

Glove Strap



LATEX GLOVE POUCH



Made from our high quality nylon fabric and top grade hook and loop fastener. Holds multiple pairs of gloves.

833001

Latex Glove Pouch



USAR KNEE AND ELBOW PADS

Great for use in building collapse searches. Velcro closure and tough cap. Provides heavy duty protection for the toughest jobs.

Both Standard and Gel versions feature durable thick flexible cap that provides traction, and resists skidding; and AltaLOK™ Easy On/Off Fastening System.

Standard version features black cap and cordura nylon cover with compression recovery 1/2" Neoprene foam padding that provides firm, consistent support without bottoming out.

Gel Version features Gray Cap with gray and orange cover and Gel Insert for extra comfort



		Weight
481611	Knee Pad, Standard -pair	13.7 oz.
481612	Knee Pad, Gel - Pair	
481621	Elbow Pad, pair	7.2 oz.



EMT SHEARS POUCH

A new design from Rescue Technology. Made from Durable Magnatuf coated nylon fabric. Features glove pouch, shears pouch with hook and loop keeper and a pouch for penlights, pens, etc. Fits onto belts with a quick removable snap system. A plus for safety. Shears not included.

833010

EMT Shears Pouch



SEAT BELT CUTTER

A lightweight seat belt cutter. Will easily cut through webbing and cords with ease. Manufactured from high impact plastic with hardened stainless steel blade.

Dimension: 4.75" x 1.75" Weight: 1 oz.

630101

Seat Belt Cutter



EMT SHEARS



Safer than a knife when used around ropes. Safety bandage tip. Stainless Steel Blades. May be placed in Autoclave. Cuts clothing, ropes, or harnesses. Stainless Steel blades with polypropylene handles.

Length: 7.5" Weight: 2 oz.

6301051

EMT Shears

Color

6301052

EMT Shears

Black

Yellow



WINGMAN

The Wingman Knife's flip-out blade fulfills your need for speed. Its safety features help you break out of the danger zone. Easily deployable one hand flip-open blade for when you feel the need for speed. Knife has a blunt tip and both smooth and serrated blade sections. The blade locks open for safety and the handle has a blunt glass-breaking tip. Removable spring steel clip is always ready for action when secured to a belt or lash tab.

20842771 Wingman \$32.00



CAPTAIN RESCUE KNIFE

The folding, lock-blade NRS Captain Rescue Knife is a great choice for guides and swiftwater rescue professionals. Features a rope cutting hook at the tip and a quick-slicing serrated edge. A spring metal clip keeps the knife where you want it, or you can remove the clip for a sleeker profile. Blunt tip also serves as a slot screwdriver. Lanyard hole lets you conveniently tether the knife to prevent loss.

Overall Length: 7.5" Blade Length: 3" Weight: 2.8 oz.

208447307 Captain's Knife 40.00



SPYDERCO RESCUE KNIFE

VG-10 blade steel and fully serrated with a sheepfoot tip. Large thumb hole with texturing behind it and the FRN volcano grip textured handle.

Blade thickness: 1/8"

	Length	Length	Color	
2282376553	7 1/8"	79mm	Orange	\$99.00
2282376530	8 1/8"	93mm	Black	\$120.00



KERSHAW BLUR SERRATED

The Blur's handle is built from anodized 6061-T6 aluminum with "Trac-Tec" inserts for an extremely secure grip even in the most damp or slippery conditions. The blade is made out of 440A stainless steel and measures 3". Easy opening with Speed Safe technology. Folded, the blade measures 4.25" and weighs in at a comfortable 4 oz.

2282376796 Serrated (Black) \$104.00



E-Z OUT RESCUE

The E-Z Out Rescue features a blunt tip design on the fully serrated sheep foot stainless blade that makes this knife safer to use in situations where you don't want to risk puncture. Features a yellow handle with black Kraton® non-slip rubber inserts, removable pocket clip and lock back.

Closed: 4.62" Blade: 3.5" Weight: 2.6

2282376647 E-Z Out Rescue \$48.00



SPYDERCO ASSIST RESCUE KNIFE

With Glass Breaker

Made for the fire/rescue professionals, the Assist features a carbide glass breaker, sure grip FRN handle, 80% serrated blade, VG-10 high-carbon blade steel, survival whistle built into the handle and wire clip. Blade and handle shape are designed to allow controlled rope cutting without an exposed cutting edge. Place the rope between the partially closed blade and the handle then squeeze the blade shut.

Length: blade 3.69" closed: 4.875" Weight: 4 oz.

2282376549 Assist \$135.00



GERBER HINDERER

It took a fire fighter with a genius for knife design to conceive this feature-rich rescue knife. And Rick Hinderer did himself proud. He's integrated some of the most important features a fire fighter will need. Even while wearing turn-out gloves, using this knife will not be an issue. The knife has larger, beefier features and mechanisms built-in. This is no ordinary rescue knife. The Hinderer Rescue Knife has a heavy duty, 440A stainless steel blade with an external blade release. Additional features include an oxygen tank wrench, safety hook cutter, window punch, lanyard hole and an oversized thumb stud for easy opening. And it comes with a 9-piece tool kit. The belt case can be worn vertically or horizontally.

Blade Length: 3.5" (89mm) Open Length: 8.5" (215mm) Weight: 5.6 oz. (158g)

243601534 Gerber Hinderer \$105.00

FIELD OPERATIONS

RESCUER ASSISTANCE & COMMUNICATION

All teams performing Search and Rescue in Urban, Suburban and rural areas benefit from the capabilities of hardwire communications and remote cameras. Con-Space is the preeminent manufacturer of top quality search products. From their original hardline communications kits to the Delsar life detectors to the Searchcam remote camera products, you can be sure of the quality and durability of Con-Space products. Used by USAR teams



CON-SPACE COMMUNICATIONS SYSTEMS

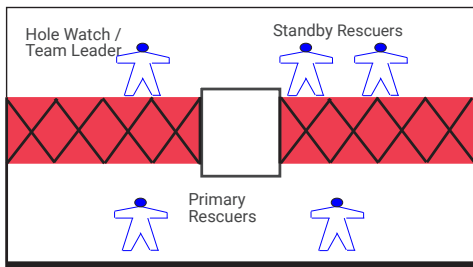

RESCUE COMM KIT 1P

Configured for a team of five rescuers consisting of two primary entrants, two standby entrants and a safety attendant. Includes 100' of cable for each entrant (expandable to 1500 ft.). System can be configured for up to ten people using available modules and accessories.

Weight: 49 lbs.

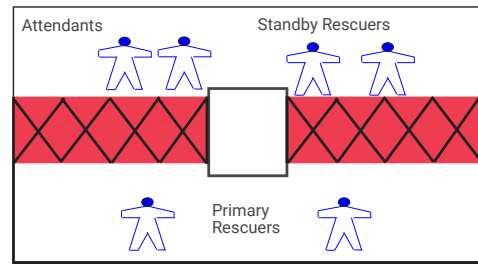
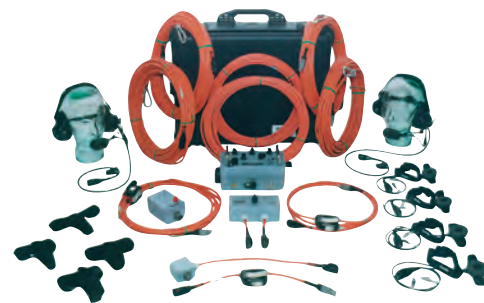

RESCUE COMM KIT 5P

Configured for a team of six rescuers consisting of two primary entrants, two standby entrants and two attendants. Includes 100' of cable for each entrant (expandable to 1500 ft.). System can be configured for up to fourteen people using available modules and accessories.

304011P

Rescue Kit 1, Power Talk

304015P

Rescue Kit 5, Power Talk



USAR TASK FORCE COMMUNICATION KIT

A multi-use Urban Search and Rescue Task force Kit designed to meet the needs of Confined Space, High Angle, Structural Collapse, Victim Location, Shoring, Tunneling and Trench Rescue. The USAR Kit can be configured according to the type of rescue involved, so whether it's a two-in-two-out or a five person Search and Rescue team this kit has you covered. Intrinsically Safe.

3034055

USAR Task Force Comm Kit



VICTIM LOCATOR KIT
Confined Space Rescue Probe

For structural collapse - includes the unique CON-SPACE Rescue Probe designed to detect and communicate with victims trapped in collapsed structures. Intrinsically Safe Approved.

30310031

Victim Locator Kit



DELSAR LIFE DETECTOR LD3

Rescue teams around the world have relied upon the LifeDetector for over 15 years to rapidly detect and locate victims of collapsed buildings. The LifeDetector essentially converts the entire collapsed structure into a large sensitive microphone to pinpoint signals from the entombed victims. The seismic and acoustic sensors of the system convert vibrations created by the live victim into audible and visual signals.

- Improved color-coded cable connectors
- Allows two acoustic search probes to be used simultaneously for stereo comparison.
- Audio loop record function records last five minutes of audio for playback and comparison.
- Display panel shows relative signal strength of all six sensors simultaneously.
- Peak meters indicates highest amplitude reached by each sensor.

21709920306	6 Sensor
21709920304	4 Sensor
21709920302	2 Sensor
2170996020	Delsar Mini-S Kit
21709920311	Delsar Victim Simulator

DELSAR USAR SEARCH KIT

The New Delsar USAR Kit combines the Delsar Life Detector Six Sensor System and the Delsar Victim Simulator, together in one ready to deploy case. The Victim Simulator) is an excellent training tool for victim search and rescue, but also doubles as a valuable calibration unit for the Delsar's Seismic Sensors for use on different surface materials. Used by FEMA, UKSAR, USAR, SUSAR and rescue teams from around the world, the Delsar USAR Kit is a seismic/acoustic listening device used to detect and locate live victims trapped in:

- Collapsed structures caused by earthquakes
- Explosions
- Landslides
- Mine disasters or cave-ins

The Delsar USAR Kit converts the entire collapsed structure into a large sensitive microphone that transmits noises from entombed victims. The seismic and acoustic sensors convert vibrations created by the live victim into audible and visual signals. The Delsar is rugged, reliable and able to withstand days of continuous use at the disaster site.



21709920320

Delsar USAR Kit



HOSE/CABLE UMBILICAL
Zippered in Multiple Colors

New style zippered hose / cable protections. Four colors to allow accurate selection of hose/cable/lifeline combinations.

50'	Color	100'	Color
303010501	Black	303011001	Black
303010500	Orange	303011000	Orange
303010502	Yellow	303011002	Yellow
303010506	Blue	303011006	Blue
303010504	Red	303011004	Red



CABLE AND ACCESSORIES

30204050	50' w/ Connector
30204100	100' w/ Connector
30311050	50' w/ Strain Relief Hook (shown)
30311100	100' w/ Strain Relief Hook



WARNING

Technical rescue and safety is potentially hazardous. Any person using equipment sold by RESCUE TECHNOLOGY in any manner is personally responsible for learning the proper techniques involved, and assumes all risks and accepts full and complete responsibility for any and all damages or injury of any kind, including death, which may result from the use of any RESCUE TECHNOLOGY equipment



CABLE / AIR HOSE REEL

Communicate while reeling in or out. Cable is fully protected, easily handled, and safely stored. Cable & Hose not included.

30120530	300 ft. Reel with Wheels	\$2,985.00
----------	--------------------------	------------



CABLE REELS

Communicate while reeling in or out. Cable is fully protected, easily handled, and safely stored. Cable & Hose not included.

30120225	250 ft. Reel
30120250	500 ft. Reel



CON-SPACE CABLE BAG

Stores and allows for easy transport of your Hardline Cable. Holds 100 ft. - 300 ft. of Con-Space Cable. Cable not included.

Dimensions: 32" L x 11" W x 6" H

30303007	Con-Space Cable Bag
----------	---------------------



CON-SPACE HASTY SEARCH KIT

The HASTY SEARCH Kit™ has been specifically configured for urban search & rescue teams, “enhanced” rescue squads, regional task forces and SUSAR teams who are seeking a high quality, easy to use, cost effective, all-in-one technical search system for their standard equipment cache. The Hasty Search Kit comes complete in one easy to store case and is designed to be both easily transportable and rapidly deployable anywhere disaster strikes.

The Kit includes the Delsar® LifeDetector® Mini system that provides seismic detection of victims and the all new SearchCam Recon III for visual search and location operations.

21709922001

Con-Space Hasty Search Kit



SEARCHCAM 3000™

The new standard for Technical Search and Rescue Cameras

Lightweight and portable, the SearchCam 3000 is constructed using aircraft aluminum with a hard anodized finish. The interchangeable tube sets connect using threaded couplers - enlarged to ensure easy of use while wearing gloves. The unit features significant improvements over the SearchCAM 2000.

Record Video, Voice and Still Images. Detachable head is waterproof and can be lowered into dusty, harsh and wet void spaces. Articulating camera head is power driven with a high precision, clutch protected motor with steel gears and ball bearings.

Components Included:

• Power Module • Standard Tube Set • Gearbox/Audio module • Environmental Sleeve for Audio Module • Color Camera • Video display Unit VDU • Headset • 4GB SDHC Card • Waterproof Storage case • 75' Camera Extension Cable • 70' rope w/ Carabiner • Camera Head Rope Coupler • Lithium ION Batteries (4) • Gang Charger • Sun Shield • Tube Strap • VOID Orientation Guide

21709930001

Probe w/ Audio



RECON III SEARCH CAMERA

The Recon III camera has been completely re-designed to provide unparalleled reliability, durability and ease of use to meet and exceed the operational requirements of a rescue squad or medium/light USAR capability. Building upon the success of the popular Recon II, the Recon III fits today's demanding requirements and more demanding Budgets. The New Recon III is affordable, versatile and ready to go! The Recon III utilizes a 240 degree articulating camera head with variable high output LED lighting to achieve effective visual searching as close as a few inches to over 10 feet (3m) in total darkness. The display is attached to the control housing with a quick connect fitting and can be easily removed to extend the cameras reach. Articulation is accomplished by rotating the large glove friendly drive collar. The pistol grip handle makes positioning and handling intuitive and provides an easy reference for camera head orientation. The lack of external wires and belt packs make the Recon III camera extremely maneuverable and portable. The Recon III is compatible with batteries and chargers of the SearchCam 3000 and Delsar LD3 and Delsar Mini Systems to aid with logistics on a large scale event. The Recon III is designed for rescue squads that understand the value of an adaptable visual search tool that can be used in a wide variety of operations and want the quality and features found only in a SearchCam product.

21709920103

Recon III Search Camera



Shown with HT-1250 Radio. (Not included)

DOUBLE RADIO CHEST HARNESS

Same suspension and adjustment as the Deluxe Radio Chest Harness. Carries two radios, one on each side of platform with a center pocket for extra batteries, etc. Second radio pocket can also carry GPS unit or cell phone.

Weight: 12 oz. Color: Black



820321

Double Radio Harness



Shown with HT-1250 Radio. (Not included)

MESH RADIO CHEST HARNESS

Lightweight, Breathable

A lightweight version of our Deluxe Radio Chest Harness. Adjustable webbing shoulder straps with quick-adjust elastic chest strap. Mesh provides excellent ventilation for hot climates. Elastic loops hold pens, flashlights, etc.

Color: Black Weight: 7.2 oz.



820305

Radio Chest Harness



Shown with HT-1250 Radio. (Not included)

HARNESS RADIO HOLSTER

A holster that puts your hand-held radio where you need it – on the shoulder strap of your harness. Fully adjustable for radio circumference and height. Attaches with high strength hook and loop. User adjustable elastic sizes for the height of the radio and closes with a high strength Snap.

820307

Harness Radio Holster



Shown with HT-1250 Radio. (Not included)

DELUXE RADIO CHEST HARNESS

One-Size-Fits-All radio harness will adjust to hold any radio snugly to your chest. The vertical orientation of the radio improves reception, extends antenna life, and reduces the chance of chest injury during a fall. The unique suspension system of 1.5" webbing shoulder straps and elastic chest strap, virtually guarantees that the harness will not bounce or swing, even while crawling through confined spaces. Twin buckles ease the donning of the elastic chest strap. The harness features a large bellows cargo pocket, pen pouch, and twin elastic antenna keepers.

Color: Black Weight: 9.6 oz.

820301

Deluxe Radio Chest Harness



RAMFAN UB20
8" Blower System

Provides the industry's highest certified CFM for either exhausting or discharging air with 8" duct. Easily attached 15 - 25 ft. duct canister works at either end or both ends. The UB-20 has RAMFAN's uniquely designed turbo blade which creates a straight, non-spiraling airflow. Motor: 1/3 hp, 60 Hz, 115 - 230 VAC, 2 amps. Optional DC motor. Manufactured of Double Wall lightweight, rugged polyethylene.

Dimensions: 13" H x 12" W x 13" D Weight: 16 lbs.
Performance measured by CEESI.

	Airflow		
	Freeflow	1-90°	2-90°
	980 cfm	789 cfm	666 cfm
3270015	AC Blower w/ 15 ft duct		
3270025	AC Blower w/ 25 ft duct		
329015	DC Blower w/ 15 ft duct		
329025	DC Blower w/ 25 ft duct		
325508	AC Blower ONLY, 115 v		
329002	DC Blower ONLY, 12 v		
3203605	DC Battery Connector, 5 ft.		
32034214	UB20 DC Battery Pack Charger		



RAMFAN UB30
12" High Output Blower

A new 12" RAMFAN is born. Building on "UB" technology, the patent-pending UB30 is simply the toughest, most durable, easy to maintain and versatile blower in its class. Unmatched performance, dual voltage-dual frequency versatility, tough polymer shell and turbo-impeller design makes for an unbeatable package.

• Thermal Switch provides Overheat Protection • IP65 Rain Tested Switch Enclosure • Ultra Quiet Operation Low Starting

	Airflow		
	Freeflow	1-90°	2-90°
	2,873 m3/hr	2,550 m3/hr	2,340 m3/hr
329102	12" UB30 Blower		
3210112	12" - 8" Duct Adaptor		



RAMFAN EXTREME HAZARD BLOWER

Same high quality blower mechanism as the standard UB20 with a conductive housing and duct. When properly grounded, the system virtually eliminates static discharges. Manufactured with Anti-Static housing. Totally enclosed hazardous location motor rated UL Class I, Group C,D; UL Class II, Group E,F, G. 30 ft. Cord w/ power switch.

Blower Dimensions: 13" H x 12" W x 13" D Blower Weight: 21 lbs.

Performance measured by CEESI. Plug not included.

3270102	8" UB-20XX Blower ONLY
327512X	12" Efi75XX Blower ONLY
3270115XK	UB-20XX w/15 ft duct/Kil-Arc Plug
3270125XK	UB-20XX w/25 ft duct/Kil-Arc Plug



RAMFAN ACCESSORIES

8" Duct	
320815	Standard Duct, 15 ft.
320825	Standard Duct, 25 ft.
320815C	Conductive Duct, 15 ft.
320825C	Conductive Duct, 25 ft.
3210108C	Duct Coupler, 8"
12" Duct	
3211215	Standard Duct, 15 ft.
3211225	Standard Duct, 25 ft.
3212215	Conductive Duct, 15 ft.
3212225	Conductive Duct, 25 ft.
3210112C	Duct Coupler, 12"
321015	Duct Storage Bag



RAMFAN M.E.D. 8" BLOWER SYSTEM
Complete Confined Space System

Ready-built system for your confined space team. Available with Standard UB20 Blower or UB20XX Extreme hazard Blower and 5 ft. and 15 ft. duct.

220370152	20' System
327025XS-S	20' Hazard System
327025XS-K	20' Hazard System w/ Kil-Arc Plug

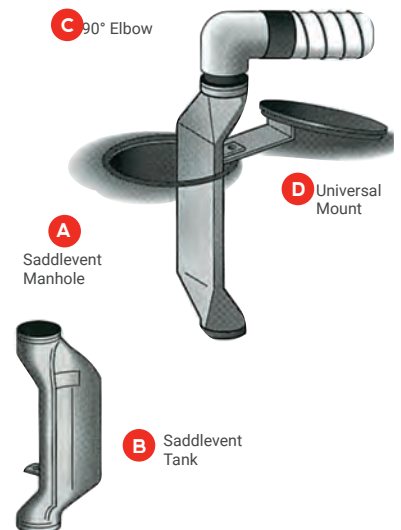

SADDLE VENT
For Use With 8" Duct

A. 3220189	Manhole, Std.
A. 3221189X	Manhole, Conductive
B. 3220189T	Tank, Std.
C. 3220190	90° Elbow
C. 3221190X	90° Elbow, Conductive
C. 3220190T	90° Elbow, Tank Style
D. 322098	Universal Mount

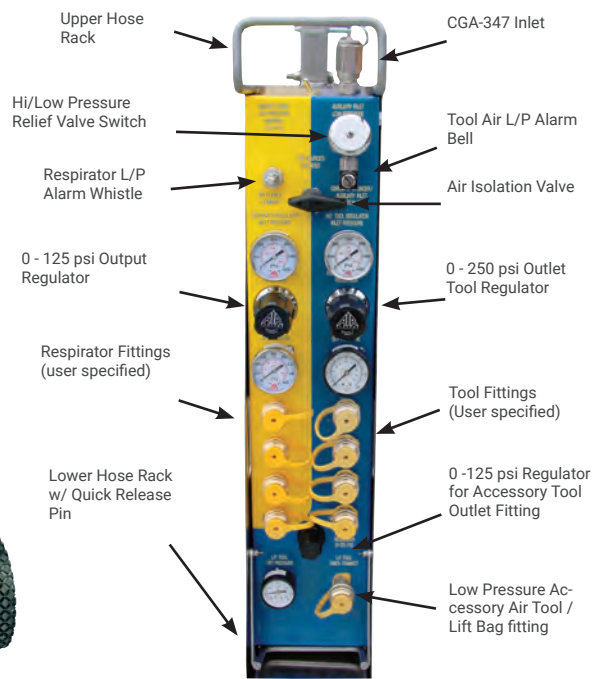

TECHNICAL RESCUE AIR CART
Simultaneous Respirator and Air Tool Operation

Separate high (275 psi) and low (125 psi) pressure regulated air systems. Additional high pressure inlet port allows connection to outside air source for extended use applications. High pressure isolation valve and toggle switch allows user to switch between common or isolated air sources. Operable via cylinder air or mobile air truck. The system includes two connecting hose whips with bleed valves and inline check valves, adjustable heavy duty high flow pressure regulator with relief valve, dual pressure gauges for cylinder and outlet pressure readings, low cylinder pressure alarm, breathing air manifold with quick-disconnect Hansen couplings. 275 psi or 125 psi pressure relief valve. 3 way selector valve allows operation with left cylinder, right cylinder, or High Pressure Inlet. Dimensions: 35"H x 20.5" W x 15" D. Weight: 54.5 lbs (without cylinders). Respirator Regulator: 0 - 5500 psi inlet; 0 - 125 psi outlet. Tool Regulator, High Pressure: 0 - 6000 psi inlet; 0 - 275 psi outlet. Tool Regulator, Low Pressure: 0 - 300 psi inlet; 0 - 125 psi outlet. Flow Rate: 80 cfm @ 120 psi. Outlet Fittings: four (4) 1/4" Quick-Disconnect Fittings. Accepts cylinders up to 4500 psi pressure rating. Exceeds NIOSH guidelines for point of attachment.

2009114H
 2009225
 2009119

Technical Rescue Cart, 1/4" Hansen Fittings
 25 ft. High Pressure Connect Whip (for Cascade)
 Cart Cover



MACK NFPA AIR MANIFOLD
Air Distribution System Designed Specifically for Confined Space Rescue Teams

The MACK-NFPA series has been developed specifically for the Fire/Rescue teams working under NFPA guidelines. Two separate regulator/manifold systems provide 0-125 psi air to a four outlet respirator manifold. Two SCBA connect whips are provided for each regulator for SCBA cylinder attachment (not included). In the event of regulator malfunction, rescue can be performed on the standby regulator system. A CGA-347 high pressure inlet is also provided to allow continuous operation from truck mounted air cylinders. Low pressure alarm whistle and a 6 volt DC lamp to illuminate the case interior are standard. The MACKNFPA3, has a regulator isolation valve added to allow one or both air sources to be used simultaneously.

- Dual independent regulators with two 3-outlet manifolds
- Dual low pressure alarms
- 4 each 5 ft. connect whips
- Regulator Isolation Valve
- CGA-347 High Pressure Inlet



AIR SUPPLY HOSE

High quality air supply hose with Hansen fittings to fit the Technical Rescue Air Cart.

20095457H
 20095458H

50'
 100'

2009133NH

MACK-NFPA 3, Hansen Fittings

RescueTECH
251 Beulah Church Road
Carrollton, GA 30117
Phone 800.334.3368
Fax 770.832.1676
www.rescuetech1.com

PRST STD AUTO
U.S. Postage
Paid
Carrollton, ga
permit no. 356

RESCUE

TECH
TECHNICAL RESCUE GEAR